

# **San Clemente in Rome**

A New Reconstruction of the Early 5th Century  
Basilica and Its Origins

Juhana Heikonen

Dissertation (Ph.D.) for the Department of Architecture

School of Arts, Design and Architecture

Aalto University

2017

Aalto University publication series

DOCTORAL DISSERTATIONS 60/2017

School of Arts, Design and Architecture

Aalto ARTS Books

Helsinki

[shop.aalto.fi](http://shop.aalto.fi)

© Juhana Heikonen

Design: Juhana Heikonen

Materials: Cover Scandia 2000 natural 300 g/m<sup>2</sup>, pages G-Print 100g

Fonts: Times New Roman

ISBN 978-952-60-7365-1 (printed)

ISBN 978-952-60-7364-4 (pdf)

ISSN-L 1799-4934

ISSN 1799-4934 (printed)

ISSN 1799-4942 (pdf)

Printed at Unigrafia, Finland

2017

## Abstract

### San Clemente in Rome

#### A New Reconstruction of the Early 5th Century Basilica and Its Origins

The Basilica of San Clemente in Rome has a long history. The present day 12th century church was thought to be the early Christian basilica mentioned by Jerome until the excavations in the 19th century. The still ongoing archaeological excavations at the site have exposed not only the “Lower Church” of the 5th century but also a *horrea* and a *domus* with a *Mithraeum*, reaching republican layers of Roman urban history.

From the second half of 19th century on, the studies of San Clemente are numerous. Important names of architectural history and archaeology, such as Richard Krautheimer and Federico Guidobaldi, have made an enormous impact on the study of early Christian churches and San Clemente in particular. The 20 different building phases of the site are entangled and complicated and some of them have been erased almost completely during the last two millennia.

The main theme of my dissertation concerns the building phases from the 3rd century throughout the 5th century when the first proper Christian basilica was finished. There have been conflicting theories about the function of the 3rd century building. The first theories saw St. Clement’s house church transformed into a *domus ecclesiae* and further to an *aula ecclesiae* and finally into a regular basilica below the present San Clemente. Several theories have been discussed and abandoned, but there are still unanswered questions about the 3rd century building’s function – whether it was an Imperial mint or a private building.

The aim of this dissertation is a set of sequenced reconstructions of San Clemente along *The London Charter* principles of virtual archaeology through the typological developments of the Roman basilica and the late antique *domus* as a source of Roman *Sakraltopographie*.

The aim of the dissertation is to shed light on these unanswered questions by creating new reconstructions of San Clemente and its urban context in 3D-models and GIS-based cartography. The bulk of Roman early Christian churches that were built in a hundred years time (350-450 AD) constitute a vast source of comparative material for my research. The data of the early Christian Roman basilica in general has been processed in typologies and tables with the aim to find the similarities in building history and urban location. This material is used along with the more traditional comparative evidence of literary sources.

In the last decades the research of the late antique *domus* has developed greatly (Simon Ellis, Kimberly Bowes etc.). The relation of the *domus* to early Christian architecture has also been viewed in a new light in topographical, architectural and socio-economical terms. My conclusion, that the *aula ecclesiae* (a church built in the public space of a *domus*) was in fact the first building phase of San Clemente, is further based on late antique Roman urban history as well as the history of private patronage and ecclesiastical history.

# Table of Contents

<b>Foreword</b>	<b>5</b>
<b>Introduction</b>	<b>5</b>
<b>1 San Clemente in Rome</b>	<b>22</b>
1.1 Previous Research	23
1.2 The site, its building history and urban context	30
1.3 Literary references to San Clemente up to the 12th century	53
<b>2 The Roman basilica and its urban context</b>	<b>55</b>
2.1 The civic basilica	56
2.2 The Christian basilica	63
2.3 Literary evidence on basilica from Vitruvius to Paulinus of Nola	88
2.4 Other evidence concerning the appearance of Christian basilicas	106
2.5 The Roman basilica in its urban context	115
2.6 Conclusion	116
<b>3 The Late Antique <i>domus</i> and the <i>titulus</i></b>	<b>120</b>
3.1 The late antique <i>domus</i>	121
3.2 Literary evidence for the late antique <i>domus</i>	133
3.3 The 4th century <i>domus</i> and <i>titulus</i> in Rome	138
3.4 Conclusion	147
<b>4 Reconstruction and Conclusions</b>	<b>150</b>
4.1 The archaeological remains of the 5th century basilica and its earlier reconstructions	150
4.2 Measurements and reconstructions	152
4.3 Conclusions	166
<b>5 Appendix I</b>	<b>168</b>
<b>Appendix II</b>	<b>185</b>
<b>6 Bibliography</b>	<b>193</b>
<b>7 List of illustrations</b>	<b>205</b>
<b>8 Drawings, Maps and Tables</b>	<b>211</b>

## Foreword

For the past few years I have been a member of a University of Helsinki based research project *Public and Private in the Roman House* (PPRH, led by Dr. Kaius Tuori). I will also be ever grateful to the Finnish Institute in Rome (Institutum Romanum Finlandiae) under the roof of which the majority of this dissertation was written.

The following foundations supported my work during the last decade: Alfred Töpfer Stiftung F.V.S. (Hamburg), Wihuri-foundation (Helsinki), Emil Aaltonen Foundation (Tampere), The Helsinki University of Technology Foundation (Espoo) and the Finnish Academy.

I owe special thanks to the guiding Professors Aino Niskanen and Kaius Tuori. And also to the pre-examiners Professor Olof Brandt and Dr. Eeva-Maria Viitanen without whose valuable critique this dissertation would never have finished. An important part of the help received has been Professor Eva Margareta Steinby's ever patient and extensive reading and correcting my mistakes, for which I remain ever grateful. And last but not least Dr. Margot Stout-Whiting, Heta Björklund and Aino Ruutu, without whose editorial help this dissertation would not be readable

I will also be ever grateful to Seamus Tuohy O.P. of San Clemente who kindly helped me at San Clemente - the subject of this dissertation.

## Introduction

The aim of this dissertation is a sequence of reconstructions of San Clemente along *The London Charter* principles of virtual archaeology through the typological developments of the Roman basilica and the Late Antique *domus* as a source of Roman *Sakraltopographie*.<sup>1</sup>

I present a set of reconstructions of San Clemente around the year 400 and my hypothesis of how it developed into the famous basilica. The reconstruction is based on a meticulous investigation of archaeological, written and comparative evidence. The history of architectural reconstruction drawings is a very rich one, and even up to the present some of the reconstructions still operate in the realm of fantasy without any justification. For this reason I endeavor to give analytical reasons for the decisions I have made. The main idea is to consider the basilica as a building type, which is discussed in the second chapter of this dissertation based on archaeological and literary evidence. This dissertation presumes that the early Christian architecture in Rome was also influenced by the Late Antique *domus*. The public and private nature of the Republican *domus* continued through Roman

---

<sup>1</sup> All dates are in AD unless otherwise indicated.

late antiquity and its public features (religious, magisterial etc.) remained.<sup>2</sup> This is to show the way the building type developed up to the time of the building of San Clemente.<sup>3</sup> This typology is vital when assembling the comparative evidence for the reconstruction. After the reconstructions and typologies are presented, I move backwards and compare the results with the typology itself and consider the developments following the change in the function of basilica from secular to ecclesiastical and what role the Roman *domus* played in this process. The changes concerned the physical form of the basilica, its placement within the urban topography of Rome and between public and private. What remained and what changed during the 500 years of this development in Rome can be best answered through San Clemente, since it is widely considered to be a “standard basilica” of its time in the Roman Empire. Furthermore, might the 19th century German theory, later abandoned, of the role in spatial organization of the “classical” *domus* as the starting point for the early Christian place of cult still play part? This theory persists among some ecclesiastical historians.<sup>4</sup> There is certainly a relationship between the late antique *domus* and the early Christian church in Rome. This dissertation explores the birth of one early Christian basilica from its preceding structure in the context of its peers and it is based on new 3D-models, drawings, tables and maps created by the author.

There are still disagreements about the early phases of San Clemente. The latest one was fostered by Filippo Coarelli, suggesting that in its 3rd century phase it was the imperial *Moneta* (Phase IV in Chapter 1.1).<sup>5</sup> Since the function of San Clemente’s previous building phases and development to an early Christian basilica still remain open, I shall offer my hypothesis of the building history.

How much influence did the preexisting *domus* (or two) have on San Clemente? How much did the previously existing residential structures affect the Roman Late Antique *Sakraltopographie* and is this unique to Rome? How does the early Christian basilica relate to the *domus* in late antiquity both in spatial arrangement and interior design? For these questions, along with the methods described below, I also take a new critical look at the published research material, which is especially inadequate on reconstructions. This dissertation also suggests a solution to the before mentioned problems by introducing a new phase to those previously presented that would also align with the Roman architectural history of the *domus*, which was converted into a church. This is achieved and augmented along the guidelines of *The London Charter* of visual archaeology and the

---

<sup>2</sup> Tuori 2015, 7-15.

<sup>3</sup> The church of St. Clement’s will be called San Clemente, as Joan Barclay-Lloyd has also done.

<sup>4</sup> White I 1990, 15.

<sup>5</sup> Coarelli 2007, 172-176. A surprisingly long description in *Rome and Environs - An Archaeological Guide*.

chosen methodology.

What new findings does this study offer? First, it presents a new reconstruction based on accurate modern measurements, replacing Krautheimer's 1930s reconstruction of San Clemente. This new reconstruction is an unprecedented virtual model detailing not only the building design but also its interior and exterior. It suggests an amendment to the building history of San Clemente by introducing Phase IVb. Second, it outlines for the first time in detail the connections between changes in urban topography around the site and San Clemente itself. Third, it situates the early Christian Church in its complex relationship with both the private *domus* and the Roman basilica as building types. It is supported with a comprehensive list of early Christian churches in Rome and their detailed relationship with the late antique *domus*.

In addition to a lengthy fieldwork period, this dissertation has required studies in architectural history, classical history and archaeology and has benefited from all these fields. For the reconstructions, however, the main field of operation is architectural expertise, which has been used for both the on site measurements and for the final part of the reconstructions of the basilica itself<sup>6</sup>. In this sense, this dissertation is cross disciplinary. It can also be considered as an architectural design process although nothing has been designed but more as though I have redrawn what might have been designed using the guidelines of archaeological and other evidence. Although the reconstructions and plans cover only a few of the pages, they are the lion's share of the dissertation's end result. In many ways, the text plays a supporting role, explaining to the reader how and with what means they are achieved in order not to repeat the major fault of many (but not all) archaeological and art historical reconstructions of the built environment throughout history – weak evidence and unclear justification for the reconstructions. On the foundation of solid and better reconstructions, more speculative reconstructions and “artist's views” can be produced.

#### *Reconstructions as a method*

Archaeological *reconstructions* are actually two different things in literature: actual physical reconstructions or virtual reconstructions. In archaeology, physical reconstructions on site are seldom made and have been considered harmful for a long time except in a situation where they provide protection for the archaeological remains.<sup>7</sup>

The history of archaeological reconstructions, the subject of this dissertation, is long

---

<sup>6</sup>The author is also a professional architect.

<sup>7</sup>The reconstructions of actual fragments made on site, for example in Ephesos are nowadays considered as harmful.

and wide. In general, the history of archaeological reconstructions is a less studied subject. However, the history of archaeological reconstructions is not the subject of this dissertation, though it would be still important to note, that the story of the reconstruction actually started in biblical archaeology.

As an example, Solomon's temple was deconstructed and reconstructed in real life as well in virtual life. The first one already happened in antiquity. The spiral columns of Solomon's temple were a continuing fascination up to the Baroque period. The appearance of the temple fascinated medieval architects, clerics, reliquary makers, freemasons and politicians. The results were determined by political or religious motives. The first scientific attempt to reconstruct Solomon's Temple virtually was done by no less than Isaac Newton himself at the end of the 17th century and it is preserved in a manuscript (Babson M0434 and M0424). Tessa Morrison has presented a modern version of the reconstruction in Newton's manuscript with the help of ArchiCAD<sup>8</sup>. Needless to say, the long history of Solomon's Temple reconstructions is an ongoing process.

Another good example of using different methods of reconstruction would be the 5th century Southern Church of Bawit in Egypt (Fig. 0.05, 0.06 and 0.07). The site was originally discovered by Jean Clédat in 1901 and has been excavated by the French ever since. A large proportion of the finds were donated to the Louvre before World War I. During the 1990s the Louvre rearranged the finds and built a complete department presenting the excavation history and its context. First of all, they built a scale model of the Southern Church with the excavation documentation and a 3D-model to accompany it. Since the French had already transported the remaining architectural fragments (capitals, tympanums, frescoes etc.) a 1:1 scale reconstruction of the basilica was also built in the basement of the museum. This has been extremely rare since the displays of the Zeus altar and the city gate of Miletus in the Pergamon Museum in Berlin<sup>9</sup>. The finds will be discussed in Chapter 2.4.

Vitruvius was the great hero of Renaissance architects and was used as an inspiration since Carolingian times according to the earliest surviving manuscripts of *De Architectura*. As proof of this, the clumsy Ionian capitals of Sankt Mikael in Fulda would correspond with those of San Clemente's atrium displaying the need to imitate classical antiquity.

Archaeological reconstruction illustrations have been discussed on an academic level during the past decades. The importance of 3D-documentation has also been discussed<sup>10</sup>.

---

<sup>8</sup> Morrison 2011.

<sup>9</sup> Bénazeth 2002.

<sup>10</sup> De Reu et al. 2014, 251-262.



Juan A. Barceló, Maurizio Forte and Donald H. Sanders in the introduction of their *Virtual Reality in Archaeology*, summarize the essence of archaeological reconstructions as *Image construction is a reasoning process. Our brain builds images by processing knowledge in specific ways. Because of the quantity of information computer visual models can explain, we must insist on the procedures of image construction. This is the main subject of this first paper: to explain how a virtual archaeological model can be built, and how this process of model building is, in fact, a reasoning mechanism of explanation. We think by building images instead of writing texts.*<sup>11</sup>

Since archaeology is the only academic discipline that deliberately destroys its subject, more precise documentation is required. The techniques of computer aided photogrammetry, laser scanning, etc. also form a firm base for reconstruction illustrations in general, but usually the lengthy publications ultimately lack adequate illustrations that could eliminate the need for hundreds of pages of text. In the worst cases, the site is destroyed and reports remain unpublished. In the case of San Clemente, this was fortunately not so, even though the published material had to be supplemented on site.

The concept “Virtual Archaeology” was first proposed by Paul Reilly in 1990. Reilly described virtual archaeology as basically a set of computer techniques. The computer technologies (CAD, etc.) allow 3D visualization and realistic virtual representation of buildings (or objects in general) whose remains are gone or are in a poor state of preservation and difficult or impossible interpret<sup>12</sup>. This ongoing discussion since the 1990s has also highlighted well founded concerns on the reliability of reconstruction illustrations and virtual archaeology’s trustworthiness. The fast growth of 3D-technology in the entertainment business muddies the separation line between the entertainment and scholarly work based on academic arguments. To tackle this problem, Hugh Denard, Franco Niccolucci and Richard Beacham launched in 2006 the ongoing process of *The London Charter* which runs parallel to a similar process, *The Seville Charter*.

The current version of *The London Charter 2.1* (February 2009) has been adopted as an official guideline by the Italian Ministry of Culture. This comes from a need to reconcile heritage visualization with professional norms of research, particularly the standards of argument and evidence and the outputs should be held accountable. According to the charter, authors are expected, at a minimum, to situate their questions and arguments in relation to prior scholarship. Because in the visualizations, some subjects and arguments do not lend themselves to verbal expression, the argument as visualization should be presented in sequences since the finished image does not reveal its creation process. As

<sup>11</sup> Barceló *et al.* 2000a, 3-9; Barceló *et al.* 2000b, 9-37.

<sup>12</sup> Reilly 1991, 133-139.

the charter states, the visualizations: *should accurately convey to users the status of the knowledge that they represent, such as distinctions between evidence and hypothesis, and between different levels of probability.*” The Charter forms the basis of an EU MINERVA workgroup on standards for the use of 3D technologies in capturing and representing cultural heritage.<sup>13</sup>

The objectives of the charter are clearly stated. The aim is to provide a benchmark for having a widespread recognition among its stakeholders and also to promote intellectual and technical rigor in digital heritage visualization. To ensure that computer-based visualization processes and outcomes can be properly understood and evaluated by their users and to enable computer-based visualization to authoritatively contribute to the study, interpretation and management of cultural heritage assets. Great importance is put on access and sustainability strategies are determined and applied and to offer a robust foundation upon which the communities of practice can build detailed *London Charter Implementation Guidelines*.

*The London Charter* consists of a set of principles (Principles 1-6) which are *Implementation, Aims and Methods, Research Sources, Documentation, Sustainability and Access*. *Implementation* of the charter states that the principles of the London Charter are valid wherever computer-based visualization is applied to research or dissemination of cultural heritage. *Aims and Methods* state that a computer-based visualization method should normally be used only when it is the most appropriate available method for that purpose. Principle 3, *Research Sources*, states that to ensure the intellectual integrity of computer-based visualization methods and outcomes, relevant research sources should be identified and evaluated in a structured and documented way<sup>14</sup>.

Principle 4 (*Documentation*) is the most comprehensive of the its principles. This principle concerns the documentation and dissemination of the process’s methods and outcomes, and their understanding and evaluation in a context. This Principle is central to this dissertation and it is divided into 12 sub-sections:

#### *Enhancing Practice*

*4.1 Documentation strategies should be designed and resourced in such a way that they actively enhance the visualization activity by encouraging, and helping to structure, thoughtful practice.*

*4.2 Documentation strategies should be designed to enable rigorous, comparative analysis and evaluation of computer-based visualizations, and to facilitate the recognition and addressing of issues that visualization activities reveal.*

<sup>13</sup> Denard 2012, 57-71.

<sup>14</sup> *The London Charter*, version 2.1. (7.2.2009) at <http://www.londoncharter.org>.

*4.3 Documentation strategies may assist in the management of Intellectual Property Rights or privileged information.*

#### *Documentation of Knowledge Claims*

*4.4 It should be made clear to users what a computer-based visualization seeks to represent, for example the existing state, an evidence-based restoration or an hypothetical reconstruction of a cultural heritage object or site, and the extent and nature of any factual uncertainty.*

#### *Documentation of Research Sources*

*4.5 A complete list of research sources used and their provenance should be disseminated.*

#### *Documentation of Process (Paradata)*

*4.6 Documentation of the evaluative, analytical, deductive, interpretative and creative decisions made in the course of computer-based visualization should be disseminated in such a way that the relationship between research sources, implicit knowledge, explicit reasoning, and visualization-based outcomes can be understood.*

#### *Documentation of Methods*

*4.7 The rationale for choosing a computer-based visualization method, and for rejecting other methods, should be documented and disseminated to allow the activity's methodology to be evaluated and to inform subsequent activities.*

*4.8 A description of the visualization methods should be disseminated if these are not likely to be widely understood within relevant communities of practice.*

*4.9 Where computer-based visualization methods are used in interdisciplinary contexts that lack a common set of understandings about the nature of research questions, methods and outcomes, project documentation should be undertaken in such a way that it assists in articulating such implicit knowledge and in identifying the different lexica of participating members from diverse subject communities.*

#### *Documentation of Dependency Relationships*

*4.10 Computer-based visualization outcomes should be disseminated in such a way that the nature and importance of significant, hypothetical dependency relationships between elements can be clearly identified by users and the reasoning underlying such hypotheses understood.*

#### *Documentation Formats and Standards*

*4.11 Documentation should be disseminated using the most effective available media, including graphical, textual, video, audio, numerical or combinations of the above.*

*4.12 Documentation should be disseminated sustainably with reference to relevant standards and ontologies according to best practice in relevant communities of practice and in such a way that facilitates its inclusion in relevant citation indexes.*

Principle 5, *Sustainability*, urges planning and implementation of long-term sustainability

of visualization outcomes and documentation in order to avoid loss of this part's cultural heritage. Principle 6, *Access*, encourages wide access to this cultural heritage.

Even though the Principles concern visual archaeology mostly in its 3D form, I think that they are also applicable to the 2D-form. This dissertation's aim is to be among the most comprehensive implementations of *The London Charter*. It maintains that the augmented process of image construction is a scientific process in itself. The image so produced is a hypothesis in itself, resting on meticulous documentation.

### *Typology as a method*

Typology in statistics is a composite measure. Statistical typology involves the classification of observations in terms of their attributes on multiple variables. Typology is used in several fields, such as anthropology, archaeology, linguistics, psychology, theology, sociopolitics, etc.

In architecture and urban planning, several different typologies are used of which one of the most famous is Christopher Alexander's *Pattern Language* for structured design approach in urban planning. Alexander developed the *Pattern Language* as a design language of its own with its own vocabulary, syntax and grammar.<sup>15</sup>

In the most common building typology, the buildings are classified, for example, as agricultural, commercial, residential, educational, government, industrial, military, parking structures, storage, religious, transport, etc. The subject of this dissertation belongs to religious buildings, which would be divided into synagogues, churches, temples, etc. As San Clemente is a church, the subcategory would be basilicas, hall churches, etc. The aim of this particular typology would be to classify the Roman basilicas.

The typology created for this dissertation belongs to the group of architectural typologies. The earliest surviving architectural typologies go back to Vitruvius' *De Architectura*. In architecture, typology was already used at the time of the enlightenment. The modern need for separate buildings for separate functions demanded a classification system for the built environment<sup>16</sup>. Since the typologies between archaeology and architecture (of which the latter is also a subject for the former) are overlapping, the theoretical base for this dissertation comes from archaeology, especially when it comes to function as an attribute. Of the various types of typology mentioned above, an early exemplar of "functional classification" was discussed by A.D. Krieger who believed that artifacts should be classified to reflect their function and meaning to the peoples who had made and used them.<sup>17</sup> As in all fields, archaeological typology can be divided into several sub-categories, such as descriptive typology, chronological typology, functional typology, stylistic typology, etc<sup>18</sup>.

The method of this study is to use typology as means of studying the development of the basilica up to the fifth century. The definition of typology is recorded by Clifford Geertz

<sup>15</sup> Alexander 1977.

<sup>16</sup> Durand 1799; Durand 1800.

<sup>17</sup> Krieger 1944, 271-288.

<sup>18</sup> Hill and Evans 1972; Clarke 2014; Whallon and Brown 1982; Adams and Adams 1991.

in his famous definition of religion:

*Definition of typology*

*A typology is a conceptual system made by partitioning a specified field of entities into a comprehensive set of mutually exclusive types, according to a set of common criteria dictated by the purpose of the typologist. Within any typology, each type is a category created by the typologist, into which he can place discrete entities having specific identifying characteristics, to distinguish them from entities having other characteristics, to distinguish them from entities having other characteristics, in a way that is meaningful to the purpose of the typology.<sup>19</sup>*

For my method, I follow the guidelines established by William Y. Adams and Ernest W. Adams in their *Archaeological Typology and Practical Reality – A Dialectical Approach to Artefact Classification and Sorting*. The purpose of my typology of the Roman basilicas in this case belongs to the most common group of purposes according to Adams & Adams – the multiple purpose group. The purpose is, on the one hand, a comparative one when I study the differences in the basilicas at a specific time. On the other hand, the purpose is a historical one when I study the development and change over time and space. These two purposes are grouped into “Basic Purposes” according to Adams & Adams. The third important group is Instrumental Purposes. In this case, the instrumental purposes exist to illustrate the functional and physical development of the basilica as a building type in Rome through a survey of written and archaeological evidence on how the early 5th century Christian basilica was born from its secular predecessors and developed an ecclesiastical function at San Clemente.

The invariants of the typology used in this study are Basilica, Rome and the given timespan. The variables of the typology follow the description of the basilica in the *Kleines Wörterbuch der frühchristlichen Kunst und Archäologie* by Heinrich Laag:

*Basilica (Greek βασιλική στοά “a regal reception hall”), was adopted by Christians as a meeting hall from a Roman building type mainly a market hall (with an apse for the emperors statue) and an audience hall. The plan was in most cases rectangular. There were three, five or more aisles (plus the nave). A common characteristic is the naves exceeding height due to the clerestory wall over the aisles. On the short side, most often in the East in the Holy Land in Christian cities, is an apse. This is for the cathedra by the altar. Often there is a transept by the apse or the aisles end to smaller apses. The basilica is often approached through an atrium or a rectangular narthex or both.<sup>20</sup>*

The variables, which also apply to the Christian basilica, thus are: the nave, the aisle, the apse, the transept. The attributes for each variable are (presented in Tables I and II):

1. Main entrance: from the short or long side, through a narthex or not.
2. The aisle: How many aisles? Are the aisles only on two sides or on several sides (surrounding the nave), or do they form an ambulatory?

To make the list of variables more comprehensive, I add the following variables:

<sup>19</sup> Adams and Adams 1991, 7.

<sup>20</sup> Laag 2001, 39-40. In this case, the emphases are on the Christian basilica.

3. The nave: Does the nave have an apse? Does the basilica have a transept?

4. Does the basilica have a *quadriporticus* preceding the entrance or not? This attribute becomes evident when discussing the peristyle of a Roman late antique *domus*.

In the first part of the typological survey I present the basilica as a building type in the city of Rome from about third century BC to the beginning of the fifth century AD. I concentrate on the building type's functions and physical appearances according to the archaeological and literary evidence. The archaeological evidence from the city of Rome is supplemented with some archaeological evidence from the rest of the Roman world in order to draw conclusions about the development over functional and physical terms in the course of the given time. However, the time span concerning San Clemente, which starts from late antiquity, has been supplemented with a look at the Republican basilicas in Rome, since literary sources from Late Antiquity are limited. I shall consider the basilica as a typology – a set of types where the common factor is the outlay of the plan, and then make divisions between the types, e.g., the Pompeian, or the Vitruvian or early Christian. The function or age is not included in the variables, because I present the typology without these factors in order to be able to compare San Clemente's layout to the other basilicas as a building type. Since several types existed in the Mediterranean world, a look at the rest of the Roman world will be useful. Although the variants in the basilica in the Roman world 300-500 would be interesting, it is not in the scope of this dissertation to create a taxonomy of thousands of Mediterranean basilicas. Table I is just a reminder that this building type was built all around the Roman world. A single example from the chosen period in Rome is not sufficient to make a type, but when there are "sisters and brothers" in the neighborhood, a typology is possible<sup>21</sup>.

*The late antique domus, from private to public*

In addition, I also present a short survey of the late antique *domus* in Rome and its supposed influence on the Roman late antique *Sakraltopographie*. The *domus*', as Table IV shows, influence has been studied, especially in Rome by Federico Guidobaldi and in more general terms by Kim Bowes and Julia Hillner. However, the comparative study among *domus*, *titulus* and basilica is in its early stages<sup>22</sup>. My contribution consists of Roman examples and literary sources in general in order to relate the early Christian Roman basilicas and the *domus*' architecture together, which also relates to my proposed Phase IVb (Chapter 1.1). This study will also include a short study of the *domus* in its urban environment.

I am not going to present a full catalogue of Roman late antique *domus*, but to take into consideration a sufficient number of them to at least make a topographical point of their relevance in distribution. The selection and criteria will be explained in Chapter 3. Along with the basilicas in general, previous studies have shown their dismay at the absence of a comprehensive corpus of the late antique *domus*. However, LTUR provides enough information for Rome. There are so many similar architectural features in the Roman

---

<sup>21</sup> Brandenburg 2004, 29-37. Brandenburg gives a brief history of the basilica as a building type in Rome.

<sup>22</sup> See Bowes 2008 and 2012; Cooper and Hillner 2007; Dieffenbach 2007; Guidobaldi 1989, 1999 and 2000, White Vol. I and II 1990.

*domus* and basilica and they have been mentioned casually since Richard Krautheimer.<sup>23</sup> A more comprehensive general study on this subject still remains unwritten and this dissertation is not such either. However, for the singular case of San Clemente this is such and is partly augmented with other comparative Roman evidence.

### *The current appearance of San Clemente*

The medieval church and canonry of San Clemente is located in the Colosseum valley in Rome, between the Caelian and Oppian hills. The topography no longer gives the impression of a valley because differences in height have long since been leveled. On the East-West axis, San Clemente is located more or less between the Colosseum and the Lateran and between the present Via Labicana and Via S. Giovanni in Laterano on the North-South axis. To the east, the site is bordered by Piazza S. Clemente and to the west by Via dei Normanni. On the north side of Via Labicana, the Parco Oppio rises several meters higher than the Via Labicana, and its terraces give a nice view over the site. Between San Clemente and the Colosseum, there are the half-excavated remains of the smaller amphitheater Ludus Magnus.

The surrounding urban structure is mainly a result of the diagonal Via S. Giovanni from 1587 that cut through the site of San Clemente to continue to the Lateran, and on the other hand, the grid plan of the 1873 Piano Regolatore, which allowed the Romans to fully build up the rest of the neighborhood during the great building boom of the 1870s. When slowly climbing up the once steeper Caelian hill, one comes to the Via SS. Quattro Coronati, which, after many changes and decay, is once again following its antique direction. On the top of the hill, there stands the SS. Quattro Coronati, the other important 12th century church with antique origins in the neighborhood.

The surrounding 19th century city structure houses many activities in the buildings. Most of the activity there is based on the endless streams of tourists that follow their guides from the Colosseum to the Lateran along the Via S. Giovanni, as it was originally intended to be in the 1580s. There are, however, still the hideaways of the Romans, the trattorias that jealously guard their position as the retreats of the locals by hiding themselves from tourists' eyes behind blinds and curtains.

The present impression of San Clemente is somehow confusing, as is the case with many old Roman churches. On the one hand, it has a light yellow High-Baroque façade with a bell tower, but on the other, the unplastered clerestory walls with hints of blocked windows direct one's mind to something older. As is the case with many medieval churches in Rome, San Clemente can be entered from many directions. One of the easier is to enter the Baroque portal along the Via S. Giovanni, but the more impressive one, with the sense of a journey, is to enter through the medieval gatehouse. One has to take the steps down from Piazza San Clemente and then more steps higher up, through the prothyron with beautiful antique *spolia*. After going through the rib-vaulted, gatehouse one enters the atrium which is lined on two sides with a portico with *spolia*, and the main façade, the remodeled High-Baroque narthex. The Irish Dominicans have decorated the atrium (*quadriporticus*) with a small fountain and some palm trees. On the right hand side, one can see the plastered brick convent. When entering through the intimate atrium,

<sup>23</sup> There is no full research or study yet of the connection between the *domus* and the basilica in Rome.

through the vaulted narthex to the main nave of the basilica, one should not just step directly into the main nave - as hasty tourists often do - but first make a small excursion to the aisles of the basilica. There are the several artworks executed during the many centuries since the basilica was constructed in the first decades of the 12th century. On the left hand side, there is the 15th century Chapel of St. Catherine of Alexandria with the impressive frescoes by Masolino, and the 17th century Rosary Chapel. There are also several smaller monuments and inscriptions. On the right hand side, there are the chapels St. Cyril and Methodius and St. John the Baptist. Beautiful Cosmatesque floors cover the whole basilica, and in the middle of the nave there is the 6th century *schola cantorum*, the worth of which was also appreciated during the 12th century, as it was salvaged from the lower basilica that still exists below the present basilica. The most impressive focal point is naturally the great mosaic of the apse in green, blue and gold from the 12th century. This mosaic is in itself a testimony to the aims of the Gregorian Reform that tried to renew the Church. The complicated acanthus scroll motif includes between its leaves all flora and fauna and instructs the viewers of their place in the new world order created by Gregory VII.

The present appearance of the nave and aisles is the result of a renovation done by Carlo Stefano Fontana in the first decades of the 18th century. The heavy wooden coffered ceiling with gold trimmings and large paintings still goes well with the more playful “borrominesque” plaster pilasters. The end result is an *antipasto misto alla romana* – as always in Rome.

From the north aisle, one can enter the museum shop where for a modest price one can buy a ticket to the lower archaeologically excavated levels of San Clemente to first see the 5th century basilica just below the present one, with its impressive ninth century murals. The lower basilica is very similar to the upper one, lying approximately four meters above. The crucial difference is that the lower basilica is wider but otherwise the upper follows the same design. After studying the archaeological remains of the lower basilica, excavated from the 1850’s onwards, one can take the stairs down from the south aisle of the lower basilica to the first century storage building and *domus*, which has one of the most important Mithraic cult shrines in Rome in the original summer dining room of the domus. The site is truly a vertical time machine of some 2000 years of Roman history.

Since the building phases of San Clemente are extremely complicated and interwoven to say the least, it is important to present the full building history. The overlapping structures from different millennia give some direction and evidence. One has to remember that the present medieval church walls are partly from antiquity. This importance of also presenting more modern structures in this dissertation applies especially to the accurate maps by Giovanni Battista Nolli from 1748 and their value for recreating the urban structure of late antique San Clemente.

I have had to make some decisions about the terminology that are best explained here. Since this dissertation deals with both *domus* and *basilica*, I have decided to use the word *quadriporticus* when speaking about the *atrium* preceding a church. The words *peristyle* and *atrium* are always and only used in relation to a *domus*. When speaking about a *domus*, the word always refers to a single unit residential building (even when having public functions). The term “urban villa” is misleading when used in connection with a



large *domus* within the Aurelian Wall, which could not have had an agricultural function<sup>24</sup>. The Romans would not have considered a large *domus* on the Pincian hill a *villa*. The word reflects more 19th century North European preferences for suburban living than the function of the archaeological remains under consideration. The word “church” applies to any kind of a building that is solely for Christian worship. The names of the churches will be according to Krautheimer’s *Corpus Basilicarum Christianorum Romae*, i.e., mostly in Italian except the most well known such as the Lateran basilica or St. Peter’s.

In this dissertation, *reconstruction* means a hypothesis as in *virtual archaeology* or *architecture* and not a physical, manmade reconstruction. This reconstruction is based on archaeological remains, literary evidence and comparative material.

---

<sup>24</sup> Viitanen 2010, 5.



Fig. 0.01. The San Clemente gatehouse seen from the Piazza San Clemente.



Fig. 0.02. San Clemente's façade designed by Carlo Stefano Fontana (1713-19).



Fig. 0.03. The nave and the remodeled *schola cantorum* which originally dates from the first half of 6th century.



Fig. 0.04. The apse mosaic.



Fig. 0.05. The scale model (1/10) of the 6th to 8th century Baouit monastery basilica in Egypt built by Jean-Claude Golvin and Denis Delpalillo in the Louvre.



Fig. 0.06. The scale model (1/10) of the 6th to 8th century Baouit monastery basilica in Egypt built by Jean-Claude Golvin and Denis Delpalillo in the Louvre.



Fig. 0.07. The actual architectural detailing (capitals, paintings, etc.) displayed to scale 1:1 in the Louvre.

# 1 San Clemente in Rome

In this chapter, I deal with the various building phases of San Clemente according to the written and archaeological sources. The overview includes a building history of the site and its surroundings up to the present.

I provide a full description of San Clemente's building history. This is because when one wants to study a certain building phase of such a complicated structure that formed over 2000 years, one has to build a picture, not just of the remains of the early Christian phase, but of the remains preceding and following the subject phase. Since this is also an inquiry into a specific building history and one of its phases, architectural history traditionally demands the full history (in this case 2000 years) to put the specific phase in a wider context.

The description is followed by a three dimensional reconstruction based on the archaeological, comparative and written evidence (Chapter 4). I also examine the surroundings to place San Clemente in its urban setting. This is an important part of the study since the immediate (in this case 1/8km<sup>2</sup>) neighborhood explains some of its function. The reconstruction is partly based on measurements I took between October 2003 and March 2004 and rechecked in 2009-2010.

I also present a new hypothetical building Phase IVb that would precede the basilica and will be discussed in more detail in Chapter 3. In Phase IVb, I study more closely the relation between the Roman basilica and the *domus* and how *domus*' architecture might have influenced the design of basilicas in the 5th century.

## 1.1 Previous research

The Irish Dominicans who have held San Clemente since 1677, began the first excavations in the mid-19th century (Fig. 1.1.01 for Lanciani's view on the situation in 1901). The excavations were started by Father Joseph Mullooly O.P. in November 1857, and his campaigns revealed the lower church and the Mithraeum. Mullooly published his results in 1869 in *Saint Clement Pope and Martyr and his Basilica in Rome* (a revised edition was published in 1873). The next campaign was in 1908 when Father L. Nolan O.P. constructed a drainage tunnel to remove the water which had filled the lowest levels. He published the book *The Basilica of S. Clemente in Rome* in 1910 (later editions in 1914, 1925 and 1934). Other minor studies on the subject were made by Rudolph Eitelberger von Eitelberg (1863). During the same time, G.B. de Rossi published several works concerning the epigraphical material of San Clemente. G.B. de Rossi was one of the most important scholars studying the relevant written sources.<sup>25</sup> In 1896, M.F. Cumont published articles on the Mithraic cult at San Clemente.<sup>26</sup> Between 1900 and 1907, J. Gordin Gray published a series of articles in the *Journal of the British and American Architectural Society in Rome* under the name *The House and Basilica of S. Clemente on the Celian*. During the 1930s Richard Krautheimer studied San Clemente for his *Corpus*.

Krautheimer published a set of reconstruction drawings in the *Corpus Basilicarum Christianarum Romae* (all the early Christian basilicas in Rome) consisting of five published volumes between 1937 and 1980. Krautheimer was one of the most important figures in the field of early Christian basilica.<sup>27</sup> The other great scholar of the 1930's was E. Junyent who published the books *La primitiva basilica di S. Clemente e le costruzioni antiche circostanti* (1928), *Il titolo di S. Clemente* (1932), *Els primitius origins I desenrotllament de Titol de Sant Clement de Roma* (1929), *La basilica superior del Titol de Sant Clement de Roma I les seves reformes successives* (1930) and *Nuove indagini sotto la basilica primitiva di S. Clemente* (1938). Krautheimer and Junyent were the main authorities before Federico Guidobaldi. However, their views on San Clemente varied because Junyent believed that it would be impossible to form a coherent picture of the early Christian basilica – which was later on disproved by Krautheimer (Fig. 1.1.02. and 1.1.03.). In 1933, G. Gatti published *Titulus Clementis*. The fourth archaeological campaign was organized by J.P. O'Daly O.P. between 1936 and 1939.

Until the 1980s, not much happened at San Clemente but a small excavation in 1954 and the start of the restoration work (1963-1971). In 1962 A.M. Colini published his *Ludus Magnus* which is still the most complete archaeological review of the neighborhood of San Clemente. The complete description of the excavations of the *Ludus Magnus* also touched on the subject of San Clemente and the history of its surroundings from Republican times on<sup>28</sup>.

---

<sup>25</sup> De Rossi's works are "Scoperta di un insigne speleo mitriaco sotto l'antica basilica di S. Clemente" (1870), "I monumenti scoperti sotto la basilica di S. Clemente studiati nella loro successione stratigrafica e cronologica" (1870), "Le pitture scoperte in S. Clemente" (1863), "Del sepolcro di S. Cirillo nella basilica di S. Clemente" (1863) and "Roma, basilica di S. Clemente" (1865).

<sup>26</sup> Cumont 1915.

<sup>27</sup> Other important works in the field were *Early Christian and Byzantine Architecture* (1986) and *Rome. Profile of a City: 312-1308* (1980).

<sup>28</sup> Some minor articles were published before the 1980s by J.P. Kotroman (1949) and M. Lawrence

Father Leonard Boyle O.P., a learned medievalist, composed *A Short Guide to San Clemente in Rome* (1962, revised edition 1989), still in print and translated into six different languages, replacing R.M. Dowdall's O.P. *A Short Guide to the Historical Monuments in S. Clement's, Rome* (1950). He also wrote a monograph, *The Community of SS. Sisto e Clemente in Rome 1677-1977* (1977), and two articles, *The Site of the Tomb of St. Cyril in the Lower Basilica of S. Clemente, Rome* (1988) and *The Fate of the Remains of St. Cyril* (1978).

The next comprehensive study up to date is by Federico Guidobaldi. He studied the already excavated sites and carried out several excavations between 1981 and 1990 and a new one between 1993 and 1995, thus finding the baptistery. Guidobaldi has published the following studies: *Il complesso archeologico di S. Clemente. Risultati degli Scavi piu recenti e riesame dei resti architettonici* (1978), *Gli Scavi di S. Clemente a Roma* (1983), *Scavi 1981-82 nell'area del Convento di S. Clemente (Roma. Archeologia nel Centro)* (1985) and *San Clemente, gli edifici Romani, la basilica paleocristiana e le fasi altomedievali* (1992, Fig. 1.1.04 and 1.1.05.). The last mentioned work is the most profound of all concerning the early Christian phase of San Clemente, and was published in 1997 as *Gli scavi del 1993-95 nella basilica di S. Clemente a Roma e la scoperta del battistero paleocristiano: nota preliminare*. In addition, Guidobaldi has published on other themes concerning this study, mainly on the subject of the *titular* churches of Rome.

The medieval phases were studied by Joan Barclay-Lloyd in her *The Medieval Church and Canonry of S. Clemente in Rome* (1989) which is still the only comprehensive study of San Clemente from the 12th century up to the 14th century. In the same year B.V. Cosentino published *L'atrio della basilica di S. Clemente*.<sup>29</sup> The most recent addition to studies on San Clemente has been added by Patrizio Pensabene in his monumental *Roma su Roma* (2015)<sup>30</sup>.

Even though San Clemente is a very widely covered subject in the academic field, there is still much to be studied. Leonard Boyle covered the history of the Dominican brotherhood but the art history of San Clemente is still to be written<sup>31</sup>.

---

(1976). In the series "Le chiese di Roma illustrate" C. Cecchelli published a small book *S. Clemente* in 1930 and later in 1951 in *Roma Nobilis*. In 1974 he published *Osservazioni sulla basilica inferiore di S. Clemente in Roma*. In the 1950's M.J. Vermaseren published *Corpus inscriptionum et monumentorum religionis mithriacae* (2 vol. 1956-60) and in 1950 *Het Mithraeum onder de Kerk van S. Clemente*.

<sup>29</sup> During the 1970's and 1980's J. Osborne published a series of articles: "The Christological Scenes in the nave of the lower church of San Clemente, Rome" (1982), "The portrait of pope Leo IV in S. Clemente, Rome: a re-examination of the so-called 'square nimbus' in medieval art" (1979), "Early medieval wall painting in the lower church of San Clemente, Rome: the Libertinus cycle and its date" (1982), "Early medieval painting in San Clemente, Rome: the Madonna and Child in the niche" (1981), "The 'Particular Judgement': an early medieval wall painting in the lower church of San Clemente, Rome" (1981) and "The painting of the Anastasis in the lower church of San Clemente, Rome: a re-examination of the evidence for the location of the tomb of St. Cyrill" (1981). Osborne also published a book *Early medieval wallpaintings in the lower church San Clemente, Rome* (1979 and 1984).

<sup>30</sup> Other articles on the subject of San Clemente are: Brownlow 1897; Brunengo and Berardinelli 1859-1862; Bunsen 1842; Cantarelli 1915; Duthilleul 1958; Gray 1900-1907; Gugliemi 1966; Hessel 1869; Lentz 1975; Nolan 1914; Roller 1873; Russo 1989; De Rossi 1863a and 1863b.

<sup>31</sup> Of the general studies on various subjects there are several works. On the *horrea*, Rickman 1975; Staccioli 1962. On the Gregorian Renaissance: Toubert 1976. On the Christianization of secular buildings: Vaes 1980.



My study will contribute to this earlier scholarship on San Clemente by presenting a new detailed reconstruction using comparative materials and independent measurements of the site. It will also present an updated synthesis of the *Stand der Lehre*. The work encompasses all known primary and secondary sources pertaining to San Clemente. With the use of extensive comparative material, it will situate San Clemente within its spatial, comparative, chronological and typological context. Its main contribution is the reconstruction as a virtual hypothesis of not only the development of its building chronology but equally its design in detail. Using both extant remains and comparative evidence it shows the hypothetical Roman early Christian basilical interior and its relation to the Late Antique *domus* and its decoration. Using the common architectural concept of flowing space in both domestic buildings and Roman churches, this study explores their close relationship in spatial organization. This also includes a study of temporary means of separation, such as curtains in both the domestic and public spaces. This is supplemented by the close relation of decoration, such as *opus sectile* in both of the variants of space.

There is still much to be done in the scholarship on the *domus*' and the early Christian churches' relationship. Central to my dissertation concerning the relationship between the Roman early Christian basilica and the *titulus* is the previous work of J. P. Kirsch, Richard Krautheimer, Charles Pietri and Victor Saxer. In the matters of *tituli* concerning the possible meanings legally, topographically or otherwise, I have used mainly Federico Guidobaldi, Kim Bowes, Julia Hillner, L. Michael White, Ann Marie Yasin, L. Pani Ermini and Steffen Diefenbach. My work builds on these earlier studies and presents a new comprehensive analysis on the relationship between the Christian basilica and the *domus*. I have built a frame to support the reconstructions on this previous research.

The research literature on Vitruvius is vast. However, there is much less research on Vitruvius' influence on Late Antique architecture. Though it is impossible to know whether the builders or patrons of San Clemente were aware of Vitruvius, his works were definitely known at the time in Rome. Because San Clemente is one of these basilicas that closely follow the Vitruvian proportions, research on Vitruvius is vital. There is no disagreement that *De Architectura* was known in the 5th century since people like Sidonius Apollinaris mention him. The proportions of a Vitruvian basilica (Chapter 2.3) would correlate better with the early Christian basilicas than with those in Vitruvius' own lifetime. In my opinion, this could be proof of *writing architecture's* influence on Late Antique building since Vitruvian basilical proportions are only fulfilled in the fourth century.<sup>32</sup>

In general, the study of early Christian architecture has further developed since Richard Krautheimer's work. However, Krautheimer still remains in most cases the founding father of studies in Roman early Christian architecture. Hugo Brandenburg and Patrizio Pensabene have published large volumes of Roman early Christian architecture to supplement Krautheimer's work. One of the key changes in the studies has been a general agreement that there was no Christian architecture in Rome as such before Constantine.

---

<sup>32</sup> On Vitruvius and proportions in the 5th and 6th centuries: Plommer 1973; Krufft 1988; Petrovic 1962. *Writing architecture* in architectural research means theoretical writing on architecture instead of physically building it.

Moreover, the term *titulus*, which was earlier generally agreed as more fixed as a physical construction, has produced multiple and ever more complicated studies on legal and architectural terminology. The earlier consensus on early *tituli* was first challenged by Charles Pietri.

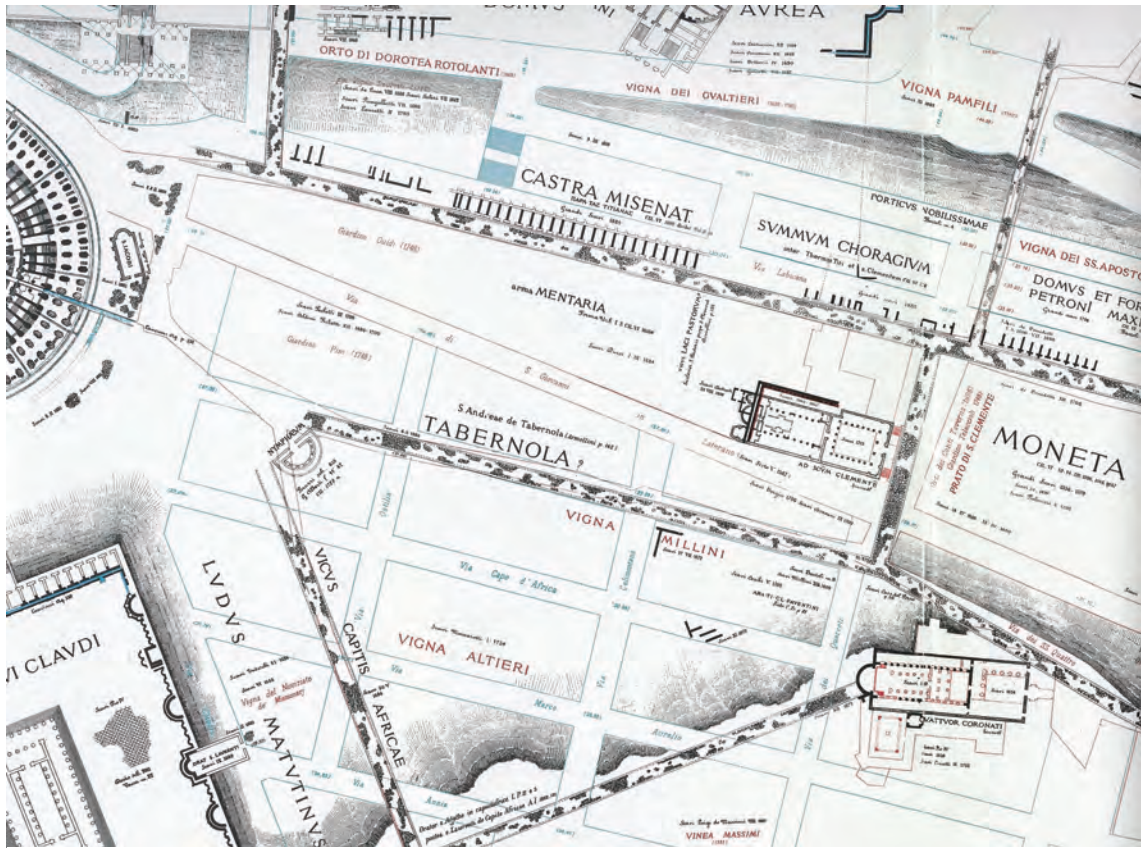


Fig. 1.1.01. Lanciani's Forma Urbis Romae and San Clemente (1901).

### 3. FAÇADE REMAINS AND RECONSTRUCTION

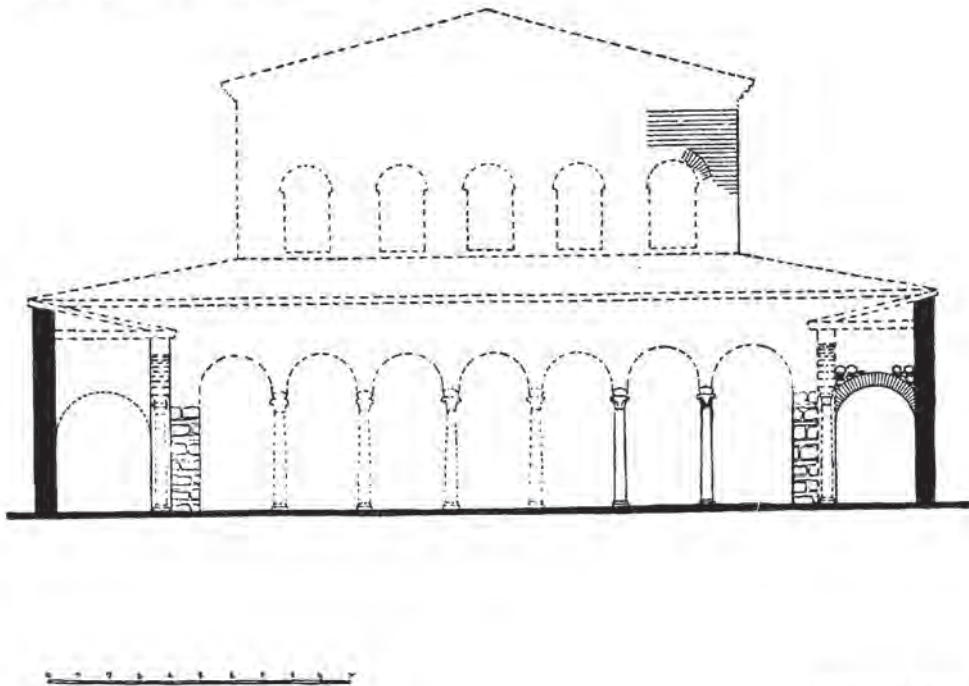


Fig. 1.1.02. Richard Krautheimer's façade reconstruction from CBCR.

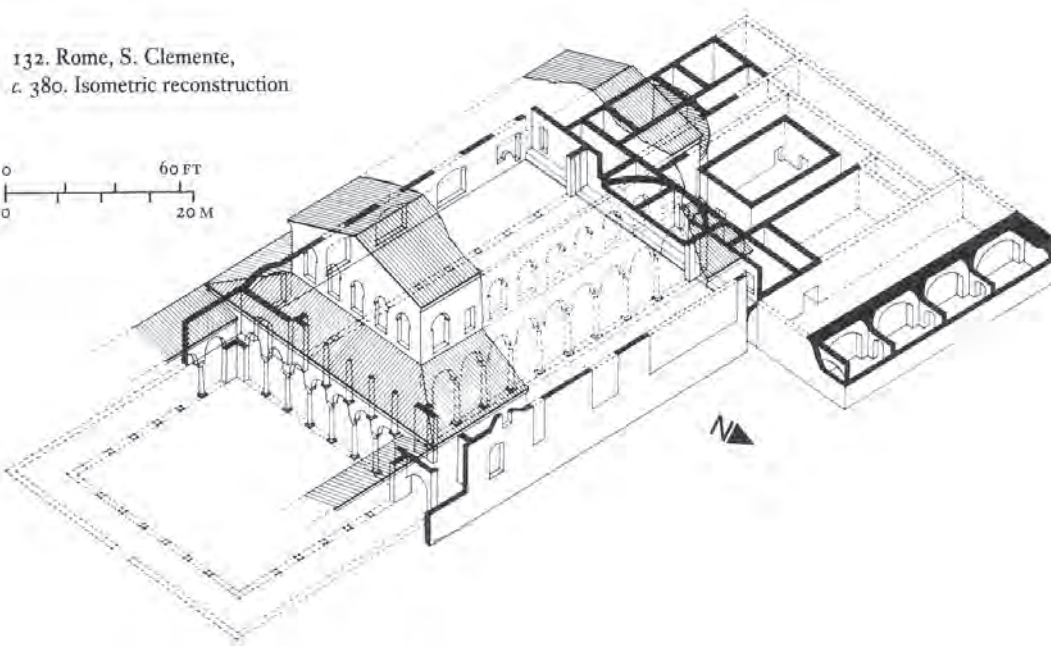
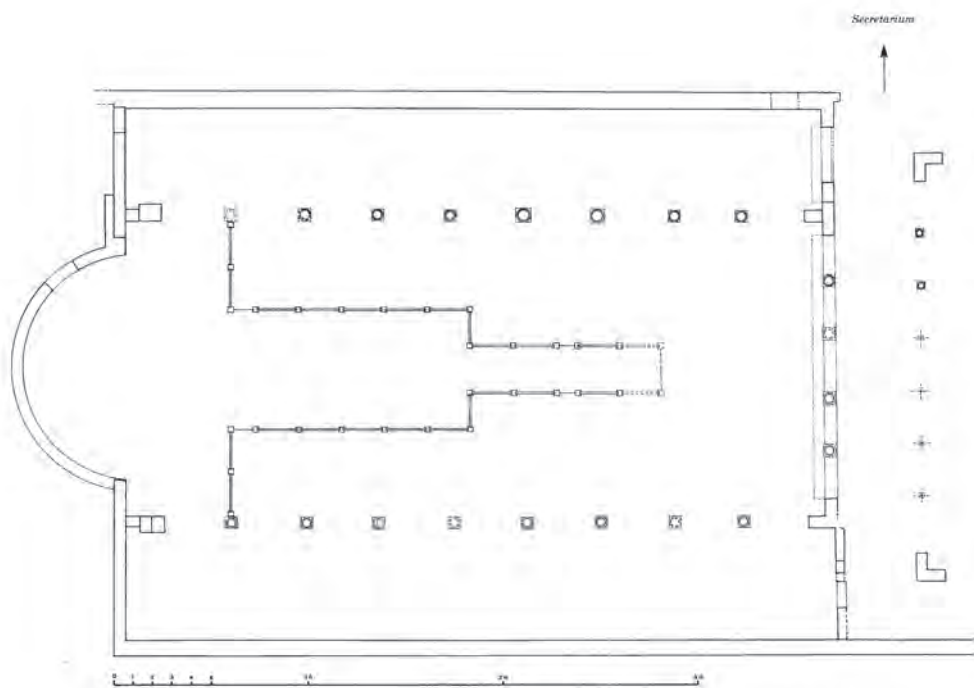


Fig. 1.1.03. Richard Krautheimer's isometric cut-through reconstruction of San Clemente in *Early Christian and Byzantine Architecture* (1986). The reconstruction of the *polifora/narthex* does not show the middle arch as larger than the others.



Tav. XVIII Basilica paleocristiana di S. Clemente. Ricostruzione della fase originaria con l'aggiunta della recinzione presbiteriale del VI secolo (ril. F. Guidobaldi, dis. R. Alessandrini).

Fig. 1.1.04. Federico Guidobaldi's reconstruction plan with the later *schola cantorum* in Guidobaldi 1992, Tav. XVIII.

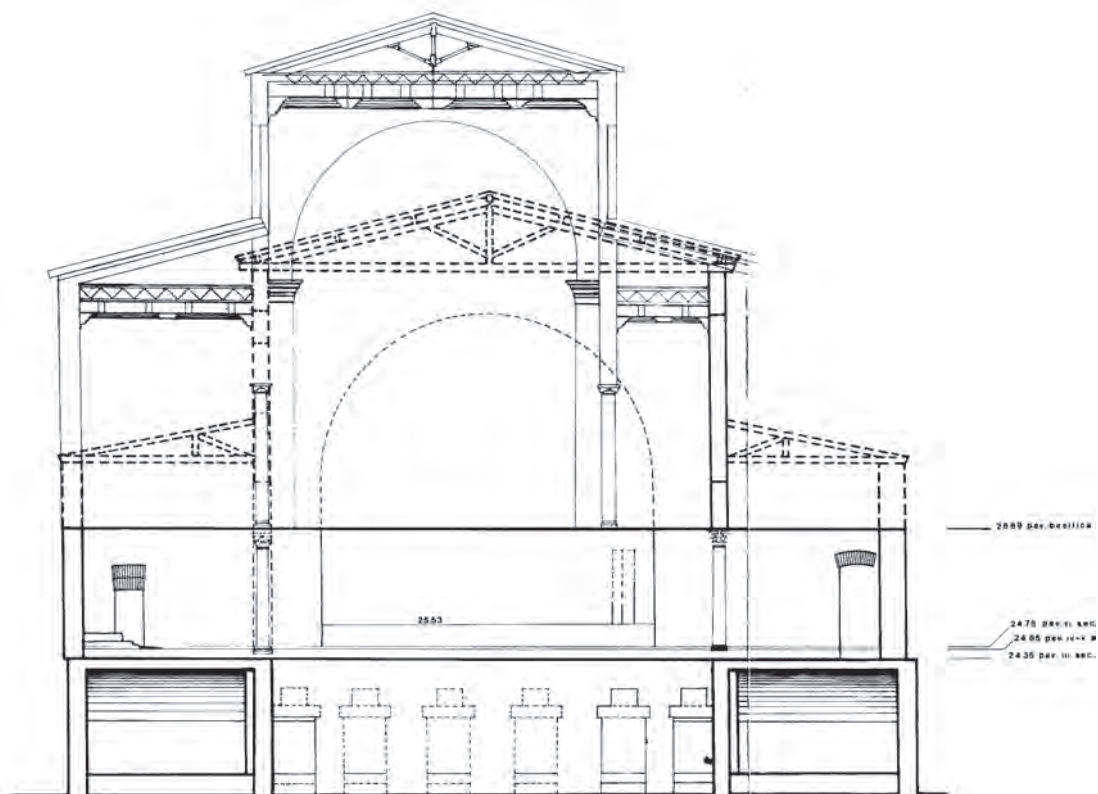


Fig. 1.1.05. Federico Guidobaldi's reconstruction section with the upper and lower basilicas in Guidobaldi 1992, Tav. XVII.

## 1.2 The site, its building history and urban context

The various building phases of San Clemente and its site are as complicated and interwoven as one might expect in a city like Rome. The stratigraphy of its building periods can, however, be divided into roughly twenty phases. My presentation of the sequence of building phases builds upon the works of Federico Guidobaldi and Joan Barclay-Lloyd with additions from Edouard Junyent, C. & M. Cecchelli and Patrizio Pensabene.<sup>33</sup> but each phase has been independently discussed and verified. My sequence equally makes new assumptions and adds a new building phase, Phase IVb.

For reconstructing Phase V (the basilica), it is vital to study Phases I-IV and the succeeding phases after Phase V since the site is not fully excavated and some hypothesis can also be drawn from the later building phases due to the typical Roman overlapping of structures. This also applies to the reconstructing of the urban structure and especially to the Renaissance building phases and urban improvements of Sixtus V. For the problematic building Phase IV, I have created an additional Phase IVb where Filippo Coarelli suggested a *Moneta* instead of a private building.

The Phases below are related to my illustrations.

### *Phase I*<sup>34</sup>

Of the earlier building phases of the surrounding neighborhood, there are few traces. During excavations on the site (Colini), traces of the Republican city were found. Originally the site of San Clemente was - and still is - in the lowest part of the Colosseum Valley, and there was a small stream that continued down to the site of the later Colosseum. Originally, the differences in the levels of the site were greater.<sup>35</sup> The street level was during Nero's reign about +17.50 – +18.50 (at present ca. +31.50). Before the Great Fire, habitation started to crawl up the Esquiline. One of the most famous of these *horti* was the gardens of Maecenas, which were left as a legacy to Augustus, in 8 BC, to serve as Imperial gardens for subsequent generations.<sup>36</sup>

After the fire of 64, Nero began the construction of his Domus Aurea where most of the surroundings were swallowed by large landscape gardens, and the central focal point was the small artificial lake, *stagnum*, on the site of the later Colosseum.

Under the *Mithraeum*, there are remains of a previous building phase. There are very few remains and they are dated to the time of the emperors Claudius or Nero. In Room AM there are visible traces of a wall.<sup>37</sup> The level of the floor is +18.45. The purpose of the building is very hard to determine. No traces of decoration have been found, but it might have been a domestic building.<sup>38</sup> On the North side of the *Mithraeum*, Rooms E1-E8 have no connection to the other rooms.

---

<sup>33</sup> Pensabene 2015, 208-216.

<sup>34</sup> For Phases I-IV, Guidobaldi 1992, 1, Tav. V is a major source. For all the phases and presentations, the labeling for the archaeological remains is the same as used by Guidobaldi.

<sup>35</sup> Colini 1962, 89.

<sup>36</sup> LTUR *Horti Maecantis*, Claridge 1998, 265.

<sup>37</sup> Guidobaldi 1992, 39.

<sup>38</sup> Guidobaldi 1992, 42.

## Phase II, Drawing XIV

During the reign of the Flavian emperors, the construction of the Domus Aurea was abandoned. The sons of Vespasian, Titus and Domitian, started to develop the site of the Colosseum from 70 (Fig. 1.2.07. and 1.2.08.). Vespasian abandoned the Domus Aurea in favor of the Gardens of Sallustius, and Domitian built the palace on the Palatine hill. The baths built for Nero were made public and were later known as the Baths of Titus. The original street grid was partly restored. The greatest project on the site was the Colosseum, which was built on the site of an artificial lake. On the east side of the Colosseum four training amphitheatres were built – the *Ludi Magnus* (nowadays visible on the site, Fig. 1.2.09.), *Matutinus*, *Dacicus* and *Gallicus*.<sup>39</sup> On the east side of the *Ludus Magnus* there was an *Armamentarium* (armory) built for the gladiators. The other great building projects associated with the Colosseum were the *Spoliarium*, *Sanitarium*, *Summum Choragium* and *Castra Misenatium*<sup>40</sup>. The *Sanitarium* was a certain kind of emergency hospital for the gladiators and the *Summum Choragium* was storage for the amphitheater's stage equipment<sup>41</sup>. The *Summum Choragium* cannot be placed exactly. In the Imperial period of the City of Rome, the neighborhood must have been a busy place since 93 of the official 153 holidays were for gladiatorial games.<sup>42</sup> The *Castra Misenatium* was for the sailors who were responsible for putting up the sun shades for the Colosseum.<sup>43</sup>

The Imperial Mint (*Moneta*) was also transferred to the site, possibly in the *horrea*.<sup>44</sup> An important source for the mint is the Marble Forma Urbis Romae (FUR, Pianta Marmorea or Forma Urbis Marmorea). Of this map, conceived during the years 203-211, 1186 small fragments are preserved, totaling ca. 10-15 % of the original map. One of the fragments carries a piece of a plan greatly similar to the remains of the *horrea* existing at San Clemente and bears the inscription *Moneta*.<sup>45</sup> However, the existence of the *Moneta* on the site of San Clemente has been strongly contested by Federico Guidobaldi based on both literary and archaeological evidence, especially for Phase IV.<sup>46</sup>

Phase II, associated with the rebuilding of the site after Nero's death, consists of two different buildings – the *horrea* (storage building) and a *domus*. According to the brick stamps, the *domus* was built between 90 and 96. These two buildings are located in a perfect line and they are separated by a narrow fire passage, C (0.67m), on their short sides (29.60m, 100 RF). The remains of the *domus* are the lowest level and parts of the first floor. The *horrea* remains consist of the ground floor because during the later campaigns the first floor was leveled.

The *horrea* probably had only one entry, with several storage rooms that open onto a central courtyard. The short side was 29.6 m long and the long side probably about 65 m (220RF).<sup>47</sup> The external building material is large tufa blocks (*opus quadratum*,

<sup>39</sup> Guidobaldi 1992, 1, Tav. II.

<sup>40</sup> LTUR I, Colosseum, Spoliarium, Sanitarium, Summum Choragium and Castra Misenatium.

<sup>41</sup> Colini 1962, 93.

<sup>42</sup> Mumford 1979, 268.

<sup>43</sup> Colini 1992, 94. LTUR I, Castra Misenatium.

<sup>44</sup> LTUR *Moneta* (Coarelli), Claridge 1998, 268-269.

<sup>45</sup> LTUR I s.v. Titulus Clementis.

<sup>46</sup> Guidobaldi 1992, 14.

<sup>47</sup> Guidobaldi 1992, 48.

1.05 m thick/5.5 RF). The storage rooms on the ground level were barrelvaulted and the separating walls in brick (*opus mixtum*) inside the *horrea's* outer rim of tufa outer walls. The rooms in the corners of the *horrea* were slightly larger than those directly facing the central court. The approximate measurements of the storage rooms on the longer sides were 4.30×5.6 m (Rooms A1-A10 and B1-B10, Fig. 1.2.01. and 1.2.02.), the corner rooms were ca. 3.70×7.90 m (rooms X, Y, Z and W) and the smaller rooms on the short side 4.10×2.30 m (C1-C4). On the longer sides were two staircases with adjoining corridors (AS1, AS2, AP on the A line and BS1, BS2, BP on the B line). The brick walls were ca. 0.42 thick). The floor level of the *horrea* was +19.60 m. The dating of the *horrea* is a difficult question. The building technique (a surrounding “envelope” of tufa and brick walls) justifies a hypothesis of the earlier version consisting only of the tufa walls (belonging to the Nero’s Domus Aurea’s landscape garden?). The vaulted fire alley separating the two buildings can be traced to the new fire regulations in Rome.<sup>48</sup> During the reign of Augustus, the height limit of buildings was lowered to 70 RF along public streets. Tacitus tells us that wood was prohibited in load bearing structures. Furthermore, every building had to have its own load bearing outer walls, which meant that neighboring buildings had to rest on their own walls.<sup>49</sup>

The function of the *horrea* is unclear. The theories are as follows: a barrack, the Imperial mint or *Moneta*, a storage building serving the Colosseum and its adjoining structures (e.g., *Ludi*, *Castra Misenatium* etc.) or a private storage building for letting out individual storage spaces to customers.<sup>50</sup> Of these, the imperial mint is almost impossible because, according to the written sources, the imperial mint remained on the same site until the fourth century and the lower church was already built at the end of the 4th century.<sup>51</sup> Since the rooms of the *horrea* are relatively small, minting with sledge hammers etc. is hard to imagine fitting in such a space without natural light unless it was done in the courtyard. The piece relating to *Moneta* in the Marble Plan has also vanished and is only known from drawings so it would be impossible to take the measurements and compare it to the archaeological evidence.

On the north side there are remains of an alley 3.70 m (12 ½ RF) wide<sup>52</sup>. There is a possibility that there was also a street on the south side<sup>53</sup> of the *horrea* since the whole area was rebuilt after Nero’s death, according to Tacitus. This new urban renewal must have followed a general plan. The use of exact measurements also points to some kind of predesigned urban renewal.

The remains of the *domus* are mainly of the lowest floor (later subterranean) barrel vaulted level. The wide stairs S (2.38 m) lead from the street level to a landing PS. The central feature of the *domus* is a barrel vaulted Room M (+20.75 m, 9.62 m×5.99 m, Fig. 1.2.03.) which may have acted as a summer dining room (cooler temperature during the hot Roman summers), as can be seen from the still extant stucco decoration. The later underground spaces for reception and enjoyment in Roman *domus* or villas are a

<sup>48</sup> Robinson 1992, 35.

<sup>49</sup> Suet. *Ner.* 16.1; Tac. *Ann.* 15.43.

<sup>50</sup> Guidobaldi 1992, 1, 59-61.

<sup>51</sup> Guidobaldi 1992, 1, 61-62 and Claridge 1998, 288.

<sup>52</sup> Guidobaldi 1992, Tav. V, XVI a) and XX.

<sup>53</sup> Guidobaldi 1992, 1, Tav. V, and 103-105.



common feature, as will also be described in Chapters 3.1. and 3.2. The very wide stairs leading to the level with the rich decoration would also point to the conclusion that this lowest floor was not meant for storage or other ordinary household tasks. The room is surrounded by a *cryptoporticus* (M, CS, CO, CN, CE ca. 2.00 m and continuing north CM 1.41 m, Fig. 1.2.04.), which was originally lit by clerestory windows opening onto the courtyard on top of the possible dining room. The *cryptoporticus* also leads to the “waiting room” AM (6.02×4.72 m, Fig. 1.2.05.) on the opposite side of the dining room. After Room AM, to the north there is a small entrance PM (2.02×4.72 m) to the fire alley. The last excavated Room is SM (5.96×4.79 m), later known as The Mithraic School. The second floor consists of rooms T1, T2 and T3 of a width of 4.85m each (Drawing VI). The floor level was +25.50 m. In these rooms there are traces of stairs leading up, which means that the *domus* has been at least three stories high. Rooms T1, T2 and T3 were later incorporated into the Lower Church.

### *Phase III*

At the end of the second, beginning of the third century, the floors of the *horrea* were raised by ca. 0.70 m using waterproof concrete.<sup>54</sup> Moisture had probably caused too many problems on the ground floor. Thus, the use of at least the ground floor as a granary is not plausible since the moisture from the ground would immediately have destroyed the stored grain.

At the same time, the *triclinium* of the *domus* was turned into a Mithraic shrine by closing the doorways to the *cryptoporticus*. The dining couches were remodeled for the religious services of the Mithraic cult. The decorations of Room SM (The Mithraic School) were also created. Most of the *Mithraeums* in Rome are built inside public buildings, as Coarelli points out.<sup>55</sup> However, there are also *Mithraeums* in domestic buildings, especially in Ostia.

The surroundings also saw several changes. On the north side of the present church water tanks (V1-V5) were built during Severan period (193-238). The remains of a building on the north side of the *horrea* are also from this time.<sup>56</sup> They have been identified by Guidobaldi as a second *domus*.

### *Phase IV*

The everyday life in the immediate surroundings continued as normal. The *ludi* were repaired several times and the gladiatorial shows continued.

While the *domus* with the Mithraic shrine was still in use, the first floor of the *horrea* was torn down and the ground level rooms were filled up with rubble, thus raising the floor level to +24.35 m. The function of the new building is still not known, and the remains of this phase are scarce. What we do know, according to Federico Guidobaldi, is that it had a rich decoration, having a central space surrounded by a narrower aisle on three sides. The remains of a rich *opus sectile* pavement point towards something more

---

<sup>54</sup> Guidobaldi 1992, 1, 274.

<sup>55</sup> Guidobaldi 1992, 1, 93.

<sup>56</sup> Guidobaldi 1992, 1, Tav. VII, and 248-249.

than just another factory or storage space<sup>57</sup>. New walls (MA on the south, MC on the west and MB on the north side) were raised on top of the tufa blocks of the ground floor of the *horrea*, and several large openings (MX1-MX3 and on the north side MZ) were created. The east aisle opened out, but we do not know whether there was a courtyard, as the area under the present atrium remains unexcavated.

According to the archaeological evidence, it is not clear if all MC ran through the whole length or not (Drawing VI).<sup>58</sup>

It would be tempting to speculate that the building of the third century was an early Christian gathering space, but the archaeological evidence yields absolutely no evidence of the function of the structure.<sup>59</sup> Federico Guidobaldi neither confirms or rejects the idea, but favors the idea of a domestic building.<sup>60</sup>

In my opinion, there would be some help from the limited Roman building typology, since the *domus* or residential buildings in general served a wider set of functions than in the modern world. This is a feature that is often overlooked in archaeology when determining functions.

#### *Phase IVb, Drawing XII*

My main amendment for this building chronology is this phase. As Federico Guidobaldi has pointed out, the remains of Phase IV are few but identifiable. I would suggest that during the course of several minor alterations finally the two separate structures were joined by the vaulting over the early imperial fire alley thus creating one large *domus*. The highly hypothetical reconstruction Drawing XII would place, as the whole construction's focal point, a peristyle that would become the *quadriporticus* in Phase V. First of all, acquiring neighboring properties (or pieces of them) to enlarge one's own was nothing new in the Roman world. This is evident in Herculaneum and Pompeii and was also done at San Clemente in the sixth century by appropriating the *domus* on the northern side to make the *secretarium* and the baptistery. This would also be reasonable (Table IV, Chapter 3.1 and 4.3) in the context of a Roman basilica built over or within a *domus*.

The vault spanning the 0.67 m alley was probably already built in the 1st century, thus making a physical connection between the two buildings (Fig. 1.2.06.)<sup>61</sup>. As shown on Map III, the building of larger *domus* was frequent during and after the Severan period. In a high density neighborhood such as the Colosseum Valley to build larger would also mean acquiring neighboring properties (as was done in Pompeii and Herculaneum earlier). However, the research on Roman real estate acquisition and legislation is relatively new and we do not have a clear picture of its processes.

Previous research has mainly concentrated on these two buildings as separate units with separate chronologies climaxing in the event of the demolition of the *domus* with the *Mithraeum* and converting the other into a church. However, I find it plausible to offer

---

<sup>57</sup> Guidobaldi 1992, 275.

<sup>58</sup> Guidobaldi 1992, 1, Tav. IV; Cecchelli 1974, 106, 119.

<sup>59</sup> Guidobaldi 1992, 276.

<sup>60</sup> Guidobaldi 1992, 114.

<sup>61</sup> Junyent 1932, 50-57. Guidobaldi 1992, 67.

this alternative preceding Phase IVb, which would by no means be rare in the Roman world.

However, nothing can be said of any Christian activity in this hypothetical Phase IVb (the “super-domus”) according to the archaeological evidence. The literary evidence to support this is in Chapter 1.3 and the comparative evidence in Chapter 3.3 and Table IV. This will be summarized in Chapter 4 along with the possible architectural relationship between early Christian Roman basilica and the Late Antique Roman *domus* with *polifora* and peristyles (as I have shown in Drawing XII). However, Phase IVb can only be verified by excavations or hopefully in future by more sophisticated survey technology. This said, based on the context of Roman churches and *domus*, this addition would be completely in lines with other developments in Rome and the archaeological data does not prove it to be impossible (Phase V, Drawing XV).<sup>62</sup>

#### *Phase V, Drawing VI and XII*

After Constantine, Rome was still the largest city in the world. During the reign of Constantine, there were approximately 800,000 inhabitants.<sup>63</sup> Property ownership was for the few and about a third of the area was covered by the most luxurious *domus* which housed about 3% of the population<sup>64</sup>. The nearby Colosseum Valley was an important traffic junction because several roads and streets crisscrossed there. The Christian population of Rome started to grow very rapidly. In the year 312, according to various estimates, one third of the total population may have been Christian or people sympathetic to the new religion. The other important cults of the time were the Mithraic cult, the Isis cult, the Magna Mater cult, the Syrian cults and Judaism. The oldest churches of the time were modest places of gathering and they were likely located in a *domus*. The old word for a Christian gathering place, *titulus*, comes from this very concept, but appears the first time at the end of the 5th century. The phrase probably simply indicated the owner of the house. The modest *tituli* must have been swallowed by the splendor of Rome –altogether ca. 44,000 *insulae* intermingling with still existing great temples and other public buildings.<sup>65</sup> The assumption that the third century building was a *titulus* that replaced a former, more modest building phase is partly based on the information we have about *Titulus Clementis*.<sup>66</sup> The first phase of SS. Quattro Coronati, the neighboring church, is also dated to this same period, when a reception hall of a large *domus* was transformed into a Christian gathering space.

The end of the 4th and beginning of the 5th century marked a period of busy church building. In H. Geertmans opinion, this was the period when the new *tituli* of *Anastasiae*, *Clementis*, *Crescentianae*, *Pudentis*, *Pammachi*, *Apostolorum* and *Vestinae* started to replace the more modest *domus ecclesiae* of the city.<sup>67</sup> However, the general agreement nowadays is that there was no distinctive Christian architecture before Constantine or at least, there is no archaeological evidence for it.

---

<sup>62</sup> For the Phase V, Guidobaldi 1992, 1, Tav. V.

<sup>63</sup> Krautheimer 1980, 7.

<sup>64</sup> White I 1990, 144.

<sup>65</sup> Krautheimer 1980, 14.

<sup>66</sup> Krautheimer 1980, 34.

<sup>67</sup> Geertman 1988, 82.

At the end of the fourth century, the collapse of the Roman Empire had begun. The first proper church of San Clemente was built on the site sometime between the last decades of the fourth century and the first of the fifth. The Ludus Magnus was still operating, but during the fourth century, gladiatorial games were prohibited and the small amphitheater was turned into a graveyard. The games were officially banned in 404 by Emperor Honorius.<sup>68</sup> It is highly likely that the street grid stayed the same. During the fifth century, wandering tribes around Europe began to attack Rome, and the political and governing center of the Mediterranean had already been moved to Constantinople. In 410 the Goths led by Alaric conquered and savaged Rome. The population sunk dramatically at that time, and habitation began to concentrate on the field of Mars and in Trastevere. The area between the Lateran and the Colosseum was mostly abandoned. In 410 the population of Rome was ca. 800,000, 500,000 after the sack of 452 and in the sixth century only ca. 100,000, very soon only 30,000, and for a short period only rose up to 90,000 due to refugees from the Longobard raiding in the surrounding countryside. The exact nature of the urban structure is unknown, but probably the large *insulae* were still in use, though slowly deteriorating.<sup>69</sup> The area between the Lateran and the Colosseum was later turned into fields and vineyards.<sup>70</sup>

The building of the Lower Church of San Clemente took place during this time (end of 4th or beginning of 5th century). The already existing walls of the third century were partly reused and the *domus* was partly demolished to accommodate the apse of the basilica.<sup>71</sup> The technique used in the building is very similar to that employed in S. Paolo fuori le Mura (384-403). The floor level was raised to +24.65. Rooms T1-T3 of the *domus* were incorporated as service rooms (vestry?) of the basilica, and the apse was constructed on top of the Mithraeum, leaving the basement level partly still in use<sup>72</sup>. The Mithraic cult became illegal in 392 along with other pagan cults<sup>73</sup>. The end result was simple: a basilica with a nave and two aisles and an apse. The nave was 36.00 m long, 15.50 m wide and 13.50 m high (50 RF×122 RF×45 RF). The width of the aisles was 5.30 m (18 RF, Fig. 1.2.10., 1.2.11. and 1.2.12.). The narthex was 4.40 m wide and 28.15 m long (15 RF×95 RF). The outer measurements were 100 RF×160 RF (the length includes the apse). The basilica was probably entered through an atrium or a *quadriporticus*<sup>74</sup>, which might have had the dimensions of the earlier *horrea*, thus being 240 RF in length. There has been general agreement on the quadriporticus since Junyent because piers LQ1 and LQ2 are L-shaped (Drawing VI). The columns were ca. 0.70 thick at the base, and the walls were ca. 0.90 m thick. The church was somewhat lower than the other basilicas from the same time. The still partly extent large “keyhole” windows measure ca. 2.10×3.25 m

<sup>68</sup> Mumford 1979, 272.

<sup>69</sup> Krautheimer 1980, 68; Wheeler 2001, 129.

<sup>70</sup> Barclay-Lloyd 1986, 115.

<sup>71</sup> Brandenburg (2004, 142-152) gives the most up to date short description of the early Christian and medieval phases of San Clemente.

<sup>72</sup> Guidobaldi 1992, 1, 276.

<sup>73</sup> *Cod. Theod.* 16.10.12: ... *Manque omnia loca quae thuris constiterit vapore fumasse, si tamen ea in iure fuisse thurificantium probabuntur, fisco nostro adsocianda censemus.*

<sup>74</sup> Art historians of this and later periods call this open court surrounded by colonnades an *atrium*. Since this study also concerns the *domus* (which has an *atrium* and *peristyle*), it might be misleading to use the traditional atrium. Henceforth, the *atrium* or *atria* of an early Christian basilica will be called a *quadriporticus*.

(7×11RF). The *narthex* was completely open to the outside without doors (*polifora*). The southern wall MA was still open to the street through the openings and also the wall MB had a doorway (Drawing VI). The staircase of the *domus* was also incorporated into the new basilica and it led to the previous Mithraeum which might now have been used as a crypt. The appearance of the building was thus very much like the other Roman early Christian basilicas, having the main aisle open to the outside and the *narthex* acting as the intermediate space between the *quadriporticus* (or whatever else might be outside) and the nave.

#### *Phase VI*

During the fifth or sixth centuries, a baptistery was added that was built on the northern side of the north aisle and incorporated within the already existing Severan building on the site (Fig. 1.2.14).<sup>75</sup> The basilica remained otherwise intact, except for some decorations, like the marble *schola cantorum* which was created 514-535 (Fig. 1.2.13.). The choir was built by Bishop Mercurius who later became Pope John II (533-535).<sup>76</sup> The floor level was also raised to +24.75. There is no evidence of previous liturgical furnishings.

#### *Phase VII*

Part of the painted decoration was done during the seventh century<sup>77</sup>. Part of the wall of the north aisle was also rebuilt, and some existing openings were blocked. According to the *Liber Pontificalis*, Hadrian I rebuilt the roof somewhere between 772 and 795.<sup>78</sup>

#### *Phase VIII*

Rome saw several building projects at this time due to the short bloom of building activity during the Carolingian Renaissance (775-950)<sup>79</sup>. In August 847, Rome suffered a serious earthquake. The resulting damage is also visible at San Clemente. The earthquake seriously damaged the load bearing clerestory walls and the *narthex*. Because of this, two of the arcades were buttressed with piers, and three of the *narthex* arcades were completely closed. Later the piers were decorated with paintings which still partly exist, and represent one of the best examples of painted decoration from that period.<sup>80</sup>

The relics of Saint Clement were transferred from the Black Sea area to San Clemente between 867 and 872. There were no relics of the saint before this time at San Clemente.<sup>81</sup>

#### *Phase IX*

The surrounding areas were probably completely empty during the 11<sup>th</sup> century, except for San Clemente and SS. Quattro Coronati. The political life of Rome was very turbulent,

<sup>75</sup> Guidobaldi 1997, 459-489. The new excavations from the 1990's and later are not discussed here in closer detail since the archaeological evidence mainly concerns building phases from the sixth century onwards. The important point is the evidence of an insula and a street to give us a picture of the surroundings at that time.

<sup>76</sup> CBCR I, 130; Guidobaldi 1992, 1, 277.

<sup>77</sup> Guidobaldi 1992, 1, 277.

<sup>78</sup> LP Hadrianus I: *Tectum vero tituli beati clementis quae iam casurum erat...a noviter restauravit...*

<sup>79</sup> Barclay-Lloyd 1986, 117.

<sup>80</sup> Barclay-Lloyd 1986, 118.

<sup>81</sup> Guidobaldi 1992, 1, 284-285.

and disagreements between the Vatican and European rulers culminated in the Norman campaign of 1084 led by Robert de Guiscard, when Rome was burned from the Lateran up to the field of Mars.<sup>82</sup> The next conquest was by Henry V in 1116 and the Colosseum was turned into a fortress, which was used by the popes and their allies. The battling Roman aristocracy divided Rome between them into zones, and the Colosseum area belonged to the Frangipani family<sup>83</sup>.

The Lateran and the Vatican were connected by an important road, Via Maior (Via SS. Quattro Coronati), that ran on an already existing Roman street and probably ran for a part of the way, up to San Clemente, under the present Via SS. Quattro Coronati. Benedictus Canonicus has described a papal procession (1130-1143) which left the Lateran and continued through an aqueduct arch, passed by San Clemente and turned left onto the present Via Labicana.

After the earthquakes and other calamities, San Clemente was in bad shape. It has been suggested that the sack of Rome by Robert Guiscard in 1084 probably precipitated the demolition of the church, but there are no traces of fire or other intentional destruction at San Clemente, unlike, for example, at SS. Quattro Coronati. The last reported event was the election of Pope Pasqual II on the fourteenth of August 1099. Ultimately, however, San Clemente was torn down.<sup>84</sup>

#### *Phase X,*<sup>85</sup> Drawing XVI

The rebuilding of San Clemente took place during the so-called Gregorian Reform. The new church was built some 4m above the earlier basilica. With the rebuilding of S. Maria in Trastevere, SS. Quattro Coronati and S. Maria in Cosmedin, the rebuilding of San Clemente constitutes deliberate proof of a return to early Christian architecture. The rich mosaics of these churches employed the same motifs as early Christian mosaics found, for example, in the Lateran baptistry, with rich acanthus scrolls. Spoils were enthusiastically collected from around the decaying city to decorate the fruits of the new building boom. During the 12th century, habitation started to slowly spread out from the Colosseum towards the Lateran, but the area was still hopelessly deserted, as Pope Paschal II notes in his bulla from 1116: *The land has turned into wasteland because the people have long gone...due to long wars.* The Pope planned to settle the abandoned lands by moving monks there. SS. Quattro Coronati was fortified to protect the inhabitants and to safeguard the papal procession road of Via Maior.<sup>86</sup>

During the same time, a small church or a chapel, S. Servulus, was built next to San Clemente. The little evidence we have for this building is on the early maps of Rome and in the writings of Fra Marino.<sup>87</sup> Another important building was the chapel of S. Pastore which also no longer exists.<sup>88</sup> A third one was the hospital of S. Giacomo, founded in 1223

<sup>82</sup> Krautheimer 1980, 149.

<sup>83</sup> Krautheimer 1980, 157.

<sup>84</sup> Barclay-Lloyd 1986, 118.

<sup>85</sup> For Phase X, see Barclay-Lloyd 1989, illustrations.

<sup>86</sup> Krautheimer 1980, 321.

<sup>87</sup> Barclay-Lloyd 1986, 123.

<sup>88</sup> Colini 1962, 108.

by Cardinal Giovanni Colonna. This hospital was demolished during the first decades of the 19th century.<sup>89</sup>

The rebuilding of San Clemente was started by Cardinal Anastasius around 1100. Some of the walls of Lower Church were left to be used for the new load bearing walls. The basilica was narrowed, so that the south walls used on the load bearing walls of the lower church. The new north aisle wall rests on the clerestory wall of the lower church. This meant that new foundations had to be laid for the new northern clerestory wall. Parts of the *secretarium* were used for the new monastic buildings. The *schola cantorum* was moved to the new basilica and assembled slightly differently. The *quadriporticus* was also rebuilt, but in a slightly narrower version. The length of the basilica was 71.00m from the apse to the gatehouse, and the width from aisle to aisle (the outer limits) was 22.80m. The exterior dimensions of the basilica were 42.00m from the apse to the external wall of the narthex, the interior width of the south aisle was 5.40m and that of the north aisle 3.40m. The clerestory had small arched windows. Small *oculi* were planned in the western end, but the idea was abandoned during construction. The new floor level was +28.89. There is some graphic evidence of the appearance of the new basilica from a wood cut by Fra Santi's from 1588.<sup>90</sup>

The later phases studied by Barclay-Lloyd are important to this dissertation, since the upper church incorporated much of the lower church into its structure, as can still be seen in the nave of the upper church.

For any reconstructions of an Early Christian Roman Basilica it is noteworthy that, starting from Santa Prassede in the 9th century and down to the Gregorian Reform, there is an obvious tendency to imitate the 5th century basilical architecture. In my opinion, it would be possible to use Roman 11th-12th century architecture to fill gaps in our knowledge of Roman Early Christian architecture.<sup>91</sup>

#### *Phase XI, Drawing XVI*

The general development was still moderate or slow at this time. Shortly after 1125, the gatehouse of San Clemente was built with a single story. Thus, the *quadriporticus* between the narthex and the gatehouse was created (Fig. 1.2.15.). There is still some uncertainty about the existence of proper colonnades on all four sides since the *quadriporticus* is not shown in the illustrations of the 17th and 18th centuries.<sup>92</sup> The chapel of San Servulus (the small building in Drawing XVI, the south-east corner) was finished and it had a bell tower of its own.<sup>93</sup> The monastery was enlarged. During this time, Cardinal Anastasius died and his successor Petrus took charge of the building project. The connection of the project to the Gregorian Reform is through Bishop Leo of Ostia, who wrote the history of the rebuilding of the monastery at Monte Cassino, and knew Cardinal Anastasius and

---

<sup>89</sup> Colini 1962, 108.

<sup>90</sup> Fra Santi, S. Clemente, view as in 1588, woodcut (Fra Santi, *Stazioni delle chiese di Roma . . .*, Venice), 1588, 36. O

<sup>91</sup> Caperna 1999. For a closer look at Santa Prassede. Panofsky 1972 in general on the subject of renaissances.

<sup>92</sup> Mabillon, plan 1689; Ciampini, plan 1690.

<sup>93</sup> Barclay-Lloyd 1986, 71.

Pope Paschal II.<sup>94</sup>

*Phase XII, Drawing XVII*

During the first half of the 13<sup>th</sup> century, the building activity was concentrated on the monastery. The southern wall of the medieval *quadriporticus (atrium)* was built. However, from this time there is finally precise evidence of the existence of the colonnade. A new wing was added (Wing C on the Barclay-Lloyd plans) and Wing A received a new floor. The campanile (torn down in the 17<sup>th</sup> century) was also rebuilt. There is evidence of it on several maps and illustrations.<sup>95</sup>

*Phase XIII*

In the second half of the 13<sup>th</sup> century, a new floor was added to Wing B, which was connected to the medieval *quadriporticus (atrium)* by a staircase. Later the present bursar's (earlier prior's) suite was added on top of it<sup>96</sup>.

*Phase XIV, Drawing XVIII*

During the 15<sup>th</sup> century, Wing A was connected to the basilica, thus forming with the earlier opposite staircase a small inner court (cloister, +32.34). This addition was embellished with a small loggia which opened onto the small courtyard. San Clemente appears during this time on the Strozzi map from 1474. The church was also included in the pilgrimage guide of John Capgrave from 1450 and N. Muffel's *Beschreibung der Stadt Rom* from 1452.

During the cardinalship of Branda di Castiglione (1411-1431), the Chapel of St. Catherine was built by closing part of the south aisle. The chapel was decorated with frescoes by Masolino da Panicale. These represent the martyrdom of St. Catherine of Alexandria.<sup>97</sup> The Chapel of St. John the Baptist was also built at this time.<sup>98</sup> A chapel had been designed previously, but for some reason, it had never been constructed.<sup>99</sup> In the year 1477, the burial monument of Cardinal Roverella was erected, probably by Andrea Bregno and Giovanni Dalmata.<sup>100</sup>

*Phase XV*

During the 16<sup>th</sup> century, Wing A was finally built up to the border of the present Via Labicana. Moreover, some new windows were built to replace the older smaller medieval windows. San Clemente appears on the following maps: Bufalini (1551), possibly Dosio (1562), Cartaro (1576) and Dupérac (1577) and in the publication by Fra Santi (1588, woodcut drawing, showing the façade) which gives a good view of the narthex façade.<sup>101</sup>

---

<sup>94</sup> Barclay-Lloyd 1986, 63-65.

<sup>95</sup> Fra Santi 1588, woodcut of San Clemente façade.

<sup>96</sup> Barclay-Lloyd 1986, plans.

<sup>97</sup> Boyle 1976, 37.

<sup>98</sup> Boyle 1976, 33.

<sup>99</sup> Guidobaldi 1992, 1, Tav. I.

<sup>100</sup> Boyle 1976, 33.

<sup>101</sup> In the following passages, I shall mention only briefly the maps where San Clemente is pictured. All of the maps listed with the year of first publication are from Frutaz 1962.



### *Phase XVI*

During the last decades of the 16th century, Rome faced the grandiose projects of Pope Sixtus V. The new Via S. Giovanni in Laterano cut the plot of San Clemente in half, necessitating the destruction of the chapel of S. Servulus and other, possibly domestic, buildings. The project was a part of a bigger plan to connect the major pilgrimage churches. Habitation quickly began to spread around this new street and the old vineyards gave way to these new urban structures. This completely changed the approach to San Clemente by placing the entrance along an important street designed for pilgrims. The clerestory windows were also changed into new rectangular ones. The San Clemente of this era appears on the map by Tempesta (1593) and in Ugonios *Historia delle Stationi di Roma* (1588).

### *Phase XVII, Drawing XIX*

In the year 1617, the Chapel of the Holy Rosary was built. The chapel is decorated with a painting by Sebastiano Conca. In the years 1628-1629, the old bell tower was torn down to be replaced by a new Baroque bell tower on the Via S. Giovanni side. The old bell tower was perhaps beyond repair or the new entrance from the Via S. Giovanni was intended to be highlighted by a new vertical theme. In the year 1621, the population of Rome was 120,000 and it steadily rose to 150,000 by 1709.<sup>102</sup>

San Clemente appears in the following publications: Ottavio Pancirioli's *Tesori nascosti dell'alma città di Roma* (1600), Fioravante Martinelli's *Roma ricercata nel suo sito* (1644), Greuter (1618), Maggi (1625), The Falda map (1676) and in the guidebooks by Ciampini (1690), Mellini (1667) and Rondini (1706). There are also some drawings to scale created for the renovation eventually carried out by Carlo Stefano Fontana. The Ciampini drawings show the original medieval interior before the Fontana renovation and the Falda map is probably the most accurate representation of the Colosseum Valley from the time before the famous Nolli map.

### *Phase XVIII, Drawing XX*

The best possible source for Rome's older urban structures is the Nolli map. Giovanni Battista Nolli was perhaps the most famous mapmaker of Rome during the 18th century. This map was very carefully measured showing the plans of the most important buildings with great accuracy. By the 1750s the Via S. Giovanni in Laterano was lined with small palaces and other buildings. On the map, these small palaces are depicted with attractive little formal gardens.

The large renovation designed by Carlo Stefano Fontana (1638-1714) was conceived during the pontificate of Pope Clemens XI (1700-1721). Fontana is the first architect known by name associated with San Clemente. Fontana was the most famous of the Roman late Baroque architects. He also designed the Palazzo di Montecitorio (1651-1694) and oversaw the rebuilding of SS. Apostoli in Rome.

The most important changes were made to the exterior, mainly the narthex, which was fully remodeled. The interior of the basilica was also completely remodeled in Baroque

<sup>102</sup> Hibbert 1985, 202.

fashion. This included the present ceiling, decorative work in plaster, and the new windows. Paintings by Giuseppe Chiari (1654-1729), Sebastiano Conca (1676-1764) and Giovanni Odazzi (1663-1731) were added.<sup>103</sup>

San Clemente appears in the following publications: the Nolli Map (1748), anonymous map (1775-1777), a drawing and a map by Giovanni Vasi (1781), a plan and section by Seroux D'Agincourt (1789-1823), maps by Bernardo Olivieri (1814-1817), Pietro Ruga (1824), Angelo Uggeri (1826), Filippo Troiani (1840), Stanghi (1844) and Angelo Fornari (1852). There are also a plan and perspectives by G. Fontana (1838) and an artist's impression by L. Rossini (1845) and plans and sections by Letarouilly (1845). The sections and plans by Letarouilly are the most exact representations of San Clemente at the beginning of the 19th century. The maps following accurate Nolli were more or less dated versions of Nolli's work until the end of the 19th century. The Nolli Map and the digitalization of it will be more closely discussed in Chapter 4 since it is most valuable for reconstructing the surrounding street grid in combination with Colini's general notions of the area's archaeological remains.

#### *Phase XIX*

The greatest change in the neighborhood was the new Piano Regolatore by Giuseppe Micheletti (1873). The plan consisted of several buildings to be demolished and new streets to be added. Via S. Giovanni remained the main artery with the Via Labicana. Excavations were made in the surroundings and one of the streets, Via SS. Quattro Coronati, was to follow its antique line. By 1870, the population had risen to 200,000 and was 460,000 by the turn of the century.<sup>104</sup>

Between the years 1882 and 1886, the new chapel of SS. Cyril and Methodius was built in the north aisle. It was paid for by Pope Leo XIII. The chapel divided Wing D into two. The frescoes were painted by Nobili in 1886.

San Clemente appears on the following maps: Istituto Cartografico Militare (1891, 1924 and 1949) and A. Marino and Muro Gigli (1934). There are also several photographs, including an aerial photograph from this time.

#### *Phase XX*

The continuing archaeological excavations in the neighborhood changed the outlook of the city. The Colosseum's ground floor was dug up in the 1880s and the *Ludus Magnus* revealed in the 1930s, making, along with the Colle Oppio excavations, the area more like an excavation park.

San Clemente had already achieved its present look with the renovations of Fontana. The changes during the 19<sup>th</sup> and 20<sup>th</sup> centuries were primarily caused by the excavations initiated in the 1850s. The main structural changes have been the stairs designed by C. S. Fontana's grandson during the 1870s, and the demolition of the monastery's old boiler room to restore the rib vaulted medieval space, and to solve the structural problems faced

---

<sup>103</sup> Boyle 1976, 20.

<sup>104</sup> Hibbert 1985, 230.

when excavating the baptistery between 1992 and 1995.<sup>105</sup>

Phases I-XX and the highly hypothetical Phase IVb, prove valuable when creating the site plan and reconstructions of San Clemente in the 5th century, especially since some of the furnishings and decoration in the Upper Church originate from the lower one.

The medieval Phases X-XIV are crucial for the reconstructions and their accompanying evidence, especially when trying to estimate the size of the *quadriporticus*. Since the structures are already overlapping, further overlapping cannot be ruled out. As discussed in Chapter 4.1, the archaeological remains show the curving piers in the *narthex* or *polifora* that would lead to a *quadriporticus*, as Krautheimer has demonstrated.

The urban development and its evidence from the medieval and renaissance maps are vital when joined together in creating the reconstruction site plan Drawing V (according to Drawings I-IV). The Nolli maps have often been appreciated as illustrations, but not taken seriously by archaeologists as documents of the antique urban topography. As Drawing IV proves, the correlation of archaeological evidence and digitized old maps can supplement each other. This, of course, applies best to 18th century Roman *disabitato*, but luckily, San Clemente was in the middle of the *disabitato* then.

---

<sup>105</sup> Guidobaldi 1997. At present (2015), the baptistery is not open to the public. The ribvaulted space above has been reconstructed.



Fig. 1.3.01. Room A1 in the *horrea* showing the outer envelope of *opus quadratum* and the load bearing walls in *opus mixtum* that carry the vaulting.



Fig. 1.3.02. Room Y in the *horrea* showing the load-bearing walls in *opus mixtum* that carry the vaulting. The narrow doorway is 19th century.



Fig. 1.3.03. Room M or the *Mithraeum* showing the benches for the mithraic rites and the location of the altar.



Fig. 1.3.04. *Cryptoporticus* CE and a blocked doorway (2nd century).



Fig. 1.3.05. Room AM or the anteroom to the *Mithraeum* showing one of the decorated pillars.



Fig. 1.3.06. The narrow fire alley between the *horrea* and the *domus* showing the barrel vaulting resting on the *opus quadratum* of the *horrea*.



Fig. 1.3.07. The Colosseum.

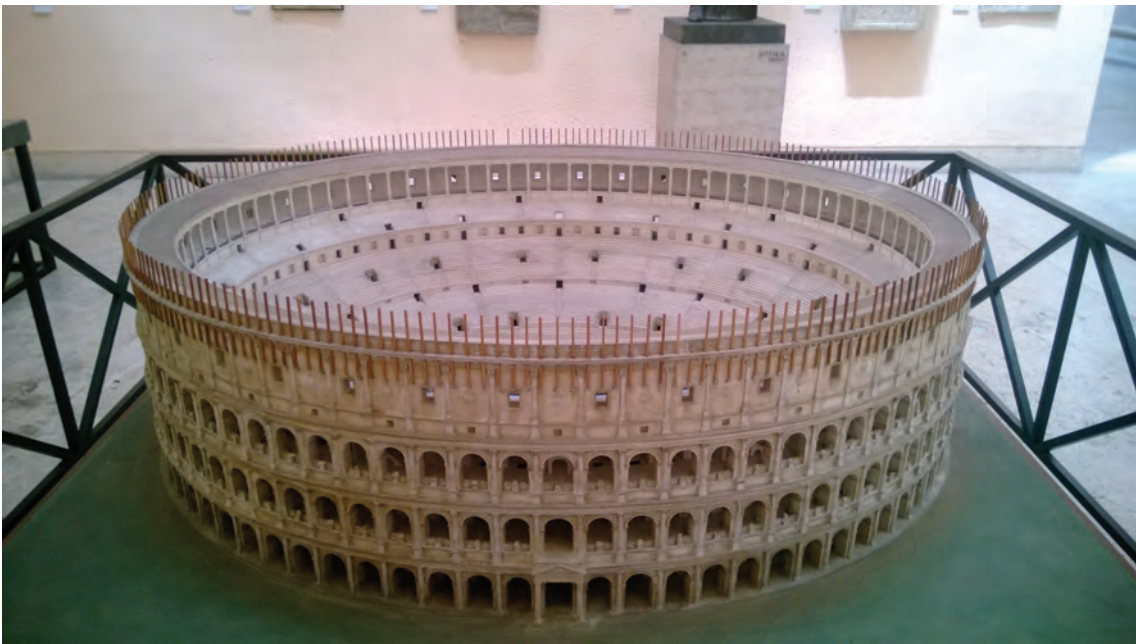


Fig. 1.3.08. Scale model of the Colosseum in the the Museo della Civiltá Romana.



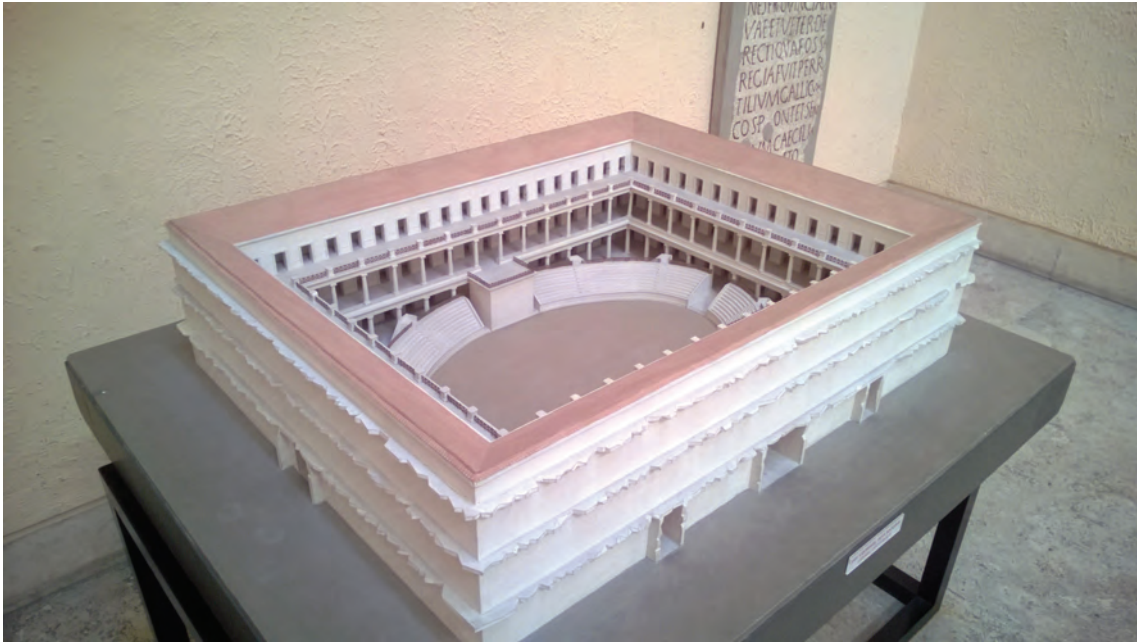


Fig. 1.3.09. Scale model of the Ludus Magnus in the Museo della Civiltà Romana.



Fig. 1.3.10. The north aisle of the Lower Church showing the remaining *spolia* columns.



Fig. 1.3.11. The south aisle of the Lower Church.



Fig. 1.3.12. The north aisle wall of the Upper Church showing the clerestory wall of the Lower Church.



Fig. 1.2.14. The baptismal font of the 6th century showing how nearly all the *opus sectile* was scrapped during the building of the Upper Church. Similar scrapping probably happened to other previous Phases.



Fig. 1.3.13. The reassembled *schola cantorum* in the Upper Church. On the right the crest of bishop Mercurius.



Fig. 1.3.15. The *quadriporticus* of the Upper Church with the *spolia* columns.

### 1.3 Literary references to San Clemente up to the 12th century

The written and epigraphical evidence for San Clemente before the 12th century is scarce. The evidence consists mainly of a couple of inscriptions on stone, a slave's collar and passing remarks on transcripts.

An inscription records the existence of a *procurator Monetae et ludi magni*.<sup>106</sup> This would place the control of both the Imperial Mint and the *Ludus Magnus* under the same person of equestrian rank.<sup>107</sup> It would be tempting to speculate that one of the few residential buildings in an area reserved for public spectacles would be the *domus* of the procurator in charge of them. According to Coarelli, the *domus* is a public building and not a residential one. On the other hand, we know a lot of offices from literary sources but no antique "office building" has yet been excavated. The *domus* probably also housed the office space of the magistrate, thus making it a building with a public function. This could probably, as has already been argued for a long time, be one of the reasons why the Roman aristocracy maintained residences in the city. The emperors held the power and were out of the city most of their reigns since the time of Trajan. Living in their own landed power bases outside the walls, they still had to perform the duties of their office. In my opinion, our modern concepts of separated living and office spaces are still too strong in the context of this discussion.<sup>108</sup>

The first epigraphic evidence relating to Clemens is on a slave collar from the Constantinian era that urges the finder to return the runaway to *a(d) dominicu(m) Clementis*.<sup>109</sup>

Jerome writes of San Clemente in *De Viris Illustribus*: *He died in the third year of Trajan and a church built at Rome preserves the memory of his name unto this day*.<sup>110</sup> In his *Dialogues*, Gregory the Great tells the story of a pious beggar, St. Servulus, in the *quadriporticus* of San Clemente.<sup>111</sup>

An inscription found on the site relates to Pope Damasus (366-384).<sup>112</sup> An inscription from 384-399, heavily reconstructed by Cecchelli, is still visible at San Clemente, and can be connected to Pope Siricius.<sup>113</sup> Pope Zosimus mentioned San Clemente in a letter in 417.<sup>114</sup> In 499 three presbyters from San Clemente confirmed a decision made by a

---

<sup>106</sup> *CIL* 6.1647. Even though fragmented, it is still reconstructable. Demougin 1997, 41-45.

<sup>107</sup> Coarelli 2007, 172-175. Coarelli states that the Imperial Mint was located there and that the domus was public. Guidobaldi, however, seems to favor a private building. Guidobaldi 1992, 114.

<sup>108</sup> For further discussion, see Tuori 2015.

<sup>109</sup> *CIL* 15.7192: *Tene me quia fug(i) et reboca me Victori acolito a(d) dominicu(m) Clementis*. Unfortunately the exact location where it was found is not known.

<sup>110</sup> Jer. *De vir. ill.* XV: *Hic obit tertio Traiani anno, et nominis eius memoriam usque hodie Romae exstructa ecclesiae custodit*.

<sup>111</sup> Gregory the Great, *Dialogues* IV.14.

<sup>112</sup> de Rossi 1870, 144.

<sup>113</sup> *S(alvo) SIR(icio) (ep)ISC(opo) ECCL(esiae sanctae) GA....PRAESBYTER (sancto) MARTYR(i) Clementi h)OC V(oluit dedicatum)*. Cecchelli 1974, 166.

<sup>114</sup> ...*Caelistius presbyter...se ingessit examini...Die cognitionis resedimus in sancti Clementis basilica... Epistolae Imperatorum Pontificum Aliorum Inde* I 99.

synod.<sup>115</sup> Presbyter Mercurius (later Pope John II) dedicates an altar in an inscription from 514-23, still preserved in the upper church<sup>116</sup>. In 533-535, Pope John II donated the still existing *schola cantorum*. In 595, two presbyters from San Clemente confirmed synodical acts.<sup>117</sup> In 731 and 741, the presbyter Gregorius likewise confirmed synodical acts.<sup>118</sup> In 741 and in 752, the presbyter Gregorius donated books to San Clemente<sup>119</sup>. Between 772 and 95, the roof was restored by Pope Hadrian I.<sup>120</sup> In 795 and in 816, Pope Leo III donated liturgical objects and Pope Gregory IV did the same in 827.<sup>121</sup> Between 847 and 855, piers, added for structural purposes, were decorated with frescoes and dedicated by Pope Leo IV.<sup>122</sup> The *inventio* of the relics of St. Clement, along with the lives of SS. Cyril and Methodius were recorded (see the description of Phase VIII, above). In approximately 1084, the narthex was nearly fully closed after the attack by Robert de Guiscard, and the election of Pope Pasqual II took place in the Lower Church in 1099. Finally, the new Upper Church was consecrated on the 26th of May 1128.<sup>123</sup>

If we are to believe Jerome, there was a church in his time called San Clemente in Rome. Whether it was on the same site or not, we cannot say for certain. At the latest, the literary evidence is certain by the beginning of 5th century. However, the *quadriporticus* can be verified by the time of Gregory's story of Servulus, whose chapel remained there until the building of Via S. Giovanni in Laterano before the end of 16th century and as I have described in Phases XV and XVI.

<sup>115</sup> Kirsch 1918, 7.

<sup>116</sup> *ALTARE TIBI D(eus) SALVO HORMISDA PAPA MERCVRIVS PB CVM SOCIIS OF..., MERCVRIVS PB SCEC.....S DNI*. De Rossi 1870, 143; Cecchelli 1974, 167.

<sup>117</sup> Kirsch 1918, 7.

<sup>118</sup> Saxer 2001, 609.

<sup>119</sup> Cecchelli 1974, 168.

<sup>120</sup> *Tectum vero tituli beati Clementis quae iam casurum erat...a noviter restauravit...* LP 1.505.

<sup>121</sup> *...in basilica beati Clementis veste de stauraci...; in ecclesia beati Clementi...veste alba...,* LP 1.505 and LP 2.76.

<sup>122</sup> *...in ecclesia beati Clementis...gabatas de argento...; in ecclesia beati Clementis...regnum qui pendet super altare maiore ex auro purissimo sculptile...; in ecclesia beati Clementis...aquammanilem...* LP 2.122, 125, 131.

<sup>123</sup> LP 2.296.

## 2 The Roman basilica and its urban context

In this chapter, I shall assemble the comparative evidence from the other basilicas in Rome. In Chapter 4, the results of the second and third chapters will be put to the test against the typology of the Roman basilicas from antiquity up to the fifth century. The results, i.e., the model created, will be compared with the antique secular basilica and the ecclesiastical basilica of early Christianity. This is in order to find the similarities and differences within the development of the typology and its relation to the *domus*. The typologies of the basilica continues up to the present, but my focus of interest is on the change of function of the type, from the multipurpose secular to a religious building with one purpose only, and I believe that the fifth century was a crucial point in this development when the building norm was established throughout the Mediterranean region. Later on, a basilica like San Clemente could be considered as a “prototype basilica”.<sup>124</sup> The surroundings of San Clemente also provide important information about the urban topography in Late Antiquity (Chapter 1.2). This is important for the Roman *Sakraltopographie* as were the Palatine patrician *domus* for the Republican Forum or the Imperial Fora and their basilicas since the function of buildings is always closely related to its surroundings. One would not put a marketplace or a court where there is no human activity. On the other hand, how and why did the Romans adopt a centuries old civic building overnight to house Christians for the next millennia? These seemingly obvious questions have not been studied at length, but I would argue, that this was architecturally and real estate-wise connected to the architecture of a Roman *domus* and its ownership.

When talking about the basilica as a building type, one cannot draw direct conclusions from its physical appearance. From antiquity to the present (the building type is still being built) the appearance has changed considerably. In the antiquity, the word “basilica” described more its function than its appearance. The basilica was most often a colonnaded hall (*hypostyle*) for large gatherings. The basilica consisted of the nave and aisles, and these two were separated from each other by a row of columns, which carried the clerestory wall or the second storey of the aisle. The building type achieved its best known appearance during the early Christian era. This basilica can be described as simply a building with a longitudinal rectangular plan with an apse. The main basic structure consisted of the nave and two or four side aisles. The side aisles could be two storied (the emporia, the aisles usually open to the main nave) or then the wall or column line that separated the aisles from the main nave continued as a clerestory wall. The windows in the clerestory wall were the main source of light for the nave.

---

<sup>124</sup> Milburn 1988, 106. Milburn also considers San Clemente being in his own words “the standard example”.

## 2.1 The civic basilica

Before the Christian basilicas, it is important to examine the civic basilica and the work of Vitruvius because they were important for late antiquity, the Carolingian renaissance and later periods. Late Antique literary evidence shows (Chapter 3.2) that Vitruvius was still read and the antique monuments were still standing for contemporary builders to copy. The aim of this chapter is to connect the whole development of the basilica to the realization of San Clemente.

The word *basilica* comes from the Greek and it probably originally meant a royal reception hall (*stoa basileia*). Despite the Greek origins of the word, no Greek basilicas have been found from the time before the Roman conquest. The closest relative in the Greek world is still the *stoa* by the *agora*.<sup>125</sup>

In the sixth century BC, the Greek *agora* was already bordered by a *stoa*. These *stoas* usually bordered the long side of an *agora*. The *stoa* is not in itself equal to the Roman basilica, but its function was much the same: to provide shelter from the weather for commercial and public activities. It is clear that the Greek *stoa* has influenced the Roman basilica.<sup>126</sup> In the Classical times, the *agora* of Athens was still a relatively undefined area with its buildings arbitrarily scattered around it.

During the Hellenistic period the *stoa* developed into a more distinguished form of urban architecture. The Stoa of Attalos was built in Athens (159-138 BC).<sup>127</sup>

The Roman basilica had the same functions at an early stage as the Greek *stoa*. In Rome, the basilica was a multipurpose building which was used for a variety of activities. We have information on its uses from several written sources: places for commercial activities, banks and money lenders and vendors, as places for public affairs and as stages for legal disputes.<sup>128</sup>

---

<sup>125</sup> Since the Greeks did not build basilicas before the Roman period, the *agora* is the closest to a basilica because of its function.

<sup>126</sup> Wheeler 2001, 111-112.

<sup>127</sup> Richardson 1992, 50. The *stoa* in itself is roughly described as a longish, semi- or fully covered columned hall. In most cases, the *stoas* were two storied. With the *stoas*, the common factor was their openness to the *agora* and their functions. The feeling which we can still experience is the immediate continuity from the open sky of the *agora* to the *stoa*'s covered colonnaded hall. The other Greek building type that should be mentioned in this context is the *bouleterion* which was a meeting place for the legislators etc. and was lined on three sides with a bench (or a circular bench). According to the archaeological evidence, the oldest actual basilica has been found on Delos. This hall-like space, which was built between 210-207 BC, does not, strictly speaking, resemble a normal basilica. The *hypostyle* hall had a central space that was higher than its aisles. The central space was so small that it would have been more likely a lantern.

<sup>128</sup> As with Basilica Iulia, Mart. 6.38.5-6 and Plin. *Ep.* 5.9.1-5 and 6.33.1-6. and Anderson 1997, 250-253.



The Roman basilica develops in a different direction in Republican Rome compared with the *stoa*. In contrast to the *stoa*'s openness and direct link to the agora, the Roman basilica underlines the importance of the interior as a feature distinct from the forum. Despite the fact that early basilicas are more like open pillar halls, the difference is clear in the attitude to the inner and outer space.<sup>129</sup> The functions remain the same, but this is crucial for the development the Christian basilica and its function.

The Roman basilica was an integral part of the forum, especially on the Italian peninsula. In the Greek-speaking parts of the Roman Empire, this was not common and the basilica is an unusual feature. As a part of the urban topography, the basilica enclosed the forum and made it a closed space. For example, in the Forum Romanum, the Basilica Iulia and the Basilica Fulvia sealed the forum into the narrowed closed space we know today.<sup>130</sup>

Basilicas were built in the rest of the Roman world as well. One of the earliest basilicas on the Italian peninsula was built during the middle of the second century BC at Cosa in Etruria.<sup>131</sup> This rectangular building represented the type described by Vitruvius, with the entrance located on the longer side of the forum. The approximately 25m long basilica otherwise represents the Vitruvian ideals (the circular aisle around the nave, which is approximately a third of the width of the nave), but it has a taller nave.<sup>132</sup>

Basilicas were not only built to house public affairs, but they were also built in large private palaces like the Domus Flavia in Rome during the first century AD. In this case, the basilica consists of a nave and aisles. On the south side of the basilica, the lines of the columns end straight in the apse. The basilica itself has probably functioned as a minor audience hall next to the major audience hall.<sup>133</sup>In Chapter 3.1 I shall consider the influence of the Domus Flavia concerning the basilica but also the nature of *aulae* in late antique *domus*.

Basilicas were built in great numbers before the early Christian basilicas. Especially from Imperial times, there are many archaeological remains of basilicas in the Imperial Fori. However, most of the information is written and some of it is questionable. However, while the list is still disputed, in Rome there were the Basilica Alexandria, Argentaria,

---

<sup>129</sup> Ward-Perkins 1994, 101.

<sup>130</sup> Steinby 2012, there are however new theories.

<sup>131</sup> Wheeler 2001, 111.

<sup>132</sup> Wheeler 2001, 112. However, there are different kinds of approaches to the design of a basilica. For example, the basilica in Pompeii, which was built in the 2nd century BC represents a different type: the entrance is on the short side from a *narthex*. This gives us a chance to simplify the matter: there might have been two different models for a basilica in the Roman world: the Pompeian and the Vitruvian.

<sup>133</sup> Ward-Perkins 1994, 78-79.

Claudii, Constantinii (Nova, or Maxentii), Floscallaria, Hilariana, Iulia, Iulia Aquiliana, Iunii Bassi, Matidie et Marcianae, Opimia, Paulli, Sempronia, Sicinini, Ulpia and Vestilia. In the following passage, I describe those for which there is enough archaeological and written evidence.<sup>134</sup>

Basilica Sempronia is one of the basilicas that followed the Basilica Porcia. It was built by Titus Sempronius Gracchus in 169 BC.<sup>135</sup> However, there are only few remains of it left because it was replaced by the Basilica Iulia, dating from 54 BC. The basilica was built by Iulius Caesar with the booty from the Gallic War. The basilica burned down and it was finished only in 12 BC and shortly after that it was again damaged by a fire (Drawing XX and Fig. 2.1.01.). The next time the basilica burned down was in AD 283 and it was repaired, which marks its importance. It consisted of a nave and two aisles that surrounded the nave on all four sides. The aisles were two stories high. The façade has 18 pillars on the long side and 8 pillars on the short side. The basilica was open to the Forum on its three sides. On the first floor, the Tuscan order was used and on the first floor the Ionic order without flutes. On the back of the basilica, there were likely *tabernae* of two stories.<sup>136</sup>

Since the 19th century, the arrangement of the Forum Romanum has been rather fixed. Later studies, however, have shown the problems concerning the exact meaning of the Latin terms used by the Romans and how they saw their meaning. In the previous general description of the arrangements in the Forum Romanum, that has been valid for the last 150 years, there might be faults concerning the real physical appearance of a Roman *porticus* and a *basilica*. This also applies to the term *titulus* (Chapter 3.0).<sup>137</sup>

The Basilica Ulpia, located in the Forum Traiani, is probably one of the largest basilicas in the Roman world. Trajan financed the basilica using his own funds and it was inaugurated in AD 112. Like the Basilicas Iulia and Paulli, the Basilica Ulpia functioned as a court of law and was used for other public functions such as an official auction chamber. As a building, the Basilica Ulpia closely resembled the Basilica Iulia because it also had two circulating aisles, but in contrast, the Ulpia has two semicircular apses at the short ends.<sup>138</sup> The basilica was two stories high and it had a clerestory wall which was

---

<sup>134</sup> See the Map IV for the urban tightness around the Forum Romanum. In general about the Forum Romanum, see LTUR I s.v. Forum Romanum.

<sup>135</sup> Livy 44.16: *T. Sempronius ... aedes P. Africani pone Veteres (tabernas) ad Vortumni signum ... emit basilicamque faciendam curavit, quae postea Sempronia appellata est.*

<sup>136</sup> De Spirito, LTUR I, 179-180, Basilica Iulia.

<sup>137</sup> Where as a *porticus* might have been seen as a basilica by the ancient authors (see Steinby 2012), the medieval authors would have seen the porticus as the basilica nave (see Immonen 2012). In a nutshell, the ancients probably did not interpret the meaning of the terminology as the classicists do nowadays.

<sup>138</sup> LTUR II s.v. Basilica Ulpia.

the main source of light for the nave. Although there are few archaeological remains of the structure, reconstructions are possible with the help of the so called “Marble Plan” from the Severan period. The roof was covered with gilt-bronze tiles.<sup>139</sup> The entrance was through the longer side from the Forum Traiani. Adjoining the basilica, there were libraries and the Column of Trajan. As compared to the previous basilicas, the Basilica Ulpia was substantially larger and more complicated. As a new feature, the apse was added to the general building program of basilicas, when the Augustan architecture was renewed in the second century. According to Dio Cassius, the whole Forum Traiani and the adjoining structures, including Trajan’s Markets, were designed by Apollodorus of Damascus.<sup>140</sup> This new architectural style, the so called “Baroque of classical antiquity” with bending and bouncing forms, achieved its final climax with Trajan’s successor Hadrian at his villa at Tivoli.

In Trier, in the Augusta Treverorum, we find one of the grandest late antique interiors. In the time of the tetrarchs, Constantine Chlorus chose this strategically located site as his seat of government in 293. Among the several building projects was a basilica, built at the beginning of the fourth century, on the site of a previous place for gathering. The massive brick walls are heavily restored nowadays, but there is no doubt of their original appearance. There is an apse at one end of the basilica, and at the other, a *narthex*. The basilica did not have aisles. Originally there were low porticos outside, along the sides. The basilica was meant to be an audience hall for the emperor and for this purpose the architects used a simple optical trick to impress people. The two rows of windows in the apse are slightly smaller than the windows on the long sides. In this way, the emperor seated in the apse would appear slightly larger than the members of audience (Fig. 2.1.02.).<sup>141</sup>

The basilica in Lepcis Magna is not open to the forum but the entrance consists of four different doors, one of which is located in an apse richly decorated with niches while two more doors are located in the portico’s northeastern corner in a separate space with pillars. Because of the non-rectangular street grid (the streets do not meet at a 90 degree angle), the basilica and the forum are differently coordinated and the space between them thus forms into a spike-like in plan. The basilica itself is a large pillar hall with apses at both short ends. The nave’s height was probably approximately 30m, assuming that there was a clerestory wall above the two storied aisles.<sup>142</sup> The similarities between the Basilica

---

<sup>139</sup> Paus. 5.12.6, 10.5.11.

<sup>140</sup> Cass. Dio 69.4.1 in a famous section, where Dion talks about the tragic murder of Apollodorus by Hadrian.

<sup>141</sup> Sear 1989, 265.

<sup>142</sup> Ward-Perkins 1994, 366-367.

Ulpia and Lepcis Magna are obvious and illustrate the rapid spread of architectural styles within the Roman Empire.

The last of the great basilicas in Rome before the Christian era was the Basilica Maxentii (later Basilica Nova or Constantini, Fig. 2.1.03.). The building was begun by Maxentius in 306, but finished by Constantine in 313 after the defeat of Maxentius. The basilica had a nave taller than the aisles. The aisles were more like niches, but they were still connected to each other by a passageway. As an exception to the other basilicas, the roof was not supported by trusses but by cross vaults. The ceilings of the niches are barrel vaulted and decorated. In the original plan, the entrance was from the short side from the eastern narthex and in the western end there was an apse.<sup>143</sup> However, Constantine changed the plan by placing the entrance on the long south side and an apse was added on the northern side.<sup>144</sup> The main source of light entered the basilica through the large arched clerestory windows and through the aisle windows. The construction technique and the handling of the light strongly resembles the baths of Diocletian or Caracalla which are also dominated by large vaulted spaces and windows. The end of the third, beginning of the fourth century was the time when architecture changed its focal point from the exterior to the interior. The Basilica Maxentii is a sort of turning point in the development of the basilica as a building type. The original plan (Maxentius) is very similar to later Christian basilicas though it had no ecclesial function.

Since the typological history of basilicas changed almost overnight after Maxentius, it is important to discuss the previous architectural development of basilicas in order to better comprehend the Christian basilica. There would be no more new civic basilicas built. The bath-like concrete construction and the vaulting of the Basilica Maxentii was still a basilica in its function. In many ways, the Christian basilica would be much more conservative in its construction than the Basilica Maxentii. The interesting question is, did Constantine's coming to power also cause architectural conservatism in the new religious buildings? The next chapter's basilicas, especially the 5th century basilicas, are more closely associated with the Republican or early imperial architecture than 3rd century architecture, especially Pope Sixtus III's architecture, which has also been called renaissance. In my opinion, the churches possibly built in a Roman *domus* and financed by their owners reflected the taste of the senatorial classes still culturally attached to their ancient values. This would change in the 6th century via the development of Byzantine architecture in buildings such as Hagia Sofia and San Vitale in Ravenna.

---

<sup>143</sup> LTUR I s.v. Basilica Maxentii.

<sup>144</sup> Richardson 1992, 53.



Fig. 2.1.01. Forum Romanum.



Fig. 2.1.02. The basilica in Trier.



Fig. 2.1.03. Basilica Maxentii in Rome.

## 2.2 The Christian basilica

In this chapter, I deal with the Christian basilica in general and formularize it to a typology to be later connected with the possible architectural influence of the Roman *domus*. In some cases, the influence of the Roman civic basilica in the development of the Christian basilica has been downplayed by previous research and caused some paradoxes.<sup>145</sup>

Constantine legalized Christianity with the Edict of Milan in 313. The persecutions of Christians have lately been shown to be overestimated. In the third century there was no exact form of liturgy or Christian building.<sup>146</sup> The Christian meetings probably took place in private buildings. From these buildings originate the terms *domus ecclesiae* and *aula ecclesiae*, which points to a private house which was used by a small congregation. There is no archaeological proof for these buildings before the third century. The early Christian services probably consisted of a common meal. As Krautheimer states, there was no Christian architecture prior to 200, but he prefers the gradual development from small houses to larger ones.<sup>147</sup>

During the third century, the need for larger meeting places had grown. The service was divided into two parts: a reading of the Holy Scripture, open to everyone, and the Eucharist, which was for the baptized alone. This kind of small congregation hall has been found at Dura Europos in Syria.<sup>148</sup> The building was located on the outskirts of the city in a poor area and it did not stand out from the rest of the city structures in any way in the same way as the neighboring synagogue. The hall was used by maybe 60 people at a time. There were some intermediate spaces and also a separate room for laymen where it was possible to listen to the service of the Eucharist without seeing it.<sup>149</sup>

The development, according to L. Michael White, moved from these modest private buildings to larger places of Christian worship (*domus ecclesiae*) up to the *aula ecclesiae* which could hold more people but was not a proper basilica. The *aula ecclesiae* consisted of a larger meeting hall, a baptistery and a martyrion.<sup>150</sup> The examples in Rome given by White are Santi Giovanni e Paolo, San Crisogono and San Clemente.<sup>151</sup> White sees the basilica more as a direct development of the *aula ecclesiae* with its functions, than

---

<sup>145</sup> White 1990, I, 17-20.

<sup>146</sup> Doig 2010, 21-53, concerning the liturgical arrangements.

<sup>147</sup> Krautheimer 1980a.

<sup>148</sup> White 1990, I, 123-131.

<sup>149</sup> Krautheimer 1986, 27-28.

<sup>150</sup> White 1990, I, 23, 127-139.

<sup>151</sup> Krautheimer 1986, 24-37. The word *aula ecclesiae* was first coined by Richard Krautheimer and later used by Michael L. White (White 1990).

an adaptation of the pre-existing building type by Constantine, forgetting the obvious connection between the secular basilica and the ecclesial basilica<sup>152</sup>.

An example of pre-basilical architecture is the Hall Church of Bishop Theodore in Aquileia. The Constantinian double-hall structure was built upon a pre-existing *domus* and bears the hallmarks of an *aula ecclesiae*. There are conflicting theories about the dating and usage of the building phases but it is safe to say, that the original *domus* dates from the first or second century AD.<sup>153</sup> The plan of the structure includes two *hypostyle* halls measuring 37×17-20m. These two halls are connected by a peristyle, an *atrium* and several smaller rooms. Architecturally, the direct relation to a *domus* is undeniable.

During the fourth century in Rome, the congregations also gathered in private buildings, the *tituli*. The term derives from the way the owner had his name posted outside the building. In the beginning of the third century, there were approximately 25 *tituli* in Rome, for example, the *titulus Clementis*, *Praxedis* and *Byzantis*. An important element of Christian life were different kinds of funeral services and the supplementary funeral dinners (*refrigeria*). In Rome, the catacombs are very famous, but outside the city walls there were also graveyards with associated buildings. In Christian building programs, we find several different kinds of monuments for martyrs, which were important for Christian services. The most famous of these places of veneration of the martyrs was Saint Peter's shrine and his reputed last resting place under the present Church of St. Peter's (more about *tituli* in Chapter 3).<sup>154</sup>

Because of the low profile of Christian life, there were no larger places of veneration. There were no large buildings, such as basilicas, for the Christians before the Edict of Milan. The only building built approximately at the time of the Edict was found in the excavations of S. Crisogono in Rome. The building was a hall of 15.5×27m, and it was flanked by modest porticoes on the outside.<sup>155</sup>

At the beginning of the fourth century, Constantine started several larger building projects for Christians. In Rome, the most important were the Lateran basilica and St. Peter's. These are the only known larger projects in Rome from that time except the deambulatory basilicas outside the walls. A common factor for both of these churches was that they were on the outskirts of the city, probably because Constantine did not want to upset the

---

<sup>152</sup> White 1990, I, 138-139. Magnusson 2004, 57, on the other hand states: *The question of the origins of the Paleochristian basilica is ultimately one for the architectural historians to solve, and it is perhaps enough to remind ourselves here that Krautheimer points out the unmistakable similarity between the five-aisled Lateran Basilica and the earlier profane basilicas such as Basilica Ulpia at Trajan's forum.*

<sup>153</sup> White 1990, II, 199-209.

<sup>154</sup> Krautheimer 1986, 32-33.

<sup>155</sup> Krautheimer 1986, 37. This would be one of the few Christian places of congregation in Rome prior to Constantine.



very influential conservative senators.<sup>156</sup> The focal point of Constantine's activities was Rome and then his new capitol Constantinople. There is little archaeological proof left for his church building activities in Constantinople. The largest of these projects was Hagia Sophia's first building phase that was soon destroyed in a revolt. This first phase was about the same size as the still standing Hagia Sophia, which means that it was very large. The basilica, which was consecrated in 360, had a nave and four aisles. The *Liber Pontificalis* mentions that Constantine and Pope Sylvester built the following churches in Rome: Basilica Constantina (S. Giovanni in Laterano), St. Peter's, S. Paul's, S. Croce in Gerusalemme, S. Agnese and the adjoining S. Costanza (mausoleum), S. Marcellino, a church for the Saints Peter, Paul and John in Ostia, a basilica for Saint John the Baptist in Albanum, a basilica for the apostles in Capua and a basilica in Naples. The *Liber Pontificalis* does not mention the projects in Constantinople or the large "twin cathedral" in Trier (320s).<sup>157</sup>

After the projects of Constantine, the basilica was the most favored building type of the Christians. The basilica had many advantages as a building type. In contrast to some pagan cults, Christianity had to accommodate large crowds indoors during the services and the liturgical procedures had to be seen by the crowd. The baptized had to be separated from the rest during the sermons, and this was possible by closing off the aisles from the nave, or by gathering the laymen into *narthexes*, aisles or – and this was a new feature – the *quadriporticus* in front of the *narthex*. The clerestory walls could be filled with windows to let in as much light as was needed in the nave.

Of the large projects, the most well known are St. Peter's and the Lateran (Basilica S. Iohannis), which was the church of the bishop of Rome. The basilica also had the name Basilica Aurea (The Golden Basilica) since it was clad in yellow marble.<sup>158</sup> These two projects were begun about at the beginning of the 4th century. Constantine himself donated the plot. The site originally housed Constantine's rival Maxentius' elite cavalry unit (*equites singulares*) and it was probably chosen so as to destroy all evidence of Maxentius' presence in Rome. The Lateran seems to be Constantine's first church built "ex novo".<sup>159</sup> The present appearance is mostly due to the renovations by Francesco Borromini in the 17th century, but the original structure still survives underneath the renovation. The Lateran was a basilica with a nave and four aisles and probably had a preceding quadriporticus. It was the first large Christian building of its kind.<sup>160</sup> The nave

<sup>156</sup> Krautheimer 1980a, 21.

<sup>157</sup> Davis 2000, 15-27.

<sup>158</sup> Lançon 2001, 27.

<sup>159</sup> Curran 2000, 93-96.

<sup>160</sup> Brandenburg 2004, 28–29. Hugo Brandenburg is quite sure that the Lateran basilica was the first of its kind and that it was a logical successor to the secular basilicas, such as the Basilica Ulpia and others in

ended in an apse where the bishop's throne and the bench for the clergy (the *synthronon*) were situated.<sup>161</sup>

The baptistery became an important part of the Roman churches later in the 5th century. A well-known example is the Lateran baptistery, the decorations of which exceed those of the basilica itself<sup>162</sup>. The places of baptism varied from mere fonts to lavish buildings. Ambrose of Milan gives us a model dedication for a baptismal font. The baptized in the early Christian period were mostly adults going through a long "teaching period" or initiation process. The font was more like a pool according to our modern standards and baptism was by complete immersion.<sup>163</sup> A baptistery was also built at San Clemente later in the 6th century.

St. Peter's was begun in the first half of the 4th century. As the earlier mentioned basilicas, the church was consecrated to the veneration of St. Peter. There was already a shrine that pilgrims visited. St. Peter's was like the Lateran – a basilica with a nave and four aisles, but differing in that there was a transept leading to St. Peter's martyrion on the south side.

Constantine also had basilica projects in Jerusalem and Bethlehem. In Bethlehem, the Church of the Nativity was finished in 333. There was a *quadriporticus* in front of the basilica. The nave and two aisles ended, not with an apse but a hexagonal chapel. In Jerusalem, the basilica had a nave, four aisles and an apse. The aisles were two-storied. The basilica on Golgotha was finished in 335. It did not have a preceding *quadriporticus*, but on the apse side, there was the Anastasis Rotunda. These two basilicas were in the same category as St. Peter's *martyria*.<sup>164</sup> The *quadriporticus* seems to have been much more frequent in Rome and in Ostia (the recently discovered basilica mentioned in the *Liber Pontificalis*).<sup>165</sup>

Previous church building had been of a changing nature, it started to evolve straight after the Edict of Milan. Constantine did not set a norm for church building, local

---

Rome, from which the architects of Constantine took their models. Unlike White, Brandenburg considers the basilica a continuous building typology. However, Brandenburg does not seem to consider the Basilica Maxentii as a relative of the Christian basilicas since it did not have proper aisles, only "large niches". Brandenburg also does not mention the importance of the side of the entrance, even though the it changes the functionality of a rectangular building completely.

<sup>161</sup> Krautheimer 1986, 50.

<sup>162</sup> Lançon 2001, 27: "...ensuring an annual revenue of 4390 solidi for the basilica and 10,234 for the baptistery. The latter was richly ornamented; if we are to believe the figures quoted in the *Liber Pontificalis*, three tons of silver and three and a half quintals (100kg) of gold were used for this purpose".

<sup>163</sup> Milburn 1988, 203-214. There are no monograph-length studies on early Christian baptisteries. See Johnson 2009, 110-177, on similarities between mausolea and baptisteries.

<sup>164</sup> Krautheimer 1986, 59-61.

<sup>165</sup> The survey, under the direction of the German Archaeological Institute in Rome (Michael Heinzelmann and Franz Alto Bauer), was begun in 1996. For the basilicas in Rome, see Table IV.

traditions and styles changed.. However, the basilica became a popular choice because of its capability of accommodating large crowds under the same roof - like St. Peter's. Seen from the outside, the basilica was a modest looking building. Emphasis was on the richly decorated interiors, as one can see from the lists of donations in the *Liber Pontificalis*. However, the lists are missing a certain feature – the decorative curtains. Such curtains, hung by a rod, for example, between the archways or entrances, can be seen in the mosaics from Sant'Apollinare Nuovo and in the inventory lists of many churches<sup>166</sup>. The curtains between the columns are shown rather frequently in early Christian art and graffiti.<sup>167</sup>

San Sebastiano (313?-337) on the Via Appia was, similarly to St. Peter's, a martyrium and a funeral basilica. The construction was probably started between 312 and 313 and it was finished around 337. The clerestory walls were carried by piers and the line of piers in the nave continued smoothly to form a semicircular ambulatory. The aisles surrounded the nave on all three sides and thus formed, with the ambulatory, a similar solution with the republican and imperial basilicas in Rome. The basilica did not have a narthex as a separate unit.

SS. Marcellino e Pietro (ca. 320s) is in many ways closer to S. Sebastiano than S. Lorenzo fm. Both funeral basilicas had a surrounding aisle and both had other mausolea in the surroundings. The greatest difference was the narthex kind of a structure that attached the basilica to the large round mausoleum, like in S. Agnese (ca. 340s, Fig. 2.2.01. and 2.2.02.), which also had a round mausoleum (S. Costanza). The clerestory walls were also supported by piers as in S. Sebastiano.

Like San Sebastiano, the original basilica by the present Via Tiburtina on the south side of the present San Lorenzo (ca. 330) was a funeral basilica. Unlike San Lorenzo, the aisles did not continue to form a surrounding arcade around the nave but the aisles started straight from the entrance and formed an ambulatory. The lines of pillars carrying the clerestory wall were stopped before the start of the ambulatory by piers and continued again with the semicircular line of ambulatory pillars. Unlike San Sebastiano, the ambulatory had large windows.

All of these *deambulatory* basilicas were built on imperial property. The already described basilicas were by major roads, outside the city center: Via Appia (San Sebastiano / Basilica Apostolorum), Via Praenestina (Tor de'Schiavi), Via Labicana (Santi Marcellino e Pietro), Via Nomentana (Sant' Agnese), Via Tiburtina (San Lorenzo) and Via Ardeatina (“Basilica

---

<sup>166</sup> Especially the last wills of private persons from late antiquity list curtains and other textiles donated to the church.

<sup>167</sup> Braconi 2012, for example, lately found piece of epigraphy showing a *consignatio*. The curtains will be discussed in detail in Chapter 2.4.

sulla Via Ardeatina”). The function of these basilicas, built in a short period of time by the imperial family, was to be commemorative buildings with adjoining mausolea. Thus, they were both for the martyrs that gave the basilicas their names, for the catacombs and for the grandeur of the imperial family. This type of basilica ceased to be built in the fifth century.<sup>168</sup> This is an interesting middle phase in Roman Christian architecture since they did not fulfill the same functions as the churches in Rome proper. However, they still were a part of the same typology, even though slightly altered. Since they were not publicly funded, it would be justified to assume that these privileges (of ownership and right of control) applied to other real estate owners as well. At least, it provides some direction when property ownership is considered in the early churches of Rome.

In the third century, Origen in *De Oratione* writes about *Domus Dei*.<sup>169</sup> Eusebius (ca. 265-340) described the start of Constantine’s church building in his *Ecclesiastical History*. According to Eusebius, the building got a new start after the persecutions of Diocletian. The demolished churches were rebuilt.<sup>170</sup> He used the terms *dominicium* and *dominicae domus* or in Greek *oikos theou*, *oikos ekklesias*, *ekklesia*, *kyriakon* and *oikos eukterios*, *basilikos oikos* and *basilikos naos*.

After the death of Constantine, ecclesiastical building projects seemed to cease for a while. Church building remained variable, but a certain model was achieved for the basilica during the fifth century. Put simply, the basilica during this time can be described as a building with a nave and two aisles, where the nave is higher than the aisles, and an apse. The *quadriporticus* was attached to the *narthex*, which was an intermediate space between the nave and the *quadriporticus*. The *narthex* had three doors or a portico (*polifora*) leading to the nave and the aisles (as in San Clemente). The middle door leading to the nave was larger than the two leading to the aisles. The interesting feature of the period, however is, the colonnaded *narthex* which I discuss below. In this period there was also a separate baptistery which could be of any shape from a circle to a hexagon, as in the Lateran. This form can be found anywhere in the Mediterranean region. Public building activities in Rome virtually ceased after the mid-fourth century. The reasons are surely manifold, starting from the fact that center of power had been wandering around the periphery, from Trier to Constantinople. Since the end of the Republic, the main financier of public building had been the emperor and the time of papal importance in public building was yet to come.<sup>171</sup> The situation improved during the pontificate of Damasus (366-384). He was an able, as nowadays would be called, fundraiser from the Roman

---

<sup>168</sup> Brandenburg 2004, 89-92.

<sup>169</sup> Origen 31.5.

<sup>170</sup> Euseb. *Hist. eccl.* 10.3-4.

<sup>171</sup> See Map IV for the distribution of churches.

elite, especially women, for the church and its building projects.<sup>172</sup> The importance of the upper classes as financiers of building are discussed in Chapter 3.2.

Church building started a busy phase throughout the fifth century in the Mediterranean region. The most important basilicas in Rome of the time were S. Vitale (401-417), SS. Giovanni e Paolo (ca. 410-420), S. Sabina (422-433), S. Paolo fuori le Mura (begun 384) and S. Maria Maggiore (432-440). The basilica saw modest changes, the most important of which are the proportions of the nave. By a rule of thumb, the proportions would be 50×150×60 RF.<sup>173</sup>

San Clemente appears as a prototypical basilica as described above that is situated with the short side on the street. The entrance was through a gate to a *quadriporticus* and then through the *narthex (polifora)* to a basilica with a nave, two aisles and an apse. The nave height was slightly lower than in comparable examples. The columns supporting the clerestory wall were reused antique columns of varying size and material. The clerestory wall had very large windows and it rested on arches and columns. Nowadays, similar effect of light can be best studied in Santa Sabina. The windows might have been thin sheets of alabaster or glass inset in stone lattices. The apse and the floors were covered by rich mosaics. When the liturgy changed in the sixth century, a marble *schola cantorum* was built in the nave and the level of the *schola cantorum* was raised above the nave level. In this enclosed area, the clergy sat during the services. The higher level made it possible for the crowd to see the proceedings. The apse level was also higher and it was equipped with a bench, the *synthronon*, and a bishop's seat where the bishop could comment on the Holy Scriptures *ex cathedra*.

Alain Doig has emphasized the importance of the nave as a secluded area for the clergy (secluded by chancel, *schola cantorum* or *solea*). This would also seem to be so in the Lateran basilica, San Pietro in Vincoli and Santo Stefano via Latina. The *solea* would be important for processions when the bishop would enter through the middle door (through the *quadriporticus* and *narthex*) culminating the procession at the apse.<sup>174</sup> The Mass itself would have required the chancel, according to Thomas F. Matthews, because of papal ceremonies, the reading of scripture, the offertory and communion.<sup>175</sup> However, at San Clemente (with an open *narthex/polifora*) there are no traces of a *schola cantorum* or *solea* before the sixth century. This has been explained by Sible De Blaauw by the late standardization of the interior arrangements of the liturgy in the eighth century.<sup>176</sup>

---

<sup>172</sup> Bowes 2008, 65-71.

<sup>173</sup> Krautheimer 1986, 170.

<sup>174</sup> Doig 2010, 91-94.

<sup>175</sup> Matthews 1962, 75.

<sup>176</sup> De Blaauw 2001.

San Paolo fuori le Mura (384, Fig. 2.2.03.) was very badly damaged in a fire in 1823. The present condition is the result of extensive restoration. San Paolo belongs to the same group of basilicas as St. Peter's and the Lateran. The basilica had a nave, an apse and four aisles. The basilica was entered through a *quadriporticus*. Moreover, the transept links San Paolo to the design of the two Constantinian basilicas.

There is not much evidence in Rome for the decoration of the basilicas from this period. Most certainly, as the descriptions of Eusebius and others attest, there were colorful marble pavements, mosaics and textiles with rich silver and gold threads. The best preserved apsidal mosaics from this period are in the Lateran baptistery (the acanthus motif), in Santa Pudenziana and in Santi Cosma e Damiano. For the clerestory wall coverings, those of Santa Sabina, the Lateran baptistery (the floral wall panels of black and yellow marble) and Santa Maria Maggiore give a good picture. Of the preserved floor pavements in marble, there are the examples of S. Stefano Rotondo (square panels with strong contrast in black and white, especially after Hugo Brandenburg's campaign).<sup>177</sup> The finest examples of vault mosaics are in Santa Costanza with figurative floral themes and dolphins (which were a common theme in the candelabras donated by Constantine, noted in the *Liber Pontificalis*). The decorations (including the columns) were reused earlier pieces during the fifth century.<sup>178</sup> All of these decorations will be used as detailing in the reconstructions in Chapter 4.2.

The basilica of San Vitale (ca. 402-417) was of the standard type, like San Clemente. The full length of the church was approximately 51m. The basilica had a nave, an apse and two aisles with a *narthex/polifora*. The present church with its restorations has preserved the original layout quite well despite the loss of the aisles. As in San Clemente, the nave was open to the outside through the *narthex*.

At the same time, San Pietro in Vincoli in Rome was also built (ca. 400). The building process had two phases: Church A and B. Church A was started sometime at the end of the fourth century and Church B was remodeled on Church A sometime in the mid-fifth century. The fine Doric columns are from the first century. The greatest change was the addition of a transept which Church A did not have.<sup>179</sup> The basilica was built on top of a luxurious *domus* with an apsidal *aula* and a peristyle.<sup>180</sup> The relevance to San Clemente is obvious.

---

<sup>177</sup> Hugo Brandenburg, *Sanctus Stephanus in Coelio Monte Santo Stefano Rotondo*, Schnell & Steiner 2010.

<sup>178</sup> Brandenburg 2004, 249-256.

<sup>179</sup> CBCR III, 226-230.

<sup>180</sup> Casti 1999, 47-58.

The same solution can be found in San Lorenzo in Lucina (first half of the fifth century). On a smaller scale, the same elements of Church A can be found in San Lorenzo in Lucina.<sup>181</sup> The only difference is the more classical appearance with pilasters from the floor up to the ceiling between the clerestory windows.<sup>182</sup>

Santa Sabina (422-432, Fig. 2.2.04.-07.) represents a kind of “peak” of Roman early Christian basilica architecture. The present window frames (reconstructions, but justified - as can be seen from the remains of the originals lying in the *narthex*) give a good picture of early Christian window frames of the time (which are used in Chapter 4.2). This basilica, located on the top of the Aventine, was heavily restored at the beginning of the 20th century and thus it got back its late antique appearance with the earlier discussed alabaster sheet windows. It is considered the model basilica of its time. It is, interestingly enough, datable to Pope Sixtus III’s so-called classical Renaissance. Compared to San Clemente, Santa Sabina had larger window surfaces and the nave proportions were higher. Santa Sabina had a very elegant early Christian appearance with the normal basilical layout – a nave, aisles, an apse and a *narthex*.<sup>183</sup>

There are several other basilicas from the first half of the fifth century in Rome. In connection with San Clemente, those of special interest are Sant’Agata dei Goti (*quadriporticus*), Sant’Anastasia (on top of an *insula*), Sant’Andrea in Catabarbara (built on top of a *domus* in an *aula*), Santa Balbina (built on top of a *domus* in an *aula*), Santa Cecilia (on top of an *insula*), Santi Giovanni a Porta Latina (built on top of a *domus*), San Lorenzo in Damaso (built next to a *domus* owned by Damasus), San Marco (built on top of a *domus* in an *aula*), Santi Giovanni e Paolo (built on top of an *insula/domus* with a *quadriporticus*), San Sisto Vecchio (*quadriporticus*) and Santi Quattro Coronati (built on top of a *domus* that had a peristyle). These related features are usually discussed in research literature in a loose manner, by dropping the names as I have just done. For this reason, I have gathered all this information on a single spreadsheet that is Table IV.

Santi Quattro Coronati is the one of the closest comparisons to San Clemente, in building history, type and proximity. The vast *aula* of the *domus* (42×15m) on the Caelian hill was transformed into a *titulus* in the late 4th or early 5th century. The rebuilding of the church by Leo IV (847-855) widened the *aula* into a basilica proper with a *quadriporticus* which might have replaced an earlier existing one of the previous *domus*. Furthermore, like probably in San Clemente, the previously existing *domus* (according to inventory list, 127 *domus* on the hill) a baptistery was added during the 6th century (the same time as that of

---

<sup>181</sup> LTUR IV s.v. Titulus Lucinae.

<sup>182</sup> CBCR II, 181-183.

<sup>183</sup> S. Episcopo, LTUR IV, 221-223.

San Clemente).<sup>184</sup>

Santa Maria Maggiore's (432-440, Fig. 2.2.08-10.) apse has later been rebuilt and moved, the original had windows. Compared to the other basilicas of the time, the arches supported by pillars were replaced by an architrave with a complex acanthus motif. The appearance of the basilica was more "classical" in the interior.<sup>185</sup>

Santo Stefano in Via Latina (ca. 450) is in many ways a prototypical basilica with the nave, two aisles, an apse and narthex. There are three entrances in the narthex, one for the nave and two for the aisles. Like S. Stefano, S. Agata dei Goti (ca. 450) also represents a prototypical basilica.<sup>186</sup> Santo Stefano in the Via Latina differs from the other fifth century basilicas in that it was built outside the walls by a pious patrician woman named Demetrias next to the peristyle of her villa.<sup>187</sup> Even though the close relation of a *domus* (or villa) to early Christian churches can be seen in Table IV, building a church directly onto a *villa* is unique in Rome (but not in the rest of Europe). However, in Rome building on top of domestic buildings would seem to be more common. As in the cases of Santi Quattro Coronati, Santa Cecilia, Santi Giovanni e Paolo and Santa Prisca (Fig. 2.2.11.-2.2.15.). The churches outside the walls have a different building chronology, like Sant' Agnese fuori le mura (Fig. 2.2.19.)

In the Western Empire, the importance of Rome slowly decreased, with Milan acting as the capital city. In Ravenna there were also great basilicas such as San Giovanni Evangelista (424-434) and Sant' Apollinare Nuovo (ca. 490, Fig. 2.2.18. and 2.2.19.). San Giovanni has seen many changes over the centuries but in the original basilica there was a pointed apse instead of the typical round one. In the apse one can find similarities with the basilicas from the Aegean region. The apse was equipped with windows like those of Santa Sabina in Rome. A similar apse can also be found in Sant' Apollinaire Nuovo.<sup>188</sup> Of the great basilicas in Milan, three deserve special mention: San Simpliciano (end of the fourth century, Fig. 2.2.20.), Sant' Ambrogio (end of the fourth century, Fig. 2.2.21.) and Santa Tecla (end of the fourth century). Unlike the Roman basilicas, San Simpliciano has a Latin cross plan. The earlier described model basilica is also represented by Saint John Studios in Constantinople (450s). Modern Istanbul does not have any further examples of this type, of which, however, examples can be found in modern Greece, the Balkans and Syria. In Salonika, the Basilica of Acheropoiotos (460-470) represents this model as

---

<sup>184</sup> Barelli 2009, 11-19; Barelli 2008, 88-91.

<sup>185</sup> M. Cecchelli, LTUR III, 105-107; Milburn 1988, 108-109. Milburn considers Santa Maria Maggiore "...a more ambitious structure in the neo-classical fashion of the times."

<sup>186</sup> M.C. Cartocci, LTUR I, 24-25.

<sup>187</sup> Bowes 2008, 94-95; Krautheimer 1971, 230-242.

<sup>188</sup> Krautheimer 1986, 192-198.



well. The only exception is that the aisles are double storied (emporio). Hagios Demetrios (end of the fourth century) also had two storied aisles. This basilica burned down in 1917 and is now heavily restored. As an exception, the colonnades supporting the clerestory consist of columns and piers.<sup>189</sup>

There are two great remains of basilicas on the modern Turkish coast: Saint John's (started in the 450s) and Saint Mary's (ca. 400). Saint John's has the form of a Latin cross and it was covered with domes instead of the usual trusses. In the middle of the cross there was a larger dome. Domes on basilicas are nearly unknown in the Western World. The dome reached its greatest glory during the reign of Justinian in sixth century Constantinople<sup>190</sup>. From the Eastern Mediterranean, there are mosaics showing the early 5th century basilicas with their curtains that will be discussed in Chapter 2.4.<sup>191</sup>

The early phases of Byzantine architecture is not the subject of this chapter, but it is worth noting that the architecture of the Roman East had already developed in a different direction since the third century. This so-called "baroque architecture of classical antiquity" as discussed by MacDonald is one of the origins of Byzantine architecture and was only short-lived in central Italy in places such as Hadrian's Villa.<sup>192</sup>

One of the finest examples is the basilica in Parenzo on the Adriatic coast (ca. 550) Along with Sant'Apollinare in Classe (532-549), this proportionally beautiful basilica in rough masonry represents the Eastern influences which were filtered through Ravenna and Istria to Western Europe during the Middle Ages.<sup>193</sup> In the Holy Land there were several basilicas started in the Constantinian era. In pilgrimage stories, such as Egeria's, we have vivid accounts of visits to some of them.<sup>194</sup>

The Aegean basilicas especially have much in common with the Italian basilicas. In modern Syria or North Africa, the differences between the basilicas during the fifth and sixth centuries are more liturgical than architectural. Of the great basilicas in Africa, one should mention the Tebessa monastery and basilica (ca. 400) with a *quadriporticus*, a basilica with two aisles and an apse. From Tabarka (North Africa) comes a mosaic representation of a modest basilica with the altar in the middle of the nave. In the Syrian

---

<sup>189</sup> Krautheimer 1986, 143-167.

<sup>190</sup> Krautheimer 1986, 170.

<sup>191</sup> Ma 3676 and Ma 3677, The Louvre Museum, Paris.

<sup>192</sup> MacDonald 1997.

<sup>193</sup> Krautheimer 1986, 141. In *Archeologia* 95 (1953) there is a drawing of the mosaic and a hypothetical reconstruction drawing of the real situation of the basilica. Since the mosaic gives a "four dimensional" picture of the basilica from the outside and inside at the same time, the set of one large archway and two smaller ones flanking the central nave has been interpreted in the article as the triumphal arch of the apse. The other possibility could be the main entrance/narthex.

<sup>194</sup> For example: John Wilkinson, *Egeria's Travels*, Oxford: Aris & Phillips 2006.

church building tradition, there were basilicas built in *opus quadratum* and not in bricks, such as Saint Paul and Moses (418), The Basilica of Kharab Shems (fourth century), the Latin cross basilica of the Qual'at Sam'aan *martyrium* (ca. 480-490) and Qalb Lozeh (ca. 450).<sup>195</sup>

At the beginning the sixth century, during the reign of Justinian, the Byzantine Empire saw a great building revival. Justinian had rebuilt the earlier destroyed Hagia Sophia, Hagia Sergius et Bacchus, and Hagia Irene, to their modern. The architects of Justinian developed a completely new approach to architecture which was also copied in the West to some extent. These magnificent microcosms with rich mosaic decorations (*Entmaterialisierung*), extremely complicated vaulting systems, and near “Baroque rhythms” of bending and twisting forms, are among the greatest achievements of architecture. Justinian’s architectural achievements were closely documented by Procopius. However, these developments fall out of the scope of the this study, and thus will not be explored in further detail.

For the purpose of the typology (Tables I and II), the closest comparisons are found in Parenzo, Tebessa, Santa Maria Maggiore, Sant’Agata dei Goti, San Sisto Vecchio and Santi Giovanni e Paolo. The next closest comparisons are San Vitale, Santa Sabina, Santo Stefano in Via Latina, San Pietro in Vincoli (Church A), San Lorenzo in Lucina and Santi Nereo e Achilleo.<sup>196</sup> The other basilicas from the same period have been used for the details in the Chapter 4 reconstructions, such as windows etc.

From Republican to Imperial times, the basilica developed greatly. A complete synthesis of the form of a basilica for the discussed period is impossible since, depending on the location of the basilica, it had several variable functions. The Romans did not see the basilica as a building type in itself but more like a commercial center or a place for public functions, courts of law and public auctions. As compared to the Greek stoa, the Romans seemed to prefer better cover from the weather.

However, certain generalizations can be made. During the Republic, the so-called Vitruvian basilica fades away as a model, and the axial Pompeian model becomes more common. The development from the more centrally spaced basilica in Cosa goes in the direction of longer buildings with a focal point, such as an apse. The integration of a basilica with the structures surrounding it becomes more common in the provinces. Whether this was the influence of Greek stoas remains to be considered more closely in a different context.

<sup>195</sup> Krautheimer 1986, 137-156.

<sup>196</sup> The examples from Group 1b that are either not from Rome or not contemporary ( $\pm 50$  years) have been left out.

During the Republic, the basilicas at the Forum Romanum were pillared or colonnaded halls, easily approachable from every corner of the forum. In the subsequent slow development, the tide turns in the direction of a controlled approach through intermediate spaces such as a *narthex*. The *narthex* was not necessarily comparable to the *narthex* of early Christian churches, but there is a certain tendency towards a more controlled approach and intermediate spaces as in Lepcis Magna. In a way, the late antique domus has the same feature of openness.

The development from the Republican basilica to the Basilica Maxentii (Constantii) is a long one. Without the changes made by Constantine, this basilica would be almost exactly the same as a Christian basilica of the fourth or fifth century, with the exception of the vaulting. The change from the marvelous barrel and cross vaulting to open timbered roof structures was perhaps more due to economic rather than stylistic reasons, given the economic depression and collapse in Late Antiquity. Barrel vaulting is exponentially more labor and material consuming. In this case, the architectural critic Rowan Moore's phrase *Form follows finance* applies. However, in spite of the move from the old basilicas of the Forum Romanum to the Basilica Maxentii, the latter is related to the basilica in Pompeii (if only in plan). The same longitudinal approach in the original plan with an intermediate *narthex* exists in both examples. The only difference is the apse. It is naturally included in the Basilica Ulpia, which, however, does not represent the Pompeian Model, as it is entered from the longer side and there are apses at both ends. There are also certain differences between the City of Rome and its provinces when it comes to basilicas. While the basilicas of Rome were civic centers, those in the provinces had more religious properties (imperial cult). The functions of provincial basilicas had less to do with civic activities than with more general representational values as parts of temples, etc.

The many basilicas reserved for the imperial cult (such as Lepcis Magna) are also noteworthy for the study of the influence of these imperial cults on basilicas and on their successive probable architectural influence on later Christian basilicas. However, it is still important to note that the secular basilica from the Republican period, the basilica of the imperial cult and the Christian basilica have similarities. And it is important to note, that private and Imperial patronage changed direction from the secular public building (and temples) to churches in the 4th century.<sup>197</sup>

During the fourth century, after the Edict of Milan, the Roman multi-purpose built basilica was adapted for ecclesiastical use. Basilicas would be used only as churches after late antiquity. Of all the basilicas from the fourth century up to the 16<sup>th</sup> century, we can

<sup>197</sup> Yasin 2010, 102-110. Ann Marie Yasin on the topic of "Roman cityscapes and honors: topographies of euergetism" providing a description of this change.

quite securely say that they were mostly traditional basilicas. There could not have been a conscious decision to use basilicas exclusively as places of worship, but the practice was gradually adapted during the two centuries after Constantine. The word “basilica” in Italian still means a church and not a particular building type. From this semantic observation, we cannot draw any direct conclusions, but in the modern Western World, a basilica plan leads our minds directly to a religious building.

Moving from Pompeii to the Basilica Maxentii, the next steps seem quite predictable. The model for a Christian place for gatherings is already at hand. For some reason, the Basilica Ulpia or the Basilica Fulvia et Aemilia still lives on in the ambulatory type basilicas of S. Sebastiano, S. Agnese, S. Lorenzo fuori le mura and SS. Marcellino e Pietro. This importance of a circulating space fades away in Rome during the fourth century. This might also have something to do with the changing nature of the Christian gathering places since the function of the martyrium also fades away. The only existing *martyria* in Rome at the moment are S. Paolo fuori le mura and St. Peter’s.

From the survey of the basilicas, we can infer a change from the beginning of the fourth century to the beginning of the fifth century. Constantine’s main priorities were to build fast and big. The Lateran basilica, St. Peter’s, and the funerary basilicas were built in rapid succession. The function of the Lateran was to be the bishop’s seat, and the others were to be shrines and funeral basilicas, but by the end of the fourth century, the bans on pagan religious activities, and the rapid growth of Christianity caused the accelerating building program of the early fifth century. The new churches were not modest places of hidden gatherings, but proud buildings in the urban fabric.

Although there are differences in the basilicas around the Mediterranean world, by and large they look the same. Local differences are only local interpretations of the same theme. As compared to the basilicas of earlier antiquity, the later Christian basilica achieves one defined function, and the standard model of the basilica, and develops an uniform appearance.



Fig. 2.2.01. The remains of the *deambulatorio*-basilica next to Santa Costanza.



Fig. 2.2.02. Santa Costanza and the arches that provide a focal point for the viewer by having a larger arch. The same is applied in the *poliforas* and also in the reconstructions of San Clemente in Chapter 4.



Fig. 2.2.03. San Paolo fuori le Mura has one of the few interiors, even though heavily rebuilt that provides a sense of what the interior of the large, secular basilicas would have been like.



Fig. 2.2.04. Santa Sabina and showing clerestory windows that are used in Chapter 4. The windows were part of the other restoration work carried by the architect and art historian Antonio Muñoz in the 1920s.



Fig. 2.2.05. Nave of Santa Sabina.



Fig. 2.2.06. Santa Sabina clerestory wall and the remains of the *opus sectile* decoration that is partly used in Chapter 4.



Fig. 2.2.07. Santa Sabina lattices design by Antonio Muñoz according to archaeological data found on site.





Fig. 2.2.08. Santa Maria Maggiore and the remaining early Christian mosaics in the clerestory wall that are partly used in Chapter 4. The classical appearance is underlined with the use of architraves instead of arches. The spiraling acanthus-motif in the architrave ties the decoration to the other examples in Chapter 4.2.



Fig. 2.2.09. Santa Maria Maggiore, view to the entrance.



Fig. 2.2.10. Santa Maria Maggiore, detail of the columns and clerestory wall.



Fig. 2.2.12. Santi Quattro Coronati, the Carolingian northern clerestory wall and columns.



Fig. 2.2.11. Santi Quattro Coronati, the Carolingian gatehouse.



Fig. 2.2.13. Santa Cecilia. One of the early Christian churches in Trastevere.



Fig. 2.2.14. Santi Giovanni e Paolo. The narthex is from 1158, but the five arches in the upper part of the nave were restored visible in the 20th century. The five arches repeat the same theme seen in late antique architecture, i.e., making the central arch larger than the rest.



Fig. 2.2.15. Santa Prisca. The site of the early Christian church built on top of a *domus* (Drawing XXVIII).



Fig. 2.2.16. Sant'Agnese fuori le mura. One of the few churches in Rome with an *emporio* over the aisles.



Fig. 2.2.17. Chiesa della SS. Annunziata in Paestum. This heavily restored small basilica shows the early Christian space without decoration. The basilica is from the beginning of the 5th century and was built with a *polifora*, which was subsequently closed a century later. In my opinion this basilica and Paulinus' nearby basilical complex at Nola illustrates the short "fashion" of open *poliforas*.



Fig. 2.2.18. Basilica di Sant'Apollinare Nuovo, façade.



Fig. 2.2.19. Basilica di Sant' Apollinare Nuovo, nave and the clerestory mosaics.



Fig. 2.2.20. San Simpliciano or, Basilica Virginum commissioned by St. Ambrose in Milan. The original clerestory windows are the same size as those in San Clemente but not the “keyhole”-version.



Fig. 2.2.21. Sant' Ambrogio or the Basilica Martyrium that is mentioned in Chapter 3.3.

## 2.3 Literary evidence on basilicas from Vitruvius to Paulinus of Nola

Because the literary evidence for San Clemente is scarce (Chapter 1.3), I use comparative evidence from the same period to create a context for the reconstructions in Chapter 4.2. The earlier literature is also crucial since, for example, Sidonius Apollinaris (430-489) for example, still makes remarks about Vitruvius, which proves that he was still read in wider circles.<sup>198</sup> In this case, by a bishop who wrote vivid descriptions of both basilicas and domestic architecture (Chapter 3.2).

Vitruvius describes the relationship of a basilica to a forum. Considering the forum inseparable from the basilica, we can also assume that “basilica” as a word is mainly defined as a function and not as a form.<sup>199</sup>

Vitruvius does not necessarily represent the common view on the subject in his time, but instead a personal view as a private architect. He was an army official (an engineer) and he intended his *De architectura* as a sort of “architect’s portfolio” for a potential imperial customer or patron. Vitruvius also describes a basilica of his own design. From this description, one can easily imagine the finished structure. Such a structure was in a colony founded by Augustus. Vitruvius gives the measurements of the basilica as follows: the main nave 120×30 RF, the aisles 20RF wide, the columns 50RF high and 5RF in diameter.<sup>200</sup> The crucial text concerning the proportions of the basilica and its urban context is:

*1. The Greeks plan the forum on the square with most ample double colonnades and close-set columns; they ornament them with stone or marble architraves, and above they make promenades on the boarded floors. But in the cities of Italy we must not proceed on the same plan, because the custom of giving gladiatorial shows in the forum has been handed down from our ancestors.*<sup>201</sup>

Vitruvius has a clear purpose in pointing out the difference between Greek and Roman urbanism. The *stoa* is mentioned, but Vitruvius prefers the Roman way of separating the functions of business and law from more mundane socializing (partially because of the gladiatorial games that were played at the Forum Romanum until the early Imperial period):

---

<sup>198</sup> Sid. Apoll. *Epist.* 7.6,10.

<sup>199</sup> Vitr. 5.1.1-10.

<sup>200</sup> RF = Roman Feet, ca. 0.296m.

<sup>201</sup> Vitr. 5.1.1.1: *Graeci in quadrato amplissimis et duplicibus portius fora constitunt crebrisque columnis et lapideis aut marmoreis epistylis adornant et supra ambulationes in contignationibus faciunt. Italiae vero urbibus non eadem est ratione faciendum, ideo quod a maioribus consuetudo tradita est gladiatoria.*



2. For that reason more roomy intercolumniations are to be used round the spectacle; in the colonnades, silversmiths' shops; and balconies, rightly placed for convenience and for public revenue, are to be placed on the upper floors. The dimensions of the forum ought to be adjusted to the audience lest the space be cramped for use, or else, owing to a scanty attendance, the forum should seem too large. Now let the breadth be so determined that when the length is divided into three parts, two are assigned to the breadth. For so the plan will be oblong, and the arrangement will be adapted to the purpose of the spectacles. 3. The upper columns are to be a quarter less than the lower ones; because the lower columns ought to be stronger for bearing weight than the upper ones. Not less one ought also to imitate the natural growth of trees, as in tapering trees, the fir, the cypress, the pine, of which everyone is thicker at the roots. Then diminishing it rises on high, by a natural contraction growing evenly to the summit. Therefore since the nature of growing plants so demands, things are rightly arranged both in height and thickness, if the higher are more contracted than the lower. 4. The sites of basilicas ought to be fixed adjoining the fora in as warm a quarter as possible, so that in the winter, business men may meet there without being troubled by the weather. And their breadth should be fixed at not less than a third, nor more than half their length, unless the nature of the site is awkward and forces the proportions to be changed. When the site is longer than necessary the committee rooms are to be placed at the end of the basilica, as they are in the Basilica Julia at Aquileia 5. The columns of basilicas are to be of a height equal to the width of the aisle. The aisle is to have a width one third of the nave. The columns of the upper story are to be less than those below as herein above specified. The parapet between the upper and lower columns ought to be one fourth less than the upper columns, so that people walking on the first floor may not be seen by persons engaged in business. The architraves, friezes and cornices are to be designed in accordance with the columns, as we have prescribed in the third book.<sup>202</sup>

<sup>202</sup> Vitruvius 5.1.2.-5.2: munera in foro dari. Igitur eircum spectacula spatiosiora intercolumnia distribuuntur cireaue in porticibus argentariae tabernae maenianaue superioribus coaxationibus conlocentur; quae et ad usum et ad vectigalia publica recta crunt disposita. Magnitudines autem ad copiam hominum oportet fieri, ne paruum spatium sit ad usum, aut ne propter inopiaril populi vastum forum videatur. Latitudo autem ita finiatur uti, longitudo in tres partes enun divisa fuerit, ex his duae partes ei dentur; ita erit oblonga eius formatio et ad spectaculorum 3. rationem utilis dispositio. Columnae superiores quarta parte minores quam inferiores sunt constituendae, propterea quod oneri ferendo quae sunt inferiora firmitiora debent esse quam superiora. Non minus quod etiam nascentium oportet imitari naturam, ut in arboribus teretibus, abiete, cupresso, pinu, c quibus nulla non crassior est ab radicibus, dein decrescendo proceditur in altitudinem natural contractura peracquata nascentium ad cacumen. Ergo si natura nascentium ita postulat, recte est constitutum et altitudinibus et crassitudinibus superiora inferiorum fieri contractiora. 4. Basilicarum loca adiuncta foris quam calidissimis partibus oportet constitui, ut per hiemem sine molestia tempestatum se conferre in cas negotiatores possint. Earumque latitudines ne minus quam ex tertia, ne plus ex dimidia longitudinis constituentur, nisi si loci natura inpedierit et aliter coegerit symmetriam commutari. Sin autem locus erit amplior in longitudine, chalcidica in extremis constituentur, uti 5. sunt in lulia Aquiliana. Columnae basilicarum tamen altae, quam porticus latae fuerint,

In the following passage, the measurements are clearly stated, but no such basilica has been yet excavated: 6. *At the Julian Colony of Fano, I let out for contract and superintended the building of a basilica not inferior to these in dignity and grace. Its proportions and harmonies are as follows: There is a vaulted nave between the columns 120 feet long and 60 broad. The aisle between the columns of the nave and the outside wall is 20 feet wide. The columns are of an unbroken height, including the capitals, of 50 feet with a diameter of 5 feet. Behind them adjoining the aisle are pilasters 20 feet high, 2-1 feet wide and 11 feet thick. These carry the beams under the flooring. Above, there are pilasters 18 feet high, 2 feet wide and 1 foot thick, which take the beams which carry the principals of the main roof and the roofs of the aisles which are lower than the vaulting of the nave. 7. The space which remains in the intercolumniations, above the pilasters and below the tops of the columns, admits the necessary lighting. In the width of the nave counting the angle columns right and left, there are four columns at each end. On the side adjoining the forum, there are eight, including the angle columns. On the other side there are six, including the angle columns. The two columns in the middle are omitted, so as not to obstruct the view of the pronaos of the Temple of Augustus which is situated in the middle of the side wall of the basilica and faces the middle of the forum and the Temple of Jupiter. 8. The tribunal which is in the former temple is in the shape of the segment of a circle. The width of the segment in front is 46 feet; its depth is 15 feet; so that those who come before the magistrates may not interfere with persons on business in the basilica. Above the columns are beams made of three 2 foot joists bolted together. These return from the third column on either side of the opening to the antae of the pronaos, and adjoin the curve of the tribunal right and left. 9. Above the beams vertically over the capitals, piers are placed on supports, 3 feet high and 4 feet square. Above them, beams formed of two 2 foot joists, carefully wrought, are carried round the basilica. Thereon over against the shafts of the columns, and walls of the pronaos, cross-beams and struts support the whole ridge of the basilica, and a second ridge running out from the middle of the main ridge, over the pronaos of the temple. 10. Thus there arises from the roof a double arrangement of gables. This gives a pleasing effect both to the exterior of the roof and to the high vaulting within. Further, we dispense with the ornaments of the entablatures and the provision of the upper columns and parapets. We are relieved from laborious details and escape a large expenditure, while the carrying up of the columns without a break to the beams of the vault seems to give a sumptuous magnificence and impressiveness to the work.*<sup>203</sup>

*faciendae videntur; porticus, quarn medium spatium futururn est, ex minores quarn inferiores, uti supra scriptum est, constituentur. Pluteum, quod fuerit inter superiores et inferiores columnas, item quarta parte minus, quam superiores columnae fuerint, oportere fieri videtur, uti supra basilicae contignationem ambulantes ab negotiatoribus ne conspiciantur. Epistylia zophora coronae ex symmetriis columnarum, uti in tertio libro diximus, explicentur.*

<sup>203</sup> Vitruvius 5.1.6.-1.10: *Non minus summam dignitatem et venustatem possunt habere conparationes basilicarum, quo genere Coloniae luliae Fanestri conlocavi curavique faciendam, cuius proportionones et symme-*

The relevant part of the given proportions are in Table I since it seems that these proportions are achieved in San Clemente, and not in civic basilicas. As noted before, this might have some connection with the use of Vitruvius in Late Antiquity.

To begin with, the basilica was used for banking and related business but later on it was used for the *centumviri* (180 men in reality) who handled disputes on inheritance. There are remarks by Pliny and Quintilianus on the function of the Centumviri. In his letters Pliny, comments on the juridical functions of the basilica in a law case.<sup>204</sup> In another remark in a letter to Romanus, Pliny writes about a law case in the Basilica Iulia: *The Court was composed of one hundred and eighty jurors (for that is the number of which four panels consist); a host of advocates appeared on both sides; the benches were infinitely thronged, and the spacious court was encompassed by a circle of people standing several rows deep. In addition, the tribunal was crowded, and the very galleries lined with men and women, hanging over in their eagerness to hear (which was difficult) and see (which was easy).*<sup>205</sup> Quintilianus remarks on Cicero as a speaker in the Basilica Iulia: *with a voice which was almost a tragedian's* during a law case when four different cases were

*triae sic sunt constitutae. Mediana testudo inter columnas est longa pedes cxx, lata pedes LX. Porticus eitis circa testudinem inter parietes et columnas lata pedes XX. Columnae altitudinibus perpetuis cum capitulis pedes L, crassitudinibus quinum, habentes post se parastaticas altas pedes XX, latas pedes II s, crassas I.S, quae sustinent trabes, in quibus invehuntur porticum contignationes. Supraque eas aliae parastaticae pedum XVIII, latae binum, crassae pedem, quae excipiunt item trabes sustinentes cantherium et porticum, quae sunt summissa infra testudinem,*

7. *tecta. Reliqua spatia inter parastaticarum et columnarum trabes per intercolumnia luminibus sunt relicta. Columnae sunt in latitudine testudinis cum. angularibus dextra ac sinistra quaternae, in longitudine, quae est foro proxima, cum isdem angularibus octo, ex altera parte cum angularibus VI, ideo quod mediae duae in ea parte non sunt positae, ne impediunt aspectus pronai aedis Augusti, quae est in medio latere parietis basilicae conlocata spectans*

8. *medium forum et aedem Iovis. Item tribunal quod est in ea aede, hemicycli schematis minoris curvatura formatum; eitis autem. hemicycli in fronte e t intervallum pedes XLVI, introrsus curvatura pedes xv, uti, qui apud magistratus starent, negotiantes in basilica ne impedirent. Supra columnas ex tribus tignis bipedalibus compactis trabes sunt circa conlocatae, eaeque ab terflis columnis quae sunt in interiore parte, revertuntur ad antas quae a pronao procurrunt, dextraque et sinistra hemicyclium tan*

9. *gunt. Supra trabes contra capitula ex fulmentis dispositae pilae sunt conlocatae, altae pedes iii, latae quoqueversus quaternos. Supra eas ex duobus tignis bipedalibus trabes everganae circa sunt conlocatae. Quibus insuper transtra cum capreolis columnarum contra corpora et antas et parietes pronai conlocata sustinent unum culmen perpetuae basilicae, alterum*

10. *a medio supra pronam aedis. Ita fastigiorum duplex tecti nata dispositio extrinsecus tecti et interioris altae testudinis praestat speciem venustam. Item sublata epistylorum ornamenta et pluteorum. columnarumque superiorum distributio operosam detrahit molestiarum sumptusque inminuit ex magna parte summam. Ipsae vero columnae in altitudine perpetua sub trabe testudinis perductae et magnificentiam impensae et auctoritatem operi adaugere videntur.*

<sup>204</sup> Plin. Ep. 5.9.1-2: *Descenderam in basilicam Iuliam auditurus, quibus proxima comperendinatione respondere debebam. sedebant iudices, decemviri uenerant, obuersabantur aduocati; silentium longum, tandem a praetore nuntius; dimittuntur centumviri, eximitur dies.*

<sup>205</sup> Plin. Ep. 6.33-3-4: *Sedebant iudices centum et octoginta (tot enim quattuor consiliis colliguntur), ingens utrimque aduocatio et numerosa subsellia, praeterea densa circumstantium corona latissimum iudicium multiplici circulo ambibat. Ad hoc stipatum tribunal, atque etiam ex superiore basilicae parte qua feminae qua uiri et audiendi, quod difficile, et quod facile, uisendi studio imminebant.*

being tried simultaneously.<sup>206</sup> From these passages, we can imagine the crowded reality at secular functions in a basilica. These buildings of considerable size were not only built to impress, but they were used to take full advantage of their physical dimensions. Suetonius' relates how Caligula threw money to the poor from the rooftop of the basilica.<sup>207</sup>

Tacitus discusses about the restoration of the Basilica Pauli by Marcus Lepidus in AD 22: *Nearly at the same time, Marcus Lepidus asked permission from the senate to strengthen and decorate the Basilica of Paulus, a monument of the Aemilian house, at his own expense. Public munificence was a custom still; nor had Augustus debarred a Taurus, a Philippus, or a Balbus from devoting the trophies of his arms or the overflow of his wealth to the greater splendour of the capital and the glory of posterity: and now Lepidus, a man of but moderate fortune, followed in their steps by renovating the famous edifice of his fathers.*<sup>208</sup>

There is not much written evidence for the physical form of the basilica from the pre-Constantine era. The remarks of Christian writers concern merely the inner arrangements and furniture of church buildings. Cyprian, Bishop of Carthage (ca. 249-258), talks about a raised pulpit "*upon the tribunal of the church*".<sup>209</sup> A text from the late third century concerning the seating order in the church has been found in Syria. According to the text, the presbyters should be placed in the eastern part, the bishop in their midst, the laymen facing east, "*as knowing that which is written*", one should pray facing east. The instructions continue at length on the seating arrangements for men, women, unmarried girls, people from other congregations etc., but what is evident from the Syrian text is that the congregation was seated during the service.<sup>210</sup> Gregory Thaumaturgus, Bishop of Neocaesarea (ca. 240-270), gives a more detailed description of the building layout where

---

<sup>206</sup> Quint. *Inst.* 12.5.5-6: *Habuit oratores aetas nostra copiosiores, sed, cum dicret, eminere inter aequalis Trachalus uidebatur. ea corporis sublimitas erat, is ardor oculorum, frontis auctoritas, gestus praestantia, uox quidem non, ut Cicero desiderat, paene tragoedorum, sed super omnis, quos ego quidem audierim, tragoedos. certe cum in basilica lulia diceret primo tribunali, quattuor autem iudicia, ut moris est, cogentur atque omnia clamoribus fremerent, et auditum eum et intellectum et, quoci agentibus ceteris contumeliosissimum fuit, laudatum quoque ex quattuor tribunalibus memini. sed hoc uotum est et rara felicitas.*

<sup>207</sup> Suet. *Calig.* 37.1: *(Caligula) nepotatus sumptibus omnium prodigorum ingenia superavit. . . «aut frugi hominem esse oportere» dictitans «aut Caesarern». quin et nummos non mediocris summae e fastigio basilicae luliae per aliquot dies sparsit in plebem.*

<sup>208</sup> Tac. *Ann.* 3.72: *Isdem diebus M. Lepidus ab senatu petiuit ut basificam Pauli, Aemilia monumenta, propria pecunia firmaret ornaretque. Erat etiam tum in more publica munificentia; nec Augustus arcuerat Taurum, Philippum, Balbum hostilis exuvias aut exundantis opes ornatum ad urbis et posterum gloriam conferre. Quo tum exemplo Lepidus, quamquam pecuniae modicus, auitum decus recoluit.*

<sup>209</sup> Cyprian, *Epistula* 39.4.1.

<sup>210</sup> *Didascalia Apostolorum* 12 (44b-46b).

he, in his instructions, mentions the house of prayer, the *narthex* and the sanctuary.<sup>211</sup> According to Luca Crippa, among the Syrian texts, the *Testamentum Domini* gives a pre-Constantinian description of the basilica which includes a separate baptistery in the *quadriporticus* and a church hall with aisles (*porticus*), one for the women and one for the men.<sup>212</sup>

In Rome, Callixtus built a basilica in Trastevere at the beginning of the 3rd century.<sup>213</sup> Its exact appearance is not known, but it would be plausible that the form would have fewer than three aisles since the first archaeological evidence for them is from the Constantinian period. Another piece of literary evidence in Rome mentions a basilica built by Felix I on the Via Aurelia where the bishop was also buried.<sup>214</sup> The organization of the early Roman *tituli* is attributed to Marcellus. An early clue for the *tituli* is given in the same passage of the Liber Pontificalis, where a certain widow named Lucina donates her house to be used as a *titulus*.<sup>215</sup>

Eusebius recorded the new rise in church building after Constantine's victory:

*And after these things there came to pass the spectacle for which we all had prayed and longed, namely festivals of dedication in every city and consecration of the newly-built houses of prayer; ...*<sup>216</sup>

Eusebius, one of the most important church historians, gives an account of the new church built by Bishop Paulinus:

*37. Thus, then, the whole area that was enclosed was much larger (than previously). The outer enclosure he fortified with a wall surrounding the whole, so that it might be a secure courtyard for the whole. 38. He spread out a gateway, great and raised on high toward the very rays of the rising sun.... 39. But he did not permit the one passing inside the gates to come immediately with unholy and washed feet upon the holy places within. Marking of a great expanse between the temple and the first gates he adorned all around it with four transverse stoai, which enclosed the area in a kind of quadrangular figure with columns raised on all sides.....and left an atrium in the middle.....40. Herein (the atrium) he placed symbols of holy purification (fountains). 41. And verily, passing from this spectacle, he made the entry passages to the temple wide openings by means of still*

---

<sup>211</sup> Gregory of Nyssa, *Epistula canonica*, Canon 11 ca. 265.

<sup>212</sup> Crippa 2003. This could be one possible explanation for the absence of a baptistery in the early 5th century since the excavated baptistery at San Clemente is from the sixth century.

<sup>213</sup> LP 17.4.

<sup>214</sup> LP 27.2.

<sup>215</sup> LP 31.2.-4.

<sup>216</sup> Euseb. *Hist. eccl.* 10.3.1.

more innermost gateways. Once again under the rays of the sun he placed on one side three gates, of which he favoured the middle one in height and breadth to surpass far beyond those on either side... Eusebius continues on the lavish decorations of wood and the bronze decorations of the gates. According to him, the bishop himself would be “set in their midst at the altar, the holy of holies. The pavements were of finest marble with ornaments...<sup>217</sup>”.

A similar description appears on a sarcophagus lid (although not as laudatory as Eusebius’) in the epitaph of Marcus Julius Eugenius (ca. 307-340) ...; *and having rebuilt the entire church from its foundations and all embellishments around it, which contain stoa and tetrastoa, paintings, mosaics, a fountain and an outer gateway, and having furnished it with all the masonry construction and,...*<sup>218</sup> In short, the brief description resembles that of Eusebius.

The projects of Sylvester’s pontificate are well known. Even though the majority are Constantine’s, Sylvester also built a *titulus* of his own. Titulus Silvestri seems to have been purely of his own organizing unlike the Titulus Equitii, which was built on the estate of one of his priests (Equitus). The endowments (the furnishings) of these *tituli* have been far simpler than for Constantine’s Lateran Basilica (399 solidi for Equitii and 405 solidi for Silvestri).<sup>219</sup>

Constantine’s endowments for furnishings provide a scale of the relative sizes between *tituli* and Constantine’s basilicas. For the Lateran Basilica, these annual endowments were: 4390 solidi for the basilica’s lighting and 10,034 solidi for the baptistery’s upkeep.<sup>220</sup> As Peter Brown states, the early churches were more than adequately lit 24/7.<sup>221</sup>

Prudentius describes San Paolo fuori le mura as follows:

*Elsewhere the Ostian Road keeps the memorial church of Paul, where the river grazes the land on its left bank. The splendour of the place is princely, for our good emperor dedicated this seat and decorated its whole extent with great wealth. He laid plates on the beams so as to make all the light within golden like the sun’s radiance at its rising, and supported the golden-paneled ceiling on pillars of Parian marble set out there in four rows. Then he covered the curves of the arches with splendid glass of different hues, like meadows that are bright with flowers in the spring.*<sup>222</sup>

<sup>217</sup> Euseb. *Hist. eccl.* 10.4.36-46.

<sup>218</sup> MAMA 1.170 Asia, Phrygia/Pisidia.

<sup>219</sup> LP 34.3 and 34.33.

<sup>220</sup> LP 34.12 and 34.14.-15.

<sup>221</sup> Brown 2012, 524-526.

<sup>222</sup> Prudent *Peristephanon Liber* 12.45-54: *Parte alia titulum Pauli via servat Ostiensis, qua stringit amnis*

Concerning the churches in Palestine, there is a vivid description by Eusebius of the Church of the Holy Sepulcher:

*...the inner surface of the building was hidden beneath layers of polychrome marble: the ceiling was decorated with carved panels which, resembling a great sea, surged continuously over the whole basilica and the glistering gold with which the ceiling was covered made the whole shrine sparkle with a thousand reflected lights... The outer aspect of the walls, bright with polished stone admirably laid presented an unusual beauty in no way inferior to that of marble. As regards the roof, its outer surface was covered over with lead, a sure protection against the winter rains.*<sup>223</sup>

Prudentius describes the baptistery of St. Peter's: *There is an inner part of the memorial where the stream falls with a loud sound and rolls along in a deep, cold pool. Painting in diverse hues colours the glassy waves from above, so that mosses seem to glisten and the gold is tinged with green...*<sup>224</sup>

In a letter from 326 to the bishop Makarios of Jerusalem, Constantine writes that the costs will be paid especially for two features: the marble and if the ceiling is to be paneled, it has to be gold-plated.<sup>225</sup> This would again stress the importance of *opus sectile* and expensive materials which were absent from the archaeological data of San Clemente since they were probably reused in later building phases.

Compared to the Roman archaeological evidence, the *Liber Pontificalis* mentions a small number of churches built directly by bishops. During the period spanning 350, years, there are only 25 churches in the *Liber Pontificalis* but only two were financed by private individuals. Given the propagandist nature of the *Liber Pontificalis*, it would be best to presume that the majority of the archaeological evidence does not correlate with the *Liber Pontificalis*. As discussed below, the research on early church building has gone through major changes starting with Charles Pietri.

Paulinus Nolanus (Paulinus of Nola 354/355-431) writes to his friend Severus at the same time about the building project of Basilica Nova in modern Cimitile in southern Italy (Fig. 2.3.01. and 2.3.02.). Paulinus describes the shrine of Saint Felix and the transept and the new openings between the old basilica and the new one. Paulinus gives us a vivid description, in the manner of Eusebius, of the fine decorations and arrangements in the

---

*caespitem sinistrum. Regia pompa loci est; princeps bonus has sacravit arces lusitque magnis ambitum talentis. Bratteolas trabibus sublevit, ut omnis aurulenta lux esset intus, ceu iubar sub ortu. Subdibit et Parias fulvis laquearibus columnas, distinguit illic quasquaternus ordo. Tum camiros hyalo insigni varie cucurrit arcus: sic prata vernis floribus reident.*

<sup>223</sup> Euseb. *Hist. eccl.* 3.43.

<sup>224</sup> Prudent *Peristephanon Liber* 12.39-43.

<sup>225</sup> Mango 1986, 15.

basilica. Moreover, in this case, there are the *quadriporticus*, three doorways and lavish decorations.<sup>226</sup>

In many ways, Paulinus is the best source for the appearance of the early Christian basilica.<sup>227</sup> In his Epistle 32 to Sulpicius Severus (404), Paulinus tells him about his new basilica. The epistle has an extensive description of the apse mosaic and its symbolism and discusses the text he intended to place there. There is also a description of a coffered ceiling.<sup>228</sup> The epistle continues with a description of side rooms (*cubicula*) used for various purposes. Paulinus describes the orientation of the basilica, where the apse faces east, unlike many of the Roman basilicas – including San Clemente. In this same passage, Paulinus describes the procession through these various parts of the whole complex. Since Epistle 32 is of utmost importance for the reconstructions of Chapter 4.2 and a valuable description of a building process from the viewpoint of a client, I quote those parts of the letter that are important for the reconstructions and Chapter 3 concerning the *domus* and *titulus*:

*To Severus*<sup>229</sup>

*1. When I had enclosed those poor verses, the open page made advances to my tongue and hand to fill out the empty spaces, and it struck me that I had something to write. I am highly delighted that we have together exhibited the one appearance of heart and body, and of works and dedications as well, by simultaneously bestowing basilicas on the Lord's folds. But you have also constructed a baptistery between your two basilicas, so that you surpassed me in the erection of visible buildings as well as invisible works...*

Paulinus starts with the cordialities and objects to Severus' idea of including him in the dedications of his basilicas. He continues with the possible verses that might be used in them:

*5. So I have also written some little verses for your basilicas like votive inscriptions for sacred fountains. If any of my lines shall seem apposite, the credit for this, too, is brother Victor's, for it is through his eyes and words that I have witnessed all that you have done*

<sup>226</sup> Brandenburg 2007, 119-120; Crippa 2003, 100-122.

<sup>227</sup> Dr. Tomas Lehmann published in 2004 his "Paulinus Nolanus und die Basilica in Cimitile/Nola – Studien zu zentralen Denkmal der spätantik-frühchristlichen Architektur". In this study, Lehmann covers the previous excavations of the basilica, Paulinus' own writings about the basilica and creates in the end a reconstruction of the basilica with the given information. These most important writings by Paulinus are Epistle 32 and Carmens 32, 27, 28 and 19. Unfortunately within the frame of this study, it would be impossible to cover these lengthy texts in total so I shall only keep to the basics of these texts, which are of importance to the reconstruction as comparative evidence here.

<sup>228</sup> Paulinus *Ep.* 32.287,11-288,10: *Totum vero extra concham basilicae spatium alto et lacunato culmine geminis utrimque porticibus dilator, quibus duplex per singulos arcus columnarum ordo dirigitur.*

<sup>229</sup> Translation from Walsh's edition of *Letters of St. Paulinus of Nola* (1966).



*and continue to do in Christ the Lord. So you will assess these additional verses which I have inserted about the basilicas as written by him, for he dictated the contents by telling me of your works. The following lines will describe the baptistery, for the previous ones described only the murals there.*

*Here the spring which fathers newborn souls brings forth water living with divine light. The Holy Spirit descends on it from heaven, and mates its sacred liquid with a heavenly stream. The water becomes pregnant with God, and begets from seed eternal a holy offspring in its fostering fount. Wondrous is God's fatherly love, for the sinner is plunged into the water and then comes forth from it justified. So man achieves a happy death and birth, dying to things earthly and being born to things eternal. His sin dies, but his life returns. The old Adam perishes and the new Adam is born for eternal sway.*

*Severus, most chaste of Christ's dwellers in body, mind, and faith, has in joy built this house for God. He is himself wholly a temple of God, and thrives with Christ as his guest, bearing in humble heart the glad Lord. And just as he worships one Mind under three names, so here he has dedicated a threefold work of sacred building. On the twin structures he has set for his people splendid roofs so that their number might harmonise with the sacred Laws. For just as the one Proposer stipulated two Testaments, joining Christ with God in the one faith, so Severus has set his baptistery with tower-shaped dome between two churches, so that Mother Church may joyfully receive in twin bosoms the newborn offspring brought forth by water. The twin-roofed basilicas represent the Church with two Testaments; the single baptistery lending grace adjoins both. The Old Law strengthens the New, the New fulfils the Old. Hope lies in the old, Faith in that which is new. But Christ's grace combines Old and New, so the baptistery is placed between the two. From it the priest our father raises from the consecrated water children snow-white in body, heart and dress. These novice-lambs he leads round to the festive altars, and introduces their uninitiated moths to the Bread of salvation. Here the crowd of elders, a gathering of friends, shares the rejoicing. The fold bleats in fresh chorus: Alleluia!*

This first of all tells us that there were already two basilicas before Severus built a baptistery. Severus' position resembles that of Paulinus - several religious buildings and their different religious functions are used like joints to create a whole ecclesiastic artwork with the guiding verses painted or laid out in mosaic. The descriptions immediately bring to mind the Lateran baptistery, which is a freestanding building, but still part of a whole. Paulinus continues about his own building program:

*10. So I have thus accumulated my sins by bestowing the injustice he sought upon our brother, who was most eager for this burden so that his soul might be lightened by the*

*affliction of his body. For this demand of his, by which he maintained that my buildings in the Lord ought to be made known to you as you had desired to reveal yours to me by inscriptions and paintings, seemed to be truly in keeping with our unity of purpose. So this motive has induced me to interconnect my basilicas with yours not only by their simultaneous construction and the fashion of their dedication, but also by describing them by letter. So in this additional way the fusion of our minds, however remotely we are separated, may be symbolised; and though these buildings, which in the same spirit we have toiled at and erected in the Lord's name, are separated and far distant from each other by a chain of letters.*

*Well then, the basilica, now dedicated in the name of Christ our Lord and God to our common protector and lord of our house, is thronged as an addition to his four basilicas, and is venerable not merely through the respect paid to the blessed Felix but also because of the consecrated relics of apostles and martyrs kept under the altar in the tripartite apse. A vault adorned with mosaics provides light for the apse, the floor and walls of which are faced with marble. These are the verses which describe the scene depicted on the vault:..*

Paulinus shows the normal pride of the builder, not only describing the buildings in situ to the visitors like a tourguide, he also describes them in detail in the letter.

*11. On the girdle below, where an inserted ridge of plaster joins or separates the borders of wall and vault, the following superscription reveals the holy of holies which has been set beneath the altar:*

*Here is reverence, and fostering faith, and Christ's glory; here is the cross, joined with those who witnessed to it. For the tiny splinter from the wood of the cross is a mighty promise. The whole power of the cross lies in this small segment. It was brought to Nola by the gift of holy Melania, this greatest of blessings that has come from Jerusalem. The holy altar conceals a twofold honour to God, for it combines the cross and the ashes of the martyrs. How right it is that the bones of holy men lie with the wood of the cross, so that there is rest on the cross for those who died for it!*

*12. The whole area outside the apse of the basilica extends with high-panelled ceiling and with twin colonnades running straight through an arch on each side. Four chapels within each colonnade, set into the longitudinal sides of the basilica, provide places suitable for those who privately pray or meditate on the Lord's law, and for the funeral monuments of the clergy and their friends so that they may rest in eternal peace. Each chapel is designed on the front of the lintels by a couplet which I have not wanted to quote on this letter. But I have jotted down the lines inscribed on the entrances to the basilica, because*

*if you wished to adopt them they might be suited to the doors of your basilicas. For example:*

*Peace be upon you who enter the sanctuary of Christ God with pure minds and peaceful hearts.*

*Or this, taken from the representation of the Lord over the entrance, the appearance of which the lines describe:*

*Behold the wreathed cross of Christ the Lord, set above the entrance hall. It promises high rewards for grinding toil. If you wish to obtain the crown, take up the cross.*

*The following verses are found at a more private door to the second basilica, where there is what I might call our private entrance from the garden or orchard:*

*Christ's worshippers, take the path to heaven by way of his lovely sward. An approach from bright gardens is fitting, for from here is granted to those who desire in their departure to holy Paradise.*

*This same door is adorned with further lines inside:*

*Each of you that departs from the house of the Lord, after completing your prayers in due order, remove your bodies but remain here in heart.*

Paulinus reveals the layout of the basilica between the lines in such detail that it would be possible to reconstruct it with the extra knowledge of the number of columns and a few major measurements. In comparison to San Clemente, the relics mentioned here relate perfectly to the known evidence for the cult of St. Felix's relics, but we know practically nothing of them in San Clemente before the 9th century. The garden Paulinus mentions is, of course, a monumentalized garden or outdoor space that complements the basilica, as does the *quadriporticus* in Roman churches. The symbolism of paradise and the description of it in the letter underlines the importance of these intermediating spaces in early Christian architecture. The next curious theme in the letter is the orientation of the apse, which "traditionally" would be in the east, but as in San Clemente and many other Roman churches of the time, is not:

*13. The outlook of the basilica is not, after the usual fashion, towards the east, but faces the basilica of the blessed Lord Felix, looking out upon his tomb. But the apse winds round, extending with two sides on the right and left in the spacious area around. One of these is available to the bishop when making his sacrifices of joy, whilst the other takes the praying congregation in its large recess behind the priest. The whole of this basilica opens on to the basilica of our renowned confessor, giving real pleasure to the eye; there*

are three external arches, and the light floods through the lattice by which the buildings and courtyards of the two churches are connected. For because the new church was separated from the older one by the intervening wall of the apse belonging to some tomb, the wall was penetrated on the side of Saint Felix's church by as many doors as the new church has at its front entrance. So the wall is pierced to provide a view from one church into the other, as is indicated by the inscriptions posted between the doors on each side. So these lines are set at the very entrance to the new church:

*This beautiful house lies open for you to enter through the triple arch; this threefold door bears witness to devoted faith.*

14. Again, there are the following inscriptions on either side of that one, beneath crosses painted in red lead:

*The cross on high is circled by a flowery wreath, and is red with the blood which the Lord shed. The doves resting on this divine symbol show that God's kingdom lies open to the simple of heart.*

*With this cross slay us to the world and the world to us, bringing life to our souls by destroying our guilt. If your peace thrives in our hearts made pure, O Christ, you will make us also your pleasing doves.*

15. Within the lattice, which now bridges the short distance previously dividing the adjoining basilicas, over the central arch on the side of the new basilica are inscribed these lines:

*As Jesus our peace has destroyed the dividing barrier, and made us one with Him, sweeping away our divorce by means of the cross, so we see this new building no longer sundered from the old, but joined to it and united by the doors. A fountain gleaming with its attendant water plays between the holy churches, and washes the hands of those who enter with its ministering stream. The people worship Christ in both these churches of Felix, governed by Paul their bishop with apostolic words.*

*The following couplets are inscribed over the other arches which stand on each side. On the one:*

*On eyes bemused a new light dawns. He who stands on the single threshold sees twin churches simultaneously.*

*On the other:*

*Twin churches now lie open by means of three sets of thin arches. Each admires the*

*decoration of the other over threshold which they share.*

*On these arches at the front, facing the basilica of the Lord Felix, these verses are set over the centre:*

*You whose devoted faith constrains you in great crowds to hymn blessed Felix with diverse tongues, stream through the threefold entrance in loose-knit throng. For though you come in thousands, the huge churches will have space for you. Paul the bishop consecrates them for immortal purposes, as they stand close joined to each other by means of the open arches.*

*On the other arches are these two couplets:*

*You who have left the old church of holy Felix, now pass to his new abode.*

*That single faith which worships One under three names receives with its triple entrance those of single mind.*

*16. The following lines are inscribed in the two sacristies which, as I mentioned, enclose the apse on each side. They describe the purposes of each of them. To the right of the apse we read:*

*This is the place where the sacred food is stored; from here is brought forth the nourishing repast of the holy service.*

*And on the left of the apse:*

*If a person decides piously to meditate upon the Law, he will be able to sit here and concentrate upon the holy books.*

The humble beginning of the letter vanishes and these lines show Paulinus' pure pride and joy in his achievements as he directs the congregation and visitors to marvel at his architecture. The impression we get as readers is the very open and flowing space between the different liturgical spaces within the basilica and between the different buildings. This can also be seen in the reconstructions of Chapter 4.2 and in the previous description of the civic basilica, which flows openly from its long side to the forum. This also applies to the interior of the Roman *domus*. The very open and linear set of spaces from the *fauces* to the *atrium* to the *tablinium* through the peristyle up to the *exedra* can also indicate the Romans' dislike of doors and barriers or their fondness for open vistas. The previously described set of spaces is, of course, ideal, and this rarely can be found in archaeological evidence and has thus been questioned. However, it is plausible when considering the relationship of the *tituli* and their probably preceding function as a *domus* and their

influence on the layout of early Christian basilicas in Rome.

Paulinus finishes his description of the basilica in Nola and continues with his other building project in Fundi:

*17. Let us now leave this basilica at Nola and pass to that at Fundi, a town equally dear to me whilst I had property there, which was then more frequently visited by me. So I had longed to found a basilica there as a pledge of my affection as a resident or to commemorate my former estate there; for the town was in need of a new one, since the existing church was tumbledown and small. So I thought I should append here these modest verses which I have composed for the dedication of that basilica at Fundi; for building is still in progress, but it is almost ready to be consecrated if God be kind.*

*The reason chiefly impelling me to send these verses is that my Victor liked the painting which is to be visible in the apse of the church, and he desired to convey the poems to you in case you wished to depict one or other of them in your newer basilica, which Victor says also incorporates an apse. (You must decide whether I should say absida here abside; I confess my ignorance, for I don't remember ever reading this latter form of the word.)*

*This little basilica of Fundi also will be consecrated by sacred ashes from the blessed remains of apostles and martyrs, in the name of Christ the Saint of saints, the Martyr of martyrs, the Lord of lords. ...*

This is an important document and proof of the importance of the Roman patricians in the big building boom of fifth century Central Italy. Paulinus, known as a wealthy patron, mentions his landed property in another passage and sees as his responsibility to provide his serfs a proper church which he can obviously afford. This also relates to the *tituli* in Rome, where private sponsorship or self-financed autonomous building was crucial during the end of the fourth and the beginning of the fifth century.

In the same chapter, Paulinus adds a crucial detail for the reconstructions of Chapter 4.2:

*...These are the verses on the relics:*

*Under the lighted altar, a royal slab of purple marble covers the bones of holy men.*

In *Carmen 27*, Paulinus again describes his new church. The coffered ceilings are mentioned again and the rich marble decorations. He also describes the murals in the basilica with themes from the Old Testament and their symbolism. In *Carmen 28* and *19* the coffered ceilings are mentioned again. In all, these passages by Paulinus are a rare

insight into an early Christian interior and into how these patrons viewed the architecture's and decoration's symbolism. They have been considered in Chapter 4 as comparative evidence for the reconstructions.<sup>230</sup>

Sidonius Apollinaris gives this description of St. Justus in Lyon (destroyed in 1562) built by Bishop Patiens: *All you who here admire the work of Patiens, our bishop and father, may you be effectual supplication obtain the boon you ask for! The lofty temple sparkles and does not incline to right or left, but with its towering front faces the sunrise of the equinox. Within it the light flashes and the sunshine is so tempted to the gilded ceiling that it travels over the tawny metal, matching its hue. Marble diversified by various shining tints pervades the vaulting, the floor, the windows; forming designs of diverse colour, a verdant grass-green encrustation brings winding lines of sapphire-hued stones over the leek-green glass. Attached to this edifice is a triple colonnade rising proudly on columns of the marble of Aquitania. A second colonnade on the same plan closes the atrium at the farther end, and a stone forest clothes the middle area with columns standing well apart. On one side is the noisy high-road, on the other the echoing Arar; on the first the traveller on foot or on horse and the drivers of creaking carriages turn round; on the other, the company of the bargemen, their backs bent to their work, raise a boatmen's shout to Christ, and the banks echo their alleluia. Sing, traveller, thus; sing, boatman, thus; for towards this place all should make their way, since through it runs the road which leads to salvation.*<sup>231</sup> Like Paulinus Nolanus, Sidonius also wrote dedications to churches. As in the previous *laudatio*, the poem for St. Martin's shrine also praises its gold, silver and precious stones that can be compared to Solomon's temple.<sup>232</sup>

As Ann Marie Yasin notes, the free flowing space of the complex in Cimitile was of the utmost importance to Paulinus. The preceding buildings with the addition Paulinus' work was unified into a complex with subtle porticoed boundaries between each building. The pilgrimage within the complex was guided by Paulinus' verses in mosaic, guiding and

---

<sup>230</sup> See Appendix for the full text.

<sup>231</sup> Sid. Apoll. *Epist.* 2.10,4: *Quisquis pontificis patrisque nostri/conlaudat Patientis hic laborem/voti compote supplicatione/concessum experiare quod rogabis. aedis celsa nitet nec in sinistrum/aut dextrum trahitur, sed arce frontis/ortum prospicit aequinoctialem. intus lux micat atque bratteatum/sol sic sollicitatur ad lacunar, fulvo ut concolor erret in metallo. distinctum vario nitore marmor/percurrit cameram solum fenestras, ac sub versicoloribus figuris/vernans herbida crusta sapphiratos/flectit per prasinum vitrum lapillos. huic est porticus applicata triplex/fulmentis Aquitanicis superba, ad cuius specimen remotiora/claudent atria porticus secundae, at campum medium procul locatas/vestit saxea silva per columnas. hinc agger sonat, hinc Arar resultat, hinc sese pedes atque eques reflectit/stridentum et moderator essedorum, curvorum hinc chorus helciariorum/responsantibus alleluia ripis/ad Christum levat amnicum celeuma. sic, sic psallite, nauta vel viator; manque iste est locus omnibus petendus, omnes quo via ducit ad salutem.*

<sup>232</sup> Sid. Apoll. *Epist.* 4.28,5.

instructing the pilgrim.<sup>233</sup> Peter Brown compares this patrician family affair-like building of the complex with a late antique villa in the countryside as would be suitable for a man of Paulinus' pedigree.<sup>234</sup>

For these descriptions of marble, gold and porticoes, we will find a kinship in Chapter 3.2 concerning the *domus*. This is also important in creating the more hypothetical reconstructions in Chapter 4.2. The architect's jargon of "flowing space" also becomes evident in the Roman 5th century *Sakraltopographie* with the *polifora* opening to the *quadriporticus* and the nave.

The similarities between Paulinus and Sidonius are great. Both were members of the clergy as well as wealthy property owners from Roman Gaul and were very enthusiastic in describing their building programs. We do not know how they lived themselves, but their churches are known from archaeological investigations. Their villas and style of living can be sensed from their letters and it is easy to relate to the comparative archaeological evidence. Sidonius even mentions Vitruvius' work in his letters, so we can assume that Vitruvius' remarks on basilicas were known among the late antique patrons of buildings.

---

<sup>233</sup> Yasin 2010, 185-188.

<sup>234</sup> Brown 2012, 228.





Fig. 2.3.01. The basilical complex in Nola.



Fig. 2.3.02. The shrine of Felix inside Paulinus' basilical complex.

## 2.4 Other evidence concerning the appearance of early Christian basilicas

In this chapter, I briefly deal with the detailing of an early Christian basilical interior according to the sources. This relates to Chapter 4 and its more hypothetical reconstructions (Xb and Xc). This is not even close to a full summary of the sources, but just to make the point that it is also possible to reconstruct quite a detailed picture of the interior according to the literary (and archaeological) evidence. The testamentary dispositions to the churches give us clues, but the more important endowments of landed property shall also be discussed in Chapters 3.1, 3.2 and 3.3.

In a legal document, preserved in a 12th century copy in the Vatican, a wealthy army official Flavius Valila (also known as Theodorus) donates to a church in Tivoli a group of estates, silver and books. This list also includes:

*...and for archways 2 pure silk curtains, white with gold edging; 2 purple curtains with gold edging; 2 pure silk curtains, white with gold edging embroidered with feathers; 2 curtains woven from silk, green and purple; 2 curtains woven from silk, white and purple; 2 pure silk curtains, scarlet and green (a further 58 curtains of silk or linen for various parts of the church).*<sup>235</sup>

Since this is not the only document mentioning textiles, it can be assumed that the curtains played an important role in the inner arrangements of a basilica. The inventory from a small village church in Egypt lists: *...curtains 2, iron rod (probably to hang the curtain in an archway?), .....; door curtains 6, old one of the same 1,...*<sup>236</sup> The woven decorative motifs are not well known. At the end of the fourth century, Epiphanius of Salamis tore down a curtain with a picture of Christ or some saint in a church porch in Palestine.<sup>237</sup> There are still remains of liturgical textiles, mainly from North Africa where the dry climate has helped to preserve these easily perishable objects of art.<sup>238</sup>

The importance of textiles has been rediscovered during the last decades. As Annemarie Stauffer states: *Scholars have begun to realize, however, that large wall hangings and curtains occupied an important place in the houses of the rich and presumably also in official buildings. They were bought and hung not as single pieces, but in sets.*<sup>239</sup> The best

<sup>235</sup> Lee 2000, 232. The document is dated the 17th of April 471.

<sup>236</sup> Lee 2000, 233-234.

<sup>237</sup> Chadwick 1993, 281.

<sup>238</sup> Weitzmann 1979, 433-436, 460-462, 532-536, 549-550. Susan A. Boyd suspects that these textiles might have hung on walls in place of frescoes.

<sup>239</sup> Stauffer 1995, 10; Schrenk 1999, 74-110 for possible models of late antique wall hangings.

known example of curtains hanging between the columns is the mosaic in Sant'Apollinare in Ravenna (Fig. 2.4.01.)

In general, the Louvre's late antique collections of textiles are among the best in the world. The collections also include several important mosaics relating to this dissertation. The three mosaics from the Eastern Mediterranean depicting basilicas and their interiors (Ma 3677, Fig. 2.4.02.; Ma 3676, Fig. 2.4.03. and Ma 5093, Fig. 2.4.04.) provide definitive proof for curtains used in basilicas. The first two give impressions of basilicas in quasi-perspective with hangings covering their doors and window openings.

The third one (Ma 5093) depicts a church interior with an altar, columns and a choir with a gate. Between the columns are curtains hanging and tied back showing a view of the altar with a cross. The background consists of a typical presentation of paradise with its flora and fauna. The text in Greek says: "Christ, open the doors."

There is no material evidence of curtains in Rome from the late antique period except in art (Fig. 2.4.05.). One of the most important sites with archaeological evidence for the use of tapestries in a Christian context is the previously mentioned 5th century Southern Basilica of Bawit in Egypt (Introduction). The vast amount of archaeological finds also included several hangings, one of them depicting St. George slaying the dragon (Fig. 2.4.06.). In general, the archaeological evidence of liturgical furnishings from Egypt is the largest (Fig. 2.4.07.-2.4.11.).

The interesting part is that presentations of curtains in manuscripts, mosaics and engravings is that they are always drawn back to show what they could hide. If curtains were used, I would suggest that they were used both ways in the early Christian Church: both to hide or to reveal - depending on the situation and the liturgical mystery in question.

There is a plenty of artistic evidence for Late Antique interiors. The frescoes in an oratory in Titulus Pammachii show a scene of a martyr surrounded by worshippers on their knees. The martyr is framed by curtains. The hanging curtains between the columns can be found in mosaics and manuscripts. The famous portrait of Constantius II (337-361) shows the emperor sitting on a throne throwing coins to *plebs*. The miniature is framed with two columns with decorated curtains between them.<sup>240</sup> The most famous presentation of hanging curtains in a portico is the clerestory mosaic in Sant'Apollinare Nuovo (beginning of the 6th century). The mosaic on the wall depicts the palace of Theoderic. The palace's open arcades are partially covered by decorated curtains hanging possibly from iron rods attached to the columns. Similar scenes are also depicted in the early Christian mosaics of North Africa. The Tebessa mosaics are the most well known

---

<sup>240</sup> Calender 354, Part 7 (consular portraits of the emperors).

but there are also other mosaics that depict the exterior of basilicas with curtained porticos and windows. In Peter Brown's theory the donor of curtains like these for the churches would be noblewomen such as Melania the Younger.<sup>241</sup>

The sheer number of curtained porticos in early Christian art, ranging from mosaics to manuscripts, in my opinion, leaves no other alternative than that curtains were a relevant feature of the early Christian interior. The extent early Christian spaces, such as Santa Sabina on the Aventine, would yield a totally different impression indeed if curtained. The gifts from the emperor were gold and silver chandeliers and other decorations. There were also rich mosaics. The large window surfaces and the bright light on the decorations must have made a great impression on the visitor. The *Liber Pontificalis* gives detailed lists of all the donations by Constantine, and even though the historical accuracy of the biographical narratives is disputed (the *Liber Pontificalis* was first compiled at the beginning of the sixth century), the lists of donations are widely trusted.<sup>242</sup> In the life of Pope Silvester (314-335), there is a list of Constantine's donations of tons of silver and estates to keep the Lateran basilica running.<sup>243</sup>

The silverware and silken robes donated by Melania, for example, were the votive kind of endowments that were not *immobiliare*.<sup>244</sup>

This argument is made in Drawing Xc showing San Clemente with curtains that are more closely discussed in Chapter 4.2. For this reason and since there are no reconstructions of early Christian spaces with curtains, I have also produced Drawing Xc to demonstrate the obvious effect on the interior.

---

<sup>241</sup> Brown 2014, fig. 16.

<sup>242</sup> Lee 2000, 228.

<sup>243</sup> LP 34.

<sup>244</sup> Brown 2014, 300.



Fig. 2.4.01. The Palace of Theoderic in the clerestory mosaic of Sant'Apollinaire Nuovo in Ravenna. The mosaic presents the combination of columns and curtains - the interior element that has been largely ignored in studies of late antique churches.

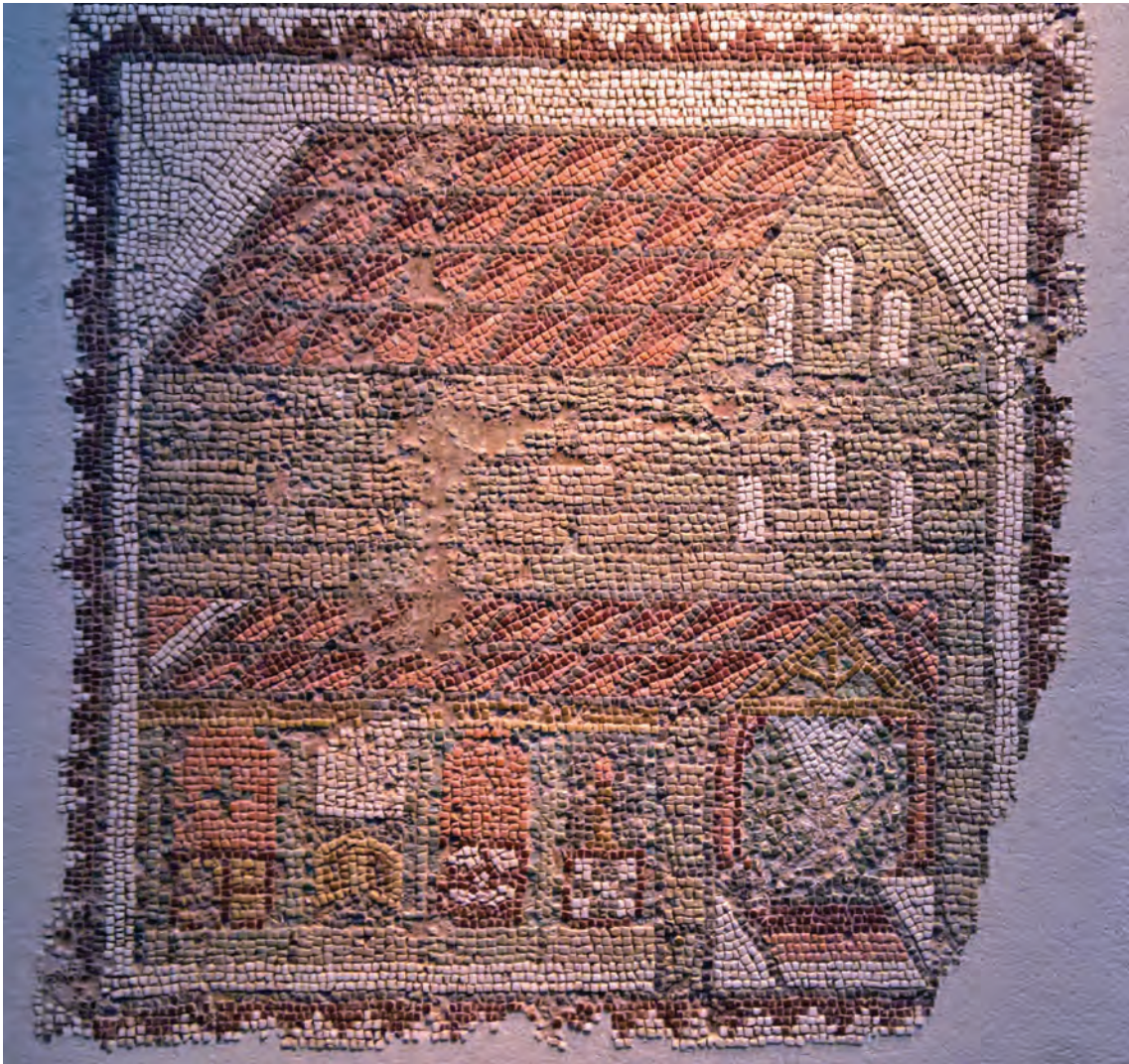


Fig. 2.4.02. A Libyan 5th century church mosaic depicting a church with curtains. Louvre Ma 3677.



Fig. 2.4.03. A Libyan 5th century church mosaic depicting a church with curtains. Louvre Ma 3676. As with Ma 3677 (Fig. 2.4.02) the mosaic depicts curtains that are tied back to provide access. The interesting factor is that they are used in doorways. This late antique evidence could also relate to the discussion of open and closed spaces in the Roman *domus*. The emphasis has been on the findings of hinges, etc. disregarding the fact that curtains might provide the answer. Unfortunately, the Italian climate and soil leave no traces of the curtains buried in Pompeii or Herculaneum.



Fig. 2.4.04. A Libyan 5th century church mosaic depicting a church interior and altar with curtains. Louvre Ma 5093.



Fig. 2.4.05. Santa Maria Antiqua in Rome. The 6th century frescoes depict tapestries used as decoration. Another similar example can be found in San Marco by Piazza Venezia in Rome.



Fig. 2.4.06. An early Christian curtain found by the French in the Baouit monastery in Egypt. The embroidered curtain depicts four women and the slaying of the dragon. Louvre E 26794.



Fig. 2.4.07. An Egyptian border for a tapestry from the 5th or 6th century depicting a grapevine. Museum für Byzantinische Kunst, Staatliche Museen zu Berlin, Inv. 9067.





Fig. 2.4.08. A 5th or 6th century tapestry from Antinopolis, Egypt. Louvre E 29275 and E 29278.

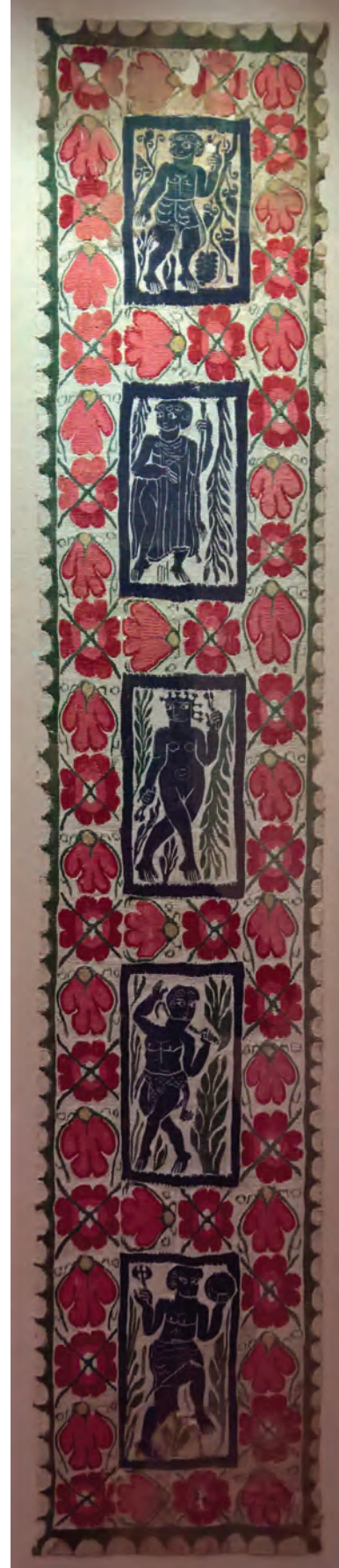


Fig. 2.4.09. A tapestry from Egypt depicting bacchanalia. Louvre AF 5511.



Fig. 2.4.10. A selection of Coptic bronze church furnishings. The liturgical furnishings, such as candelabra, incense burners etc. are limited in the finds from Rome. However, it can be assumed, that these Coptic finds bear at least some resemblance to the Roman liturgical furnishings.



Fig. 2.4.11. A selection of Coptic bronze church furnishings. Reverse of Fig. 2.4.10.

## 2.5 The Roman Basilica in its Urban Context

Since the urban context is vital for the buildings, as has been discussed in Chapter 2.1, it will be important to do the same here.

As Hugo Brandenburg has pointed out, the Roman 4th century urban project was about continuous urban self-renewal. The church building was preceded by the luxurious Severan *domus* which had, in turn, changed the urban fabric by possibly replacing the overpopulated *insulae*.<sup>245</sup> The 5th century did not face the same problems as the Constantinian period. The plausible reason for church building spreading from the outskirts to the center could be the patrons, real estate portfolios and not the bishops' fear of demons or aim to placate the pagan aristocracy<sup>246</sup>. This concentration of churches in areas rich with *domus* could also relate to Rome's real estate markets, where even the rich would rent their *domus*.<sup>247</sup> This would be close to the same thing as in European big cities in the 19th century where it was common for the top tiers of society to rent.

The changes in Rome's urban structure has been researched by Letizia Pani Ermini. Especially the influence of episcopal building projects slowly moved the administrative center of Rome to the outskirts of the city, namely the neighborhoods of the Lateran basilica and St Peter's. However, this process was slow, starting during the 5th century and after the building of the new Leonine walls of the Vatican, the Forum Romanum was close to deserted. The great earthquake of 847 hastened the process.<sup>248</sup>

The 5th century focus of this work is about the smaller churches in Rome. The diminishing scale from the Constantinian period to early medieval is apparent. This can be explained by various reasons: the sharp drop of population, the senatorial unwillingness to finance or the sheer lack of money<sup>249</sup>. However, as the Roman elite's focus on gift economy turned away from public works and civic structures such as baths, gates and theaters, they found a new direction in church buildings, monasteries and *xenodochia*.<sup>250</sup>

The Roman churches (Table IV<sup>251</sup>) that were built around the same time as San Clemente (4th quarter of the 4th century to 1st quarter of the 5th century, roughly from Damasus I to Sixtus III) are: Sant'Anastasia al Palatino, San Lorenzo in Damaso, San Lorenzo in Lucina, Santa Maria in Trastevere, Santa Pudenziana, San Saba, San Sebastiano fuori le

---

<sup>245</sup> Brandenburg 2004, 250.

<sup>246</sup> Salzman 1999, 127-130.

<sup>247</sup> Purcell 1999, 151.

<sup>248</sup> Ermini 2001, 255-323; Ermini 2000, 15-39.

<sup>249</sup> Ward-Perkins 2002, 58-61.

<sup>250</sup> Yasin 2010, 109.

<sup>251</sup> Table IV is based mainly on CBCR, LTUR and Pensabene 2015.

mura, Santa Susanna, San Clemente, Sant'Ermete, San Marcello al Corso, Santi Nereo e Achilleo sulla Via Ardentina, San Paolo fuori le mura, Santa Prassede A (?), San Sisto Vecchio, Santa Balbina, Santi Bonifacio e Alessio, San Caio in Via Porta Pia, Santa Cecilia in Trastevere, San Ciriaco, Sant'Eusebio, Santi Giovanni e Paolo, San Matteo in Merulana, Santa Prisca and San Vitale.

## 2.6 Conclusion

As in the typology, created for this purpose according to the description of method presented in the Introduction, San Clemente's attributes are in harmony with those of the other contemporary basilicas (Table I). When San Clemente is compared to the basilicas of antiquity, the differences are naturally great. However, there are common characteristics: the nave, the aisles and the clerestory walls. The function of the building was, of course, different. Even though some of the basilicas outside Rome were used for the imperial cult, the basilicas mostly had functions we would consider civic. The basilicas of the Republican era were built and financed by the senate to impress their contemporaries and to ensure that their name would be remembered long after they were gone. This attitude to public building is best portrayed by Louis XIV's minister of finance Jean-Baptiste Colbert (1691-1683) who preferred magnificent buildings over wars to make his king be remembered forever. This tactic was later used by all French presidents.

The end of the Republic did not change this situation –the emperor or his family became the donors instead. In both cases, these patrons succeeded in their objectives – such as Paulinus Nolanus, who is unable to hide his pride in his building project in Nola in Epistle 32 to Severus.<sup>252</sup>

When Constantine came to power, the public works financed by the emperor started to decline - only to be replaced by the projects for Christian basilicas and suburban mausolea. Private sponsorship also continued, as we found out in the cases of Paulinus Nolanus, Vestina and Demetrias (Chapter 2.3 and Chapter 3.3). In this sense in general, there was no change in the production of the building type. We do not know who financed San Clemente, but it is probable that private money was also included, as with the other basilicas of this time. At the same time, highly powerful and wealthy bishops financed the building of Santa Sabina, Santa Maria Maggiore and San Vitale.

The approach to San Clemente was also different from the civic basilicas. Entrance through the short end, as a linear approach to the inner sanctuary, compared to the outline from the long side in the secular basilicas, is very different (as shown in Table II). The

---

<sup>252</sup> See Appendix I for the full letter.

feeling of space changes immediately from centered space to linear space, as the function also changes. The “Pompeian” basilicas and the Basilica of Maxentius can be seen in many senses as exceptions.

The apse as a new feature introduced in the first century was reserved during that time for statues of emperors and the like. In San Clemente and in the other Christian basilicas, the apse becomes a similar focal point of the building. This can be traced to the late antique *domus*. The ambulatory basilicas of the fourth century are in many ways a hybrid between the Basilica Ulpia, Leptis Magna etc. and the basilicas of the fifth century. Both types were also manifestations of imperial power.

The previously discussed theory of curtained naves also changes the inner space of a basilica. The written evidence for the Basilica Iulia and the like, with vivid descriptions of legal disputes etc. and, for example, Vitruvius’ description of required privacy for the merchants, gives an impression of the use of the internal space of an antique basilica that differs completely from the idea of a nave curtained and closed for the duration of the Holy Eucharist. This would mean that the Christian basilica, which was already a more closed entity compared to the secular basilica, would have varying levels of openness for the congregation (Drawing Xc).

Another interesting feature is the measurements of a basilica laid out by Vitruvius. None of the basilicas of antiquity, with Basilica Ulpia among the few exceptions, appear to follow the rule of Vitruvius’ proportion of the nave’s length to its height. When the usual ratio is lower than 0.70, the Christian basilica comes in general to 0.85 (San Clemente 1.13). The proportion of nave width to nave length is closer to the Vitruvian ideal of 2.0 in Christian basilicas (San Clemente 2.35). This probably does not tell us anything other than that Vitruvius did not describe real contemporary buildings. It seems certain, however, that the height of the nave in Christian basilicas rose compared to secular ones, a development already seen in the basilicas of the second and third centuries. This was probably due to the change in the functions of the basilicas. San Clemente was smaller than the basilicas of the fourth century. The need to build major basilicas was probably accomplished, and bishops and patricians started to build basilicas for congregations of a more modest size. Similarly, multiple aisles and transepts appear not to have been necessary since they almost completely disappear during the fifth century. In many ways, San Clemente represents the “prototype” of a basilica during the fifth century. The lack of a *quadriporticus* in basilicas like Santa Sabina can also be explained by the circumstances. During the first half of the fifth century, Rome was still densely populated, and there was lack of space for big building projects – a problem also faced by the early emperors. The *quadriporticus* naturally required much space (and financing) and was probably, in some

cases, impossible to fit onto the site. In some cases, like Santa Agata dei Goti, the atrium was of a very modest size, as if built in spite of the lack of space, simply because it was required by the ideal model. Whether or not the preceding *aula* at San Clemente had a peristyle remains to be discussed (Drawing XII).

As Tables I and II show, the entrance side changes immediately when the function changes. There are, of course, some exceptions to this rule in the Mediterranean world, but in general, this is the case. In many ways (Table II), Groups 1A and 1B are too similar to be separated. The line of development is very clear. Basilicas like San Clemente remained the most common type of a basilica in the West, until Charlemagne built a transept in his copy of St. Peter's in the ninth century, and the model of a basilica with a transept became the norm.

The changes to basilicas caused by the change in function from secular to religious were perhaps not clear to their builders. The very classicizing features of Santa Maria Maggiore (architraves with acanthus-mosaics) yield the impression of a patron with a very classical upbringing, and this is, of course, true – the wealthy Christian patrons of Rome were the upper classes. One of the features of San Clemente, the open *narthex* or *polifora*, as in San Vitale, bears some resemblance to the Republican basilicas or late antique *domus* in its openness (Drawing IX). This feature was not repeated after the fifth century.

The area in which San Clemente was built, dealt with above, was an amusement park of a kind. As many other churches of Rome, San Clemente was situated on the outskirts of the city. St. Peter's and San Paolo fuori le mura were outside the walls and the later basilicas still remained far away from the Forum Romanum until the sixth century. The majority of Christians at this time were of the lower classes. The senatorial class still retained their old status and only very slowly converted from pagan traditions to the new religion. During Constantine's time, it was not politically savvy to build churches right in the faces of the ruling class and the change took some 200 years, but probably not for the reasons of "demons", as previously discussed by Peter Brown.

As seen on Maps III and IV, the results can also be reversed. The maps seem to also highlight the "fashionable" residential areas of late antique Rome (Regio V and VI), where the fifth century basilicas were built on top of large *domus*. This feature and relationship is very often mentioned in the research literature but not shown as accurately as on Maps III and IV.

The location of the civic basilicas is clear: they were in the middle of the area of politics and commerce. Due to the political (and financial) situation, a Christian basilica, like San Clemente, was further away from the city center. The location of San Clemente (as on

Drawing V) reveals an interesting point to consider. The games still went on, the arenas attracted people to the site, and it was a wise decision to place a church in the middle of the action. In fact, the Colosseum was surrounded by more churches, namely Santi Giovanni e Paolo and San Pietro in Vincoli. San Clemente was also situated along an important main artery of the city – the Via Labicana. While the civic basilicas often were located at the Forum Romanum in the midst of the city, the Christian basilicas were placed outside the center. An obvious example of this choice are the ambulatory basilicas by the main highways outside the walls, very clearly visible to people approaching the city. The explanation would seem to be who owned the land. The emperor had the imperial *patrimonium* and the elite had their own real estate that would dictate the spreading of the churches in the fourth and fifth centuries.

The approach to San Clemente from the street rose a couple of steps up to the colonnaded *quadriporticus* and through the open narthex to the nave. In the case of the Lateran basilica, the middle door was reserved for the bishop. The linear approach is clear, however: through the *quadriporticus* and *narthex* or *polifora* to the nave, where at the end was the apse with mosaics. In civic basilicas, the most common entry was from the long side (not the case in Pompeii). The long side, as Vitruvius also described, was integrated with the busy forum and in many ways, like at the Forum Romanum, the basilicas were an inseparable part and continuation of the forum itself. San Clemente, like other fourth and fifth century basilicas, was closed to everyday life and to its surroundings. San Clemente and its peers with the open *narthex* would be closer to the *domus*. In a closed complex separated from the street, the free-flowing space between the *quadriporticus*/peristyle, *narthex* and the nave/*aula* are obvious. Moreover, the reason is clear – the function of the basilica had changed from a multipurpose building to an ecclesiastic building of a new religion.

### 3 The late antique *domus* and the *titulus*

In this Chapter, I present a contemporary comparative urban context concerning San Clemente at the beginning of the fifth century. At the same time, with this comparative evidence, I present the development of the late antique *domus*, the *Mithraeum* and the *titulus*. This is relevant for Chapter 4 for the building history of San Clemente or how the site of San Clemente transformed from the third century Phase IV (possibly via Phase IVb) to Phase V in the Chapter 4.2 reconstruction of an early Christian basilica.

To achieve this, I have created maps showing the previously mentioned building types within the Roman late antique urban structure in Table IV with all the archaeologically known churches of Rome from the first quarter of the fourth century down to the second quarter of the sixth century. Table IV correlates with Map IV and includes the interrelating information on the *domus*, *Mithraeum* and *titulus*. This will be in cross-reference with Table III (the list of Roman *domus* known to have been in use at least during the fourth century and which are known by name and archaeological (structural, not by *fistulae* or stamps of ownership on lead water pipes alone) evidence and Map III.

Maps III and IV show Rome with its main public buildings which have been collected from FUR and further research. The topographical data (the contours) was provided by the *Digital Augustan Rome*-project of the University of Pennsylvania Museum of Archaeology and Anthropology.

I also present a rough reconstruction of building Phases II and V along with a highly speculative reconstruction of Phase IVb (Chapter 1.2).



### 3.1 The late antique *domus*

Recently, the existence of public and private spheres have been dominant themes in the study of the *domus*. The discussion often concentrates around the Pompeian and Herculanean *domus* which, of course, is an earlier period of this subject. However, the main theme remains: How public or private was the Roman house? It now seems evident that the Roman magistrates performed many of their public duties at home, especially when it came to juridical cases. The religious duties of the *pater familias* were also performed in the house, where the *fauces*, *atrium*, *cubiculum* and peristyle were part of the machinery of public duties.<sup>253</sup> A relook at the material is necessary, as Kim Bowes has pointed out.<sup>254</sup> The marginality of late antique *domus* studies has also been evident in Rome, as Federico Guidobaldi stated in 1999 referring to the situation of the mid 1980s. There are around 200 known *domus* in Rome according to archaeological evidence (LTUR) from the Severan period to the 6th century.<sup>255</sup>

The close connection of the *domus* as a communication point among the Roman aristocracy has been discussed by Steffen Diefenbach.<sup>256</sup> This aristocratic communication will be examined more closely in Chapter 3.2 in the context of Macrobius' *Saturnalia*. This is merely to point out that if the 5th century churches and *domus*' are located in the same areas as on Maps III and IV, this aristocratic communication and the location of the churches has a correlation.

A *domus* within the Aurelian Wall is a relatively rare feature in archaeological finds compared to the amount of public building. Starting from the second century, the Roman aristocracy favored power bases in the countryside. Residences within the walls were used when performing public duties and for business. The intervening public and private spheres of the Roman *domus* are already well known from literature and the archaeological evidence from Pompeii and Herculaneum, but the archaeological evidence for the *domus* in Rome is relatively scarce. Richard Krautheimer was among the first to make the point of Roman early Christian Church architecture's debt to the Late Antique *domus* and villa architecture.<sup>257</sup> Hugo Brandenburg has also discussed how the *domus* influenced early

---

<sup>253</sup> Tuori 2015.

<sup>254</sup> Bowes 2008, 85-99.

<sup>255</sup> Guidobaldi 1999, 53-55.

<sup>256</sup> Diefenbach 2007, 385-387. A recent disagreeing view by E. Adams, *The Earliest Christian Meeting Places - Almost Exclusively Houses?*, Bloomsbury T&T Clark 2013. Adams studies, according to available literary and archaeological evidence, commercial and public spaces as places for gatherings.

<sup>257</sup> Krautheimer 2003. In *Wege und Irrwege im Spätantiken Kirchenbau* (1980), in *Europäische Kunstgeschichte*, 109-131. Krautheimer's remarks in a nutshell are about the same theme of the *flowing space* in the 5th century as I have discussed, although, not in the same architectural terms.

Christian architecture considerably.<sup>258</sup> The overlapping architecture is interesting in the sense of how much an early Christian church reflected the previous domestic architecture that it replaced.

Architecturally, the Late Antique *domus* has changed relatively little compared to the Pompeian *domus* of the early Imperial period. A common feature between the Late Antique *domus* and the early Christian Roman basilica is the *polifora*. As in the *domus* of the Fortuna Annonaria in Ostia or San Clemente (also in Santi Giovanni e Paolo, San Vitale, San Pietro in Vincoli, San Sisto Vecchio, San Lorenzo in Damaso and Santa Pudenziana), the free-flowing space is emphasized by a colonnade rather than several doorways. As discussed by Federico Guidobaldi and Olof Brandt, this could also be an architectural link between the *domus* and the church. Why this feature lasted only for the first half of the fifth century has not been resolved as, Olof Brandt states.<sup>259</sup> However, architecturally the late antique *domus*' relation between peristyle and *aula* through a *polifora* is the same as the early Christian church's relation between the nave and *quadriporticus* through the open *narthex/polifora*. Drawing IX shows this similarity quite clearly. This similar *polifora* arrangement can be found in San Clemente, San Sisto Vecchio, Santi Giovanni e Paolo, San Pietro in Vincoli and San Vitale.<sup>260</sup>

The openness of the late antique *domus* has also been discussed at length by Simon Ellis and Isabella Baldini Lippolis.<sup>261</sup> The open vistas of the *domus* terminating at the apse were, however, to delight as much as to overawe the visitor. As Kim Bowes has creatively paraphrased Le Corbusier (*Houses are machines for living*), the late antique *domus* and villa were "*Machines for competing*" with peers.<sup>262</sup>

The traditional 19th century theory of a *domus*' atrium or peristyle acting as an early Christian place of congregation is dubious since the practitioners of the faith up to fourth century were not wealthy senators or aristocrats rich enough to own a *domus* that could accommodate even a small gathering.<sup>263</sup> A more plausible explanation could be that the Constantine era ruling classes became Christian and the congregations met in their private quarters, like with the Mithraic cult, and later on, this arrangement was, during the fifth century, turned into a working architectural model in Rome, combining the basilica

---

<sup>258</sup> Brandenburg 2004, 249-256.

<sup>259</sup> Brandt 2014, 40-45; Guidobaldi 1992, IV, 1, 152-154.

<sup>260</sup> Geertman 1968-1969, 224.

<sup>261</sup> Lippolis 2005, 39-50. Simon Ellis 2000, *Roman housing*, London.

<sup>262</sup> Bowes 2012, 95.

<sup>263</sup> Walter Lowrie, *Monuments of the Early Church*, New York 1901. Heinrich Holtzinger, *Die altchristliche Architektur in systematischer Darstellung*, Stuttgart 1899. There are several other studies which support the traditional Roman *domus* as the beginning of Christian architecture. However, they have been largely discarded several decades ago. Except by some church historians. See White 1990, 14-15.

with a *peristyle/quadriporticus*. This would, in my opinion, mean that the fifth century ecclesiastical architecture was partly reminiscent of the fourth century *titulus* architecture based on a *domus*.

Unfortunately, archaeological evidence for the Roman *domus* is scarce. There are no complete or reconstructable houses to study as complete as those in Pompeii or Herculaneum. The problem with Pompeii and Herculaneum is the late Republican or early Imperial date. However, the large *domus* can be found from Pompeii also, like the Casa del Fauno (Fig. 3.1.01.) In Ostia, the comparisons are better, even though provincial in scale, as in Pompeii. The house of the Fortuna Annonaria (Drawing XXIV, Fig. 3.1.04. and 3.1.05.), Dei Protiro (Fig. 3.1.06.), Amor and Psyche, Domus dell'Opus Sectile (Fig. 3.1.07.), or Dioscuri show the new features of the late antique *domus* on a smaller scale.<sup>264</sup> The more refined remaining *domus* can be found in other parts of the Roman Empire. The rich *domus* of Ephesus are relatively well preserved. The new architectural feature of the *aula* adjoining the other reception spaces is visible in many of the houses. These same features with the apses and niches might have been part of the architectural vocabulary of the original Lateran palace.<sup>265</sup>

The overall majority of the *domus* listed in LTUR located in these three Regiones (Regio, II, V and VI) can also be explained by the large urban renewal (rapid excavations and thus poorly documented) of the 19th century, but the other reason is, of course, the very public nature of Regiones IV and VIII-X, where nearly all the Republican *domus* had been replaced by public buildings. For comparison, the famous *Curiosum Urbis Regionum XIV* and *Notitia Regionum Urbis XIV* give a completely different picture and this dissertation does not go into a long debate over their accuracy in listing its buildings.<sup>266</sup> However, both lists include the main public buildings in Regio III. The obvious reason, in my opinion, are the contours of topography for the relatively high distribution in Regiones II, V and VI. The ground is relatively flat and thus easier and cheaper to build on. These Regiones were also fashionable during the late Imperial period since the larger and well-known *horti* are also there and the higher plateau must have been (as it is also today) much more pleasant during the warmer seasons.

The Domus of Iunius Bassus (Regio, V, beginning of the fourth century) is one of the well-known late antique *domus*. Iunius Bassus was the *consul ordinarius* of 331 and the *domus* is more well known for its basilical hall (finally destroyed in 1930).

The basilica can be found as early as in the Domus Flavia (1st century AD, Drawing

<sup>264</sup> Meiggs 1973, 252-262.

<sup>265</sup> Lippolis 2005, 14-19, 127-130.

<sup>266</sup> For example, the number of 44000 *insulae* and its meaning has been much debated.

XXII, Fig. 3.1.02.). An interesting feature of the Domus Iunius Bassus is also that the *domus*' basilica was converted into the church of Sant'Andrea Catabarbara (during the pontificate of Pope Simplicius, 468-483.<sup>267</sup> This also applies to Santi Quirico e Giulitta, Santa Balbina and Santi Quattro Coronati. Iunius Bassus died while holding the prefecture of the city. According to contemporary testimonies, he was widely mourned but not as a recently converted Christian but as the prefect. The Domus of Iunius Bassus was donated as an endowment by Flavius Valila Theodosius century later. The motive for the will might have also been the need to secure the protection of the church in a time of violent regime change.<sup>268</sup>

The previously mentioned *aulae* and basilicas can be traced back to the Domus Flavia and its arrangement around the peristyle, and the other reception spaces (Basilica, Aula Regia, Lararium and Cenatio Iovis). The Flavian palace was the nerve centre of the empire and the home of the emperor. Compared to the House of Augustus, the scale is larger but the new feature is the new types of rooms for reception. This Imperial development of reception spaces continues through the Palace of Diocletian in Split through the fifth century. As noted by Kim Bowes, the Late Antique *domus* and villa mimics this imperial development on a smaller scale. The Roman *domus* and its relation to the early Christian church (Table IV) has been studied since the 1960s.<sup>269</sup>

The features first seen in the Domus Flavia spread slowly to the patrician *domus* and villas. The expanding luxury of peristyles, fountains and *aulae* could plausibly also mean the growing public function of the Roman *domus* in late antique Rome.<sup>270</sup> The niches, apses and other *domus* architecture for receptions of the Domus Albinus V.I. (later Santi Quirico e Giulitta) surely got their inspiration from the neighboring imperial palace. Santi Quirico e Giulitta, according to Federico Guidobaldi, belongs to the same series of churches that had their origins in an *aula* of a *domus*.<sup>271</sup>

In Rome, the absence of the emperor during the third and fourth centuries encouraged the senatorial aristocracy to take a more leading role which was also represented by their building projects, as Federico Guidobaldi points out. The Domus Flavia was an obvious model.<sup>272</sup> The recognizable large *aulae* or basilicas were built on a smaller scale. The apse was not a new feature in Roman architecture but its heyday was in Late Antiquity. Kim Bowes calls it the "Shock of New" and whatever the motive in building the apse, it is

---

<sup>267</sup> Richardson 1992, 53.

<sup>268</sup> Brown 2014, 470.

<sup>269</sup> Bowes 2010, 21-23.

<sup>270</sup> Guidobaldi 1999, 56 and 62

<sup>271</sup> Guidobaldi 1995 in LTUR II. Guidobaldi 2007, 55-61.

<sup>272</sup> Guidobaldi 1986, 220-228; Guidobaldi 1993, 73; Guidobaldi 1999, 57-59.

most certain that it provides a focal point for an activity or a view. The apsed *aulae* were probably meant for dining or other social functions and the semicircular dining couch, *stibadium*, would support this theory.<sup>273</sup>

The qualities of a *domus* reception were important during the emperors' absence. Some indication of the Roman late antique *domus*' size is provided by the record of the senate's meeting at the home of the praetorian prefect and consul Anicius Acilius Faustus on 25th December 438 to mark the arrival of the new Theodosian Code.<sup>274</sup> There are records of public ceremonies in churches from the fifth century, but the location of civic activities still remained the Forum Romanum and Trajan's forum. This partially changed in the sixth century when Santa Maria Antiqua and Santi Cosma e Damiano were built near the Forum Romanum .

One of the problems when looking into the urban development of Rome during the third century is the Aurelian wall, as can be seen on Maps III and IV. As the Aurelian wall was built in the years 270-275, the question is, how much of the urban structure was actually left outside since the wall was built in haste? The incorporated funeral monuments and an amphitheatre, for example, yields an impression of an emergency at the end of the 3rd century. Quite obviously, the further development of Rome was from then on defined by the Aurelian Wall.

The Mithraeums shown on Maps II and III (16 locatable) are dispersed irregularly throughout the city. Mithraism was probably first brought to Rome by the soldiers serving in modern Syria. Since this Persian cult was first encountered by the Roman legions in the East and they probably brought it to the Empire as far as Britain, a close connection can be found just on the north side, the *Castra Misena*, or the naval barracks for the sailors that hang up the canopies over the spectator areas in the Colosseum. Thus, there is a connection of a sort with the San Clemente's *Mithraeum* and the immediate surroundings.

The other common factor with the 16 Mithraeums on Map II is the underground or semi underground location in a pre-existing building, meaning that they were not built as separate buildings. The Mithraeum's location in San Clemente is in many ways different compared to the others on Map III. Except for the Mithraeum near the Circus Maximus (13) all the other Mithraeums seem to be quite far away from any major public buildings. The urban relation between the Mithraeums and the density of *domus* is shown on Map II.

The Mithraeum at San Clemente corresponds well with the Mithraeum under San

<sup>273</sup> Bowes 2010, 54-60.

<sup>274</sup> Humphries 2007, 45, 51; Lançon 2001, 52.

Lorenzo in Damaso because of the location in connection with a *domus*. However, architecturally the best equivalent is the Mithraeum under Santa Prisca. The Mithraeum's cave is built in the middle of a *cryptoporticus*, as at San Clemente.<sup>275</sup> The building history of a *domus* with its lower levels filled in for the succeeding basilica on top, Santa Prisca is the most similar example to that of San Clemente.

The similarities between Mithraism and Christianity have been studied for the past hundred years. Many common points have been found, even though one was for small exclusive groups and the other for the masses. The sites also bear similarities, especially in Ostia, where a Christian place of worship replaced the Mithraic cult. Like third century Christianity, the Mithraic cult was very adaptable when building shrines.<sup>276</sup> In this sense, it would not be unusual if the early Church and its early patrons would immediately assimilate the domestic architecture into the new, more monumental Christian one in the post-Constantinian period.

Another type of early Christian patronage was an intellectual one. The intellectual activity in Rome remained rooted in the *domus*<sup>277</sup> and was centered in the houses of wealthy patrons. Intellectuals such as Jerome, Rufinus or Ambrosius who enjoyed the hospitality of wealthy patrons, would later make especially the female patrons famous for their piety (Chapter 3.2). Before the “proper” church organization, these kinds of devotion, concentration on relics etc. were also important.<sup>278</sup> This possibly also led to a conflict with the bishop and the later decrees of Pope Gelasius (492-496) would narrow the autonomy of this private worship, which in the Roman world would be a public matter. During the 4th century, the politically weak bishops did not approve of the religious competition indulged in by the newly converted Roman elite, such as Paulinus Nolanus.

The total size of the first alleged *domus* under San Clemente's apse is not known. According to the archaeological evidence, the northwest corner of the *domus* could be located (the third century Phase with the Severan water tanks), but everything else is unknown.<sup>279</sup> After Junyent, there have been no attempts to reconstruct the *domus* more closely, so I shall present my hypothesis in Phase IVb.

Unlike elsewhere in Rome, the Colosseum Valley after Nero was built on a *tabula rasa*, and it would be difficult to imagine the Romans building an urban development without regularity, symmetry or order at that time. Thus, it is plausible to assume that

<sup>275</sup> White 1990, II, 404-414.

<sup>276</sup> White I 1990, 47-59.

<sup>277</sup> Brown 2014, 301; Diefenbach 2007, 385-387.

<sup>278</sup> Boves 2008, 96-103, 218-220. Perrin in GC II, 667-679.

<sup>279</sup> Junyent 1932, 48, Fig. 8. The earlier mentioned cisterns (Drawing XII) were already proved by Guido-baldi to be of the Severan period and thus makes Junyent's reconstruction of the north side impossible.

the narrow alleys or streets on the north and south sides of the *horrea* continued to the *Armamentarium*. As presented on Drawing XII, being a new building and given the free space bordered by the *Armamentarium* and the fire alley, the outer measurements of the *domus* would probably be 100×110 RF, making the *Mithraeum* and the surrounding *cryptoporticus* its central feature. This leads to the nature of the upper floors, which have their rooms surrounding the *Corinthian atrium* over the *Mithraeum*. The only plausible solution to the atria is a *Corinthian atrium*, where the foundations of the pillars would be the walls separating the Mithraic shrine from the *cryptoporticus*.<sup>280</sup> The columns or pillars would support the gangways leading to the rooms on the upper floors. This arrangement would make the building relatively luxurious, given the rich decorations existing in the basement. With three floors, the approximate covered area in the *domus* would be ca. 2400 m<sup>2</sup>. This is, of course, an architectural analysis based on one half preserved floor and another partially preserved one. However, given the rich decorations, wide stairs and *cryptoporticus* this would seem to be the most plausible reconstruction.

The decorations on the level of the Mithraic Shrine (3.5 m, 58 m<sup>2</sup>) and the surrounding *cryptoporticus* (4.2 m) show that the subterranean quarters of the *domus* were not storage rooms, but normal living quarters. The chances of the later *Mithraeum* being a summer *triclinium* are good since the room can be entered through four different doors making the space seem to be a focal point of reception of the lowest level, and anyone, who has visited the site in August can agree with the temperature advantage. This has been a common feature even up to the present day in the southern Mediterranean, where in more well-to-do houses in the city, the living quarters change according to the season. The wide stairs leading to the *cryptoporticus* also provide an impression of a semi public space for entertaining guests during the summer months, if the *dominus* is in the city on business and not in the villa in the *suburbium*. There is no evidence and it would have been impossible that there was any kind of a water reservoir under the *Corinthian atrium*. Otherwise, the *cryptoporticus* would have been under water and unusable due to continuous leakage. There would have been no reason to preserve water anyway since Rome was supplied with water via aqueducts in this period.

The *horrea*, even though only partly excavated, is an easier reconstruction and for the past 100 years the length has been set at 220RF. The width is known to be 100RF. The length also corresponds with the outer measurements of the gate building and *prothyron* of the present 12th century San Clemente since it is logical to assume that, as during

---

<sup>280</sup> *Corinthian atrium* is actually a bit misleading since this is used in the Pompeian context and the late antique *domus* in Rome has very little to do with Pompeii. However, there is no use for inventing a new term for this in this context except to note that the *Corinthian atrium* is architecturally comparable to the typical Italian colonnaded *cortile*.

the building phases of the lower church, the successive load bearing structures overlap. The arrangements during Phase III blocked most of the doorways, changing the open nature of the floor into a more private and excluding one. This was customary since the Mithraic cult was extremely exclusive (first of all excluding women) and was based on secret mysteries, which is another reason why little is known of the cult. The *Mithraeums* in Rome were in general in private buildings (9 of 16 in Map III). During the same phase, the other Mithraic embellishments were also added along the possible *triclinium* etc. However, the changed function from a semipublic summer retreat to a shrine for a secretive cult does not mean that the *domus* changed from semipublic to private. On the contrary, the image of the *domus* would change in the public eye from a *domus* to a place where exclusive religious celebrations were held.

The other public feature comes from the surrounding urban topography. The vast Colosseum, the four *Ludi* and the adjoining service buildings had housed and employed thousands of people along with gladiators and exotic beasts. The inscription that records the *procurator Monetae et ludi magni*<sup>281</sup> mentioned in Chapter 1.3 would make this a place of control of both the Imperial Mint and the four *Ludi* under the same person of equestrian rank.<sup>282</sup> It is tempting to speculate that one of the few residential buildings in an area dedicated to public spectacles would be the *domus* of the procurator in charge of them. According to Coarelli, this *domus* is a public building and not a residential one. On the other hand, we know many *offices* from the literary sources but no antique “office building” has yet been excavated. In my opinion, this *domus* was probably also the office space of the *office* held by a Roman aristocrat, thus making it partly a public building. This could probably, as has already been proposed, be one of the reasons the Roman aristocracy maintained their residences in the city even though the emperor held the power had been out of the city since Trajan. While living in their own landed power bases outside the walls, they still had to perform their duties for their offices and the senate.

---

<sup>281</sup> CIL 6.1647. Even though broken, it is still readable.

<sup>282</sup> Coarelli 2007, 172-175. Coarelli states that Imperial Mint was located there and that the *domus* was of a public nature. Guidobaldi, however, disagrees.





Fig. 3.1.01. Casa del Fauno in Pompeii. There is still uncertainty on the function of the *aula* or *exedra* opening onto the peristyle.



Fig. 3.1.02. Domus Flavia's peristyle and the central feature (Drawing XXII). According to Guidobaldi, this could be the example that was mimicked in Rome in Late Antiquity.



Fig. 3.1.03. Hadrian's Villa in Tivoli, a scale model in the Villa Adriana museum. This villa would have been the prime example of the organization of the flowing open spaces that are also discussed in Chapter 3.2.



Fig. 3.1.04. Domus della Fortuna Annonaria in Ostia (see also Drawing XXIV). The polifora bears resemblance to the *narthex/polifora* in Roman churches. The open organization of space from the apsidal *aula* to the *peristyle* is typical of the late antique *domus*.



Fig. 3.1.05. Casa dei Fortuna Annonaria in Ostia (see also Drawing XXIV). The niches and the *nymphaeum*.



Fig. 3.1.06. The entrance to the Domus dei Protiro in Ostia. Casa dei Fortuna Annonaria is not the only *domus* with open spatial organization.



Fig. 3.1.07. Domus dell'Opus Sectile in Ostia (Porta Marina) and the *tablinum/aula/exedra* of the house in the Museo dell'Alto Medioevo in Rome. This *opus sectile* has also been used in the reconstructions in Chapter 4.



Fig. 3.1.08. The so-called Theodoric's Palace in Ravenna. The same architectural themes as found in early Christian churches are visible in the remaining façade.

### 3.2 Literary evidence for the late antique *domus*

Gerontius' *Life of Melania the Younger* gives us a glimpse of the splendor of late antique villa and *domus* living. The description of Melania's early life provides us a look at late antique Roman luxury:

*Unbridled love of pleasure, luxury, pomp and pride : such were the chief factors in the life of the Roman patrician. To lead an honest, humble life was held to be the mark of either meanness or stupidity. Hence the profusion of palaces and villas rivaling even imperial magnificence. Spacious vestibules adorned with a dazzling wealth of gilding, columns of precious marbles, pavements in mosaic of the most intricate design, gorgeous private basilicas, hippodromes, piazzas, fountains, baths, temples: such was the bewildering sight which met the eyes of the astonished stranger, to whom the great houses and villas of the patricians presented the appearance of miniature towns. The orator Symmachus, who, according to Olimpiodorus, had relatively but a modest income, possessed three magnificent palaces in Rome, as well as fifteen villas to which he could betake himself whenever he needed change. The furniture too, deliciarum suppellex, corresponded with the magnificence of these delightful palaces. Gold, silver, ivory, bronzes, marbles, and rare stones of every kind, statues, candelabra, vases, richly dressed pages, exquisite robes, carpets upon which historical figures were represented: all that the most refined, luxurious taste could conceive was gathered within those walls<sup>283</sup>*

The disapproval of luxury in *Vita Melaniae* is tangible. However, the description of the early Christian basilical interiors during Damasus' pontificate is basically the same: *At the same time, devotion to the martyrs, whose tombs extended for three miles round the walls of the Eternal City, reached its climax in the second half of the fourth century, particularly during the pontificate of Damasus, to whom the cults of the martyrs was specially dear. From those sacred tombs, enclosed within the walls of magnificent basilicas, and adorned with marble, encased in gold and silver, perfumed with incense and balsams, illumined by the mystic light of tapers and lamps, and overshadowed by the symbolic mosaics of the sanctuary, there breathed in all the fullness of its power the good odor of Christ, and there was revealed in all its grandeur the heroism which is the fruit of the Gospel.*<sup>284</sup> Even if we are discussing the similarities between the *domus* and the basilica, Melania would probably not have seen it in the same way even though the vivid descriptions bear resemblance to one another. The previously mentioned *Domus Flavia* and Hadrian's villa in Tivoli come to mind from Melania's descriptions.

---

<sup>283</sup> Gerontius, *Life of St. Melania*, 18

<sup>284</sup> Gerontius, *Life of St. Melania*, 34.

The motives for early Christian endowments are not the subject of this chapter but it is well to point out that the early Church Fathers encouraged this activity. As in the *Vita Melaniae*, a senior African bishop says: *...the most saintly and important bishops of Africa (I mean the blessed Augustine, his brother Alypius, and Aurelius of Carthage) advised them, saying, "The money that you now furnish to monasteries will be used up in a short time. If you wish to have a memorial forever in heaven and earth, give both a house and an income to each monastery."*<sup>285</sup> Peter Brown would probably call this as a classic case of investing in the "Treasure in Heaven".<sup>286</sup>

The private sphere of the *domus*, where the *paterfamilias* rule was traditionally unquestioned, was challenged by the bishops, as Kristina Sessa has pointed out. The domestic situations in *Gesta de Xysti purgatione* (pontificate of Sixtus III 498-514) paint a picture of meddling bishops trying to rescue beaten slaves and pious daughters from the rage of the *paterfamilias*. In this narrative, the private *domus* fades into a place of impious men who try to resist the bishop.<sup>287</sup> This is a change from the earlier *Passion of John and Paul*, the martyrs who died defending their property from the greedy Emperor Julian (the Apostate), and later they were buried in their own *domus*.<sup>288</sup>

Gaius Sollius Modestus Apollinaris Sidonius (ca. 430-489) simultaneously represents a fourth century aristocrat, writer and bishop. Even though he is best remembered as the narrator of the Roman downfall in Gaul, he also provides valuable evidence on his position as an aristocratic landowner. Sidonius gives us brief glimpses of the sumptuous living in Roman villas. These are valuable for the understanding of high-end living in a Roman house with all the vast numbers of jeweled tables, dining couches of Assyrian purple and silver plating.<sup>289</sup> In a poem to Tonantius Sidonius describes the banquet with *Bring the couch red with fine linen, bring the gleaming purple which the meliboean dye stains in the twice-boiling cauldron, to enrich the absorbent show in embroidery the hills of Ctesiphon and Niphates and beasts rushing over the roomy cloth, their rage wetted by a wound well counterfeited in scarlet, and, at the seeming thrust of a javelin, blood that is no blood issues; where the Parthian, wild-eyed and cunningly leaning over with face turned backwards, makes his horse go and his arrow return, flying from or putting to flight the pictured beasts. Let the round table show linen fairer than snow and be covered with laurel and ivy and vine-shoots fresh and verdant. Let cytisus, crocus, starwort, cassia, privet, and marigolds be brought in ample baskets and color the side-board and couches*

<sup>285</sup> Curran 2002, 315.

<sup>286</sup> Brown 2014, 72.

<sup>287</sup> Sessa 2007, 83-91, 97-99.

<sup>288</sup> Leyser 2007, 142.

<sup>289</sup> Sid. Apoll. *Carm.* 17.1-10. There are private baths also mentioned, for example, in Sid. Apoll. *Car.* 22, 23, *Epist.* 2.2, 4-10.

with *fragrant garlands*.<sup>290</sup> This would be the equivalent of Sir Lawrence Alma-Tadema's paintings in embroidery and flower arrangements.

One of the important attributes of social standing for Sidonius seems to be the private bath since he also composed a poem to his own.<sup>291</sup>

Sidonius' poem *Castle of Pontius Leontius*,<sup>292</sup> describes a Roman domestic building with flowing space closely resembling Paulinus' description of his church in Nola. Sidonius guides the reader through the porticoes, baths and dining rooms which are joined together, forming an architectural unity. The same flowing nature of space is also described in his own rural villa in Avitacum. In a letter to Domitius, Sidonius first describes his baths and then the villa itself. Again he moves the reader from the baths to the dining room through porticoes uninterrupted by partitions.<sup>293</sup> The path continues through a *cryptoporticus* to a winter dining room and from there to the smaller dining rooms equipped with an expensive *stibadium*.<sup>294</sup> One can easily sense the owner's pride throughout the lengthy description. The complicated seating orders on the *stibadium* are described in a letter to Montius.<sup>295</sup>

Sidonius' remarks on Roman *domus* are few. The letters to Heronius concerning the wedding of Ricimer<sup>296</sup> (468) contain a brief description of Paulus' house (prefectorian rank).

Sidonius writes about the *patrimonium* in his letter to Avitus in 471.<sup>297</sup> Sidonius thanks Avitus for a gift of land in Cuticiacum (France) for the church. The curious point is that under the threat of the Goths in Gaul, frequently mentioned in Sidonius' letters, Avitus should still use his legal right to patronage over this particular *patrimonium*. In my opinion, this is interesting when considering the lately discussed problems of patronage and endowments. The threat of the Goths probably made the gift of land a pointless one. However, this could mean also that endowments were overseen by the donors.

<sup>290</sup> Sid. Apoll. *Carm.* 9.13,5: *Rutilum toreuma bysso/rutilusque ferte blattas, recoquente quas aeno/Meliboea fucat unda, opulentet ut meraco/bibulum colore vellus. peregrina det supellex Ctesiphontis ac Niphatis/iuga texta beluasque/rapidas vacante panno, acuit quibus furorem/bene ficta plaga cocco/ iaculoque ceu forante/cruor incruentus exit; ubi torvus et per artem/resupina flexus ora/it equo reditque telo/simulacra bestiarum/fugiens fugansque Parthus. Nive pulchiora lina gerat orbis atque lauris/hederisque pampinisque/viridantibus tegatur. Cytisos, crocos, amellos, casias, ligustra, calthas calathi ferant capaces, redolentibusque sertis/abacum torosque pingant.*

<sup>291</sup> Sid. Apoll. *Carm.* 18 and 19.

<sup>292</sup> Sid. Apoll. *Carm.* 22.

<sup>293</sup> Sid. Apoll. *Epist.* 2.2,9-10: *a parte vestibuli longitudo tecta intrinsecus patet mediis non interpellata parietibus.*

<sup>294</sup> Sid. Apoll. *Epist.* 2.2,11.

<sup>295</sup> Sid. Apoll. *Epist.* 1.9,10.

<sup>296</sup> Sid. Apoll. *Epist.* 1.5 and 9.

<sup>297</sup> Sid. Apoll. *Epist.* 3.1, 2-5.

*Saturnalia* by Ambrosius Theodosius Macrobius (395–423) presents a lengthy academic discussion in the manner of Cicero. On the eve of the Saturnalia festivities, a small group of late antique Roman aristocrats discuss various subjects, mostly Vergil and Homer. The men are Caecina Decius Albinus Iunior, Vettius Agorius Praetextatus, Virius Nicomachus Flavianus, Quintus Aurelius Symmachus, Publilius Ceionius Caecina Albinus, Rufius Albinus, Eustathius, Avienus, Eusebius, Servius, Evangelus, Dysarius and Horus. Saturnalia's discussions take place over several days in the domus of Praetextatus' (Reg. V; Nr. 27; Map III N-10), Symmachus's (Reg. II, Nr. 8, Map III J-14) and Flavianus' domus shown in Table III and Map III. When Decius is asked about a previous banquet in Praetextatus' domus, Macrobius hints at an aristocratic scholarly social life, wandering from domus to domus according to banquet invitations and counter invitations.<sup>298</sup>

*Saturnalia* does not reveal much about the nature of the domus, except in Book III, where a late Republican pontiff's dinner is discussed: *On the ninth day before Kalends of September, on which day Lentulus was inaugurated as flamen of Mars, the house was decked out, the dining rooms laid with ivory couches; the pontiffs reclined in two dining rooms...in a third dining room there were the Vestal Virgins...*<sup>299</sup>

The location of Decius' domus is also known (Reg. XIII; Nr. 54; Map III G-15). Symmachus' domus on the Caelian Hill was one of the largest in late antique Rome. Several inscribed finds have identified it with certainty.<sup>300</sup> In a letter of Symmachus to his father, another domus is mentioned where there are repairs being done.: *Fine marble has been laid on the stairs. The upper rooms have been covered with a veneer of such delicacy that, despite the joints, it gives the illusion of being made of one solid piece. You paid no more for the columns than if they had come to you as a gift.*<sup>301</sup>

*Saturnalia* is also a valuable testimony to late antique aristocratic communication. Book VII's introduction gives a lengthy description of banqueting as an academic *soiree*.<sup>302</sup>

Even though the literary evidence for the Roman domus diminishes, it still shows the craving for such *salon-culture* in late antiquity. The change from the Republican era

---

<sup>298</sup> Macrobius *Sat.* 1.1.7-2.9.

<sup>299</sup> Macrobius *Sat.* 3.13.10-13.12: *Ante diem nonum Kalendas Septembres, quo die Lentulus flamen Martialis inauguratus est, domus ornata fuit, triclinia lectis eburneis strata fuerunt, duobus tricliniis pontifices cubuerunt...in tertio triclinio...virgines Vestales.*

<sup>300</sup> Carignani 2000, 149-51; Carignani 1993, 468-92, 496-502. The house on the Caelian mentioned in *Saturnalia* would have been ca. 6500-8500 m<sup>2</sup>. The architecture consisted of the rich *opus sectile*, niches and apses as discussed in this chapter.

<sup>301</sup> Symmachus *Ep.* 1.12: *Scalis subpectus est honor marmoris; superiora conclavia crustis tegentur ea operis levitate, ut conpago solidum mentiatur. Columnas nihilo amplius mercatus es, quam si tibi muneri contigisset.*

<sup>302</sup> Macrobius *Sat.* 7.1.1-23.



*domus* is that there are many more luxuries, such as marble and tapestries and these features put the late antique *domus* and the early Christian basilica on the same level. There is no longer Cato's disapproval of luxury.<sup>303</sup> In my opinion, it would be strange not to have the same decorative pomp in the privately funded churches of Rome as in their benefactor's *domus*.

---

<sup>303</sup> Gell. *NA*. 2.24.1-15.

### 3.3 The 4th century *domus* and *titulus* in Rome

This chapter continues the previous chapter from a more legal, real estate and financial point of view, relating to my hypothetical Phase IVb.

The Constantinian building program concentrated mainly outside the Aurelian Wall. The *deambulatorio*-basilicas like Saint Peter's and the Lateran were built along the main arteries. The Lateran was built just barely inside the walls and over the barracks of the Equites Singulares.

The first churches inside the walls were built over pre-existing properties donated by the ruling classes, one comes to ask how large was Constantine's real estate portfolio in Rome, including the imperial *patrimonium*? It would be bad politics from a fresh emperor to start confiscating prime real estate from families that had owned it for centuries.

As mentioned above, the pre-Constantinian places of worship were most plausibly situated in the houses of the wealthier members of the Christian community. These houses were modestly adapted to accommodate Christian rituals.<sup>304</sup> The Constantinian period's places of worship probably did the same most, but in more luxuriously. The urban renewal of the Severan period with the expanding and more lavish urban *domus*, the new features of *aulae*, like in Santi Quattro Coronati were in some cases modified for Christian rituals. The number of *aulae* modified into a church combinations in Rome would support this point as presented in Table IV.<sup>305</sup> The mesmerizing fact of little or no archaeological evidence could be explained by the absence of "Christian architecture" proper before Constantine. The attributes of a Christian place of worship were probably more "mobile" than "immobile". After the *aula ecclesiae*, religion was probably largely a family matter in a *domus*. If the houses of the billionaire Koch brothers would suffer a thousand years of Goths, earthquakes and Robert de Guiscard, the archaeological finds would probably be limited to single objects such as the 4th century bronze lamp of the Valerii in the form of a ship steered by Saints Peter and Paul. The literary evidence might be a vague remark on a disagreement over authority with Pope Francis II.

The Synod of 499 lists the 25 *tituli*.<sup>306</sup> The assumption that these *tituli* were not under the

---

<sup>304</sup> Bowes 2008, 49. More on the subject of house churches: Beta Brennk, *Die Christianisierung der spätrömischen Welt. Stadt, Land, Haus, Kirche und Kloster in frühchristlichen Zeit*, Reichert 2003, Wiesbaden. In detail, for example, and concerning the *domus* itself: Kristina Sessa, *Christianity and the Cubiculum: Spritual Politics and Domestic Space in Late Antique Rome* in the *Journal of Early Christian Studies* 15:2 2007. Relating to Kristina Sessa and about the multiple purposes of the Roman *domus* in general, Tuori 2015.

<sup>305</sup> Bowes 2008, 71-82.

<sup>306</sup> This has been later proven to be false or misleading. See, for example, Piétri 1978.

direct control of a Bishop was first made by Kirsch.<sup>307</sup> Of these *tituli*, 13 are clearly related to a patron ( Damasi, Vestinae, Clementis, Gaii, Aemilianae (ss. Quattuor Coronatorum), Anastasiae, Caeciliae, Sabinae, Pammachi, Apostolorum, Sancti Matthaei and Sancti Laurentii).<sup>308</sup> However, the dating of the *tituli* has gone through a long examination following the research of Charles Piétri and the number 25 has been reduced to a working number not to be taken literally.<sup>309</sup> The proprietorship of the *tituli* will be discussed below.

The discussion about the nature of the Roman *tituli* and their origin in the pre-Nicene world has been undercut by a “systematic historiographic wrecking ball”, as Kim Bowes has neatly put it.<sup>310</sup> What would seem to be apparent is that the history of the *tituli* is not pre-Constantine.<sup>311</sup> In short, the first church building in Rome would be a Constantinian project and after a short lapse, continuing inside the walls as a project run by the Roman aristocrats before finally becoming an Episcopal project in the fifth century.<sup>312</sup>

Julia Hillner has discussed the Roman judicial terminology behind the term *titulus* and reached a contradictory view to that of Charles Pietri (that the *tituli* were independent) that the *tituli* would have not been completely independent from the Episcopal power. Recognizing *Liber Pontificalis* as a biased account of church building, Hillner does not suggest that the *tituli* were not lay foundations but she proposes a separate institution of foundation and outside provision of an endowment for the *tituli's* upkeep.<sup>313</sup> Several accounts in the literary evidence (*Liber Pontificalis*: Vestina, Demetrias and Valila or the records on the Laurentian Schism and the *Gestae* of *Praxedis*, *Pudentianae* etc.) might point towards more centralized church building. These accounts for about five different cases and they do not correspond with the archaeology.

In the ten years following Charles Pietri's and Victor Saxer's<sup>314</sup> studies on *tituli* of Rome, there has been a lot of discussion on the subject. The prime scholar on San Clemente (Federico Guidobaldi) has also made his point of the nature and distribution of the *tituli* mainly in the areas rich with late antique *domus* <sup>315</sup>.

---

<sup>307</sup> Kirsch 1918, 6-12. Later on also Pietri 1978; Saxer 2001.

<sup>308</sup> Diefenbach 2007, 338-358; Hillner 2007, 190-225.

<sup>309</sup> Piétri 1978.

<sup>310</sup> White 1990, I, 18.

<sup>311</sup> Ward-Perkins 2002. In his “From Classical Antiquity to the Middle Ages – Urban Public Building in Northern and Central Italy AD 300-850” he considers the patrons and builders of the new basilicas in the beginning of the fifth century, and the shift of patronage from classical temples to Christian basilicas. The book also includes a comprehensive list of Roman basilicas and their patrons.

<sup>312</sup> Bowes 2008, 71-74.

<sup>313</sup> Hillner 2007, 257-258, points out that the motives behind *titulus* are far from clear.

<sup>314</sup> His last entry on the subject, Saxer 2001b, 217-221.

<sup>315</sup> Guidobaldi 1999, 65-68; Guidobaldi 2000, 123-131; Guidobaldi and Guiglia Guidobaldi 2002, 1033-1073.

However, this dissertation is not a re-examination of the acquisition process, endowment tradition and judicial terminology of the *tituli* in late antiquity. Even though there has been much debate on the exact meaning of the word and whether the *tituli* were under the Bishop of Rome's direct control or under direct patronage of the provider of the estate and endowment, it is important to remember, in my opinion, that even if the estate was provided by a layman along with the funds for upkeep, the funds most certainly would not have been enough to finance a complete rebuilding or remodeling of the fifth century churches. One possibility is that the patronage moved from private to public when the rebuilding and its financing took place. This would be hard to prove since it would require late antique documents of transaction or the like, but in my opinion, it would be the simple answer.

Richard Krautheimer's estimate of total capacity of the 4th and 5th century churches' is 20,000 and thus he puts weight on the informal places of worship such as "community centers" and privately owned *domus ecclesiae*.<sup>316</sup> The *Liber Pontificalis* or *Notitia Ecclesiarum Urbis Romae* does not correlate with the archaeological evidence from Rome very well. They do not directly answer the questions who built what, where and when. This also applies to San Clemente. As Peter Brown points out in his colossal study *Through the Eye of a Needle*, the *Liber Pontificalis* was also a representation of the Roman church's acquired wealth. I suggest it would be thus logical to assume that the churches not mentioned in the *Liber Pontificalis* were financed by autonomous individuals or autonomic entities (*collegia*).

Roman public building slowed down after several legislative measures directed by the *praefectus* and senate. The traditional way of self-promotion by public building was banned and the resources were to be directed to the existing structures and their upkeep.<sup>317</sup> However, the legislation did not include the bishop or private individuals. This legislative measure along with the fact that classical Roman law had no concept of an "abstract legal personality" before Constantine would favor private ownership of the *tituli* before the more abstract Episcopal ownership.<sup>318</sup>

Paulinus Nolanus is a good example of aristocratic freedom. When Paulinus was ordained a priest in Barcelona, he immediately left for Nola where he had family property. He did not stay in Barcelona and work his way up the ladder, as was expected. The Bishop of

---

<sup>316</sup> Krautheimer 1983, 102; Cooper 2007, 172-173.

<sup>317</sup> Ward-Perkins 2002, 40.

<sup>318</sup> Hillner 2007, 237. For a longer discussion on the subject, see Philipsborn 1854, 41-70; Kaser 1975 [1971], 302-310.

Rome (Siricius) did not approve of this, but could do nothing to prevent Paulinus moving to Nola and laying up his personal “Treasure in Heaven”.<sup>319</sup>

Later from the bishop’s point of view (Innocentius), this approved way of laying up this “Treasure in Heaven” was that of the *illustris femina* Vestina. Innocentius built and financed San Vitale by selling her “ornaments and pearls” at an “expert estimate price”. The revenue for the *titulus* came from urban real estate (a bakery, a bath, a toll gate, and some estates in Etruria and Campania).<sup>320</sup> In the 5th century, the relations between the clergy established in *tituli* and the bishop were fragile, the literary evidence shows even fatal clashes between the rival factions.<sup>321</sup> Because of the endowments and patronage, the clergy could enjoy near independence from the bishop.<sup>322</sup> In my opinion, the question “who built and financed” could possibly explain the lack of literary evidence corresponding to the archaeological evidence.

The other female benefactor of the church mentioned in the *Liber Pontificalis* is the previously mentioned Demetrias who built Santo Stefano in Via Latina inside her villa.<sup>323</sup> An inscription found at the site demonstrates that Demetrias, like Vestina, was a favored benefactor of the church: *When the Amnian virgin Demetrias leaving this world brought to a close her last day she gave to you, Pope Leo, this last of her vows, that this scared house arise. The trust of her command is fulfilled, yet it is more glorious to carry out a vow inwardly than outwardly. Stephen, who first in the world was carried away by savage death, and reigns in the height of heaven, had crowned the work. By order of the bishop, the presbyter Tigrinus serves in this hall, sleepless in mind, work, and faith.*<sup>324</sup> The motive for the building project and endowments might have been the intended relation between St. Stephen and Demetrias’ to bolster her own dynastic strength, as Anne Kurdock has pointed out.<sup>325</sup>

However, there is a lack of privately funded church building mentioned in the *Liber Pontificalis*, except that of the illustrious women such as Demetrias and Vestina who were building “under the vows to the Pope” and “by order of the bishop”.<sup>326</sup> Unlike Paulinus, who went where he wanted, built what he wanted and financed it himself and was probably thus eventually dropped out of the *Liber Pontificalis*.

---

<sup>319</sup> Brown 2014, 225.

<sup>320</sup> LP, *Innocentius*; Brown 2014, 246.

<sup>321</sup> Brown 2014, 466.

<sup>322</sup> Brown 2014, 489.

<sup>323</sup> LP 47.1.

<sup>324</sup> ILCV, 1765.

<sup>325</sup> Kurdock 2007, 223.

<sup>326</sup> Bowes 2008, 94-96.

The senator Flavius Magnus Aurelius Cassiodorus Senator (ca. 485-585) mentions ecclesiastic property in a letter concerning a dispute between the Roman Church and the Samaritans. The subject was a house in Rome that the Samaritans had used as a synagogue. However, as Cassiodorus points out using Theodoric's voice, the building was in the "style" of a private *domus* and not that of a synagogue. This is interesting in many ways since Pope Simplicius originally acquired the *domus* with "all proper formalities" from Eufrasius the Acolyte.<sup>327</sup> Simplicius had also acquired earlier a *domus* which became Santa Bibiana. Cassiodorus' letters also give other hints for acquiring real estate in Rome. In Book VII containing formulas for letters, there is a standardized formula for granting public property on condition of improvement (which is also quite normal nowadays). The following letter, on the other hand, is a standardized formula for remission of taxes on a house. The letter first points out the normal possible choice of surrendering the house if the taxes are too heavy to bear. However, as the formula continues, an imperial waiver of taxes is declared.<sup>328</sup> These ready-made formulas for granting public property for free and on the other hand, removal of property from the tax-rolls first of all indicate the devaluation of real estate. This then relates to Simplicius and the ecclesiastical acquisition of real estate in general. If a synagogue would be installed in a *domus*, why not churches since it required the least the financial outlay?

The opposite view was offered by Aurelius Ambrosius a century earlier (ca. 340-397). Ambrose, in a letter to his sister, bitterly complains about the Arian controversy becoming prominent in Milan. The Emperor was to seize one of his basilicas and this produced a standoff between Ambrose's supporters and the court. Ambrose notes that troops had marked the entrance to the basilica using tapestries or banners signifying imperial custody of the place.<sup>329</sup> First of all, this would be a seizure of property, but whose property? As discussed above, this is the time, when an abstraction in civil law, such as the church, receives the status of a judicial person. The gap between Ambrose and Cassiodorus is close to a century. This probably just illustrates the judicial development of laws concerning private property and the owner as a legal person. This was a process that would take up to the medieval period.

An important phase of building activity in Rome was the pontificate of Damasus (366-384). His building activity was greater than his predecessors. The new churches included for certain Sant'Anastasia al Palatino, San Lorenzo in Damaso and Titulus Fasciolae. San Paolo fuori le mura was also started during his pontificate. Even though San Clemente

---

<sup>327</sup> Cassiod. *Ep.* 3.45.

<sup>328</sup> Cassiod. *Ep.* 7.44-45.

<sup>329</sup> Ambrosius *Ep.* 20, starting from 20.19. This continues in Letter 21. Ambrose provides us another interesting point, that the ministers of the church were not able to inherit private property (*Ep.* 18.14).

was outside the scope of projects begun by the pope, San Lorenzo in Damaso has a link to San Clemente in its founding. In addition to the endowments provided by Damasus, there is a possibility that the basilica was built on the site of his own family home.<sup>330</sup>

The flight of patrician refugees to Africa, such as Melania the Younger, who helped to finance church building, there were also people like Damasus. The bishop Alexander built a church near the bay of Tipasa (some 500 km west of Hippo), in which he raised an inscription: *Here, where the walls are rendered praiseworthy by a light-filled roof, where the vaults shimmer and you see the holy altar: this is not the work of any magnates. No: the glory of such a deed rebounds through all ages to Alexander, Ruler (of the flock).*<sup>331</sup> The inscription clearly states that the church was not financed and built by Roman patricians or the local plebs.

These examples of early Christian church building above support the proposed chronology of San Clemente. Reconstructing the appearance and function of Phase IVb of San Clemente is the hardest since there is so little left. There seems to be no symmetry. One of the reasons might be that it was never finished. The remaining few decorations point in the direction of a domestic building.<sup>332</sup> However, whether one of the proposed *domus* would have been the house of the third pope, the answer is no. The earliest inscription in Rome relating to Clement still remains that on the slave's collar from the Constantinian era.<sup>333</sup> The latest research on Church history still sometimes kindles the hopes that this could be established, but in the context of this chapter, it does not seem to be plausible. However, the discussion on Pope Clement's house still continues among Church historians.<sup>334</sup>

If the decision concerning the evidence for San Clemente's Phases IV-IVb is made in favor of a 3rd century domestic building, the surroundings would support the theory since the north side would also be residential at this time. Even though the part of Phases IV and IVb close to the *domus* is hard to reconstruct though the later phases of the site provide some clues to the appearance. During the later phases, when the *horrea* is turned into another *domus*, the load bearing structures overlap the pre-existing ones. In a similar way, when Phase IV is in turn converted into the Lower Church (Phase V) at the end of the fourth century, the later conversion could reflect the appearance of Phase IVb. Since the "Lower Church" had a *quadriporticus* (not excavated, but the *narthex* points this direction), it is possible to imagine a *domus* with an extensive peristyle. The inside of the

<sup>330</sup> Curran 2002, 142-147.

<sup>331</sup> Brown 2014, 336.

<sup>332</sup> Guidobaldi 1992, 1, 114.

<sup>333</sup> CIL 15.7192: *Tene me quia fug(i) et reboca me Victori acolito a(d) dominicu(m) Clementis.*

<sup>334</sup> Jeffers 2007, 63-89. This is one of the latest efforts to prove the site was Clement's house.

*domus* would probably consist of more public rooms for reception or dining purposes. It is important to remember that during this time Rome was very densely built, so building higher would serve a purpose. This would mean a preference for the high status value of a peristyle instead of normal living quarters on the first floor.

As Olof Brandt argues, the theory of Johan Peter Kirsch of the Christian activity before the early *tituli* has never been archaeologically proven. Despite this fact, the theory still tempts some scholars to search for evidence for the private *domus* preceding the churches.<sup>335</sup> However, in my opinion, the evidence might more probably be *mobile*, not *immobile*. As was the case in the *Domus Valerii*. A cult operating in its early stages does not leave much architectural evidence because it has not been formalized yet.

The sheer number of churches built in a span of 50 years (last quarter of the 4th century until the end of the first quarter of the 5th century) is proof of a very active building program after the stagnation following Constantine's death. Not all of them were basilicas, but there were also *aulae* in a *domus*.

The building activity represented in Table IV is highest in Regio V (nine churches) and the second highest in Regio VI (five churches). This correlates with Table III and the *domus*. Twelve of the churches are extramural and the majority of them are Constantinian projects. This cannot be taken as statistical proof because the sample is too small, but in my opinion, with the scarcity of other evidence it points to the *domus* playing a part in this development.

Ten of the churches in Table IV have a *quadriporticus* (Sant'Agata dei Goti, Sant'Agnese fuori le mura A, Sant'Anastasia al Palatino, Sant'Andrea in Catabarbara, Santi Apostoli A, Santa Balbina, Santa Bibiana, Santi Bonifacio e Alessio, San Caio in Via Porta Pia and Santa Cecilia in Trastevere). San Lorenzo in Lucina is still a somewhat unclear case, but the latest study by Olof Brandt would indicate that it did not have a *quadriporticus*.<sup>336</sup> The *quadriporticus* has been traditionally considered a hallmark of a proper early Christian basilica, but the actual numbers of them in Table IV remain modest (10 out of 54). Another point of interest is that only a single early Christian *quadriporticus* has survived to modern times (Sant'Agata dei Goti with its later modifications). The rest is archaeological evidence. The churches that had a *quadriporticus* and were built in or on top of a *domus* are San Clemente, Santa Maria Maggiore, Santi Nereo e Achilleo and Santi Quattro Coronati. Santi Quattro Coronati's first building phase is especially interesting since the church was first built in an existing aula of a *domus* and thus incorporated its peristyle.

---

<sup>335</sup> Brandt 2012, 150.

<sup>336</sup> Brandt 2012, 149-150.



Out of the 54 churches in Table IV, 26 are built over or in a *domus*:

Sant'Andrea in Catabarbara  
Santi Apostoli A  
Santa Balbina  
Santa Bibiana  
Santi Bonifacio e Alessio  
San Caio in Via Porta Pia  
San Ciriaco  
San Clemente  
San Crisogono  
Santa Croce in Gerusalemme  
Sant'Ermete  
Sant'Eusebio  
San Giovanni a Porta Latina  
San Marcello al Corso  
San Marco  
Santa Maria Antiqua  
Santa Maria Maggiore  
San Pietro in Vincoli B  
Santa Prisca  
Santa Pudenziana  
Santi Quattro Coronati  
Santi Quirico e Giulitta  
San Saba  
Santa Sabina  
San Sebastiano fuori le mura  
Santa Susanna

This is nearly 50 % of the total. Since the *domus* is on private property, the late antique building of churches seems to have been highly dependent on private property. Five of the churches were built on top of an insula (Sant'Anastasia al Palatino, Santa Cecilia in Trastevere, Santi Giovanni e Paolo, San Lorenzo in Lucina and Santa Maria in Via

Lata). Building over military barracks (Santo Stefano Rotondo and the Lateran basilica) is an exception and thus, in a reverse way of thinking, San Clemente's Phase IVb being anything other than a *domus* would be statistically highly exceptional, even though 50 % does not prove the case, but it increases the possibility. Moreover, it most certainly does not statistically rule out the chance of San Clemente's Phase IV or IVb being a *domus*.

Of the 26 churches replacing a *domus*, seven were directly built into an existing reception hall or an *aula* (Santa Balbina, Santa Croce in Gerusalemme, San Marco, Santi Quattro Coronati, Santi Quirico e Giulitta, San Saba and Santo Stefano in Via Latina).

The rough sorting of the immediate neighborhood (Pu./Pri. = public versus private) of the churches has been done on Map IV and Table IV. In the ratio "Public/Private" the surrounding area of a church (radius 200m) has been measured and given a value from one to five. Value 1 represents a highly public area, 2 is more public than private, 3 is more private than public and 4 is highly private (meaning residential). Value 5 indicates an extramural location.

In Group 1 (highly public) are the four obvious churches of Santa Anastasia al Palatino, Santa Maria Antiqua, Santi Martina e Luca and Santi Quirico e Giulitta that surround the Forum Romanum. However, the vast majority are in Groups 3 and 4 (18 and 18). This also corresponds to the number of churches built in or on top of a *domus* and the distribution of them in Table III. After the Constantinian phase of church building, the early Christian basilicas in Rome were mostly built in residential areas not in a public context.

The orientation of the early Roman churches differs from the rest of Europe. The common orientation (the apse east, façade west) of the churches does not seem to be the custom in Rome. Olof Brandt has considered the plausible reasons for the differing orientation. The most plausible interpretation would be that the church itself gave the direction of prayer rather than the compass. The direction was emphasized by representing the sky on the ceiling or in the apse since early Christians prayed looking towards the sky. However, he also notes that any of the theories would be difficult to prove.<sup>337</sup> In Rome, the exceptional building of the churches on top or within existing structures would, in my opinion, explain the orientation. In Table IV, the orientation of the majority of the churches was already dictated by the earlier structures.

---

<sup>337</sup> Brandt 2014, 33.

### 3.4 Conclusion

The traditionally mentioned Pompeian or Herculanean *domus* are slightly misleading in the context of Roman late antique *domus*. However, Casa Tramezzo di Legno (Drawing XXIII) in Herculaneum already shows the Roman tendency in real estate development. The original atrium-house was extended with one or two smaller properties in order to build the peristyle. According to the Roman archaeological evidence, the peristyle was one of the main features in Roman aristocratic buildings along with the apsidal aula etc. Later on, when atriums cease to be built, the peristyles becomes the important transitional space.

Since there are only a few fully excavated *domus* in Rome, the closest comparable examples can be found in Ostia. Domus della Fortuna Annonaria has already been used as an example of the close connection of *polifora* both in Roman basilicas and *domus*. The plan is quite obvious, there is the peristyle and there is the *aula* and the connecting *polifora*. Without the *cubiculae*, this could be seen as a church plan (even though it never functioned as such). Domus della Fortuna Annonaria (Drawing XXIV) is not the only such example of the flowing organization of space in Ostia, but it is the best one. To some this point might seem trivial, but if we think of later church building in relation to domestic building, this is unique since design-wise it is close to the same.

The best known *domus* turned into a church is, of course, Palazzo Sessoriana. This would be the largest private property turned into a church. The previously mentioned Domus Flavia or Hadrian's villa belong to the same genre of palatial architecture. A more modest version of such architecture would be the Villa Romana in Casale (Sicily, Drawing XXV). This kind of architecture would have been familiar to Paulinus and Sidonius, the aristocratic clerics from Roman Gaul. The basilical complex in Cimitile (Drawing XXVI), produced here as a reconstruction from Paulinus' time, shows the architectural relation between the villa, the *domus* and the basilica with its free-flowing space through porticoes between the Basilica Nova and Basilica Vetus.

Examples closer to San Clemente are SS. Quattro Coronati (Drawing XXVII) and Santa Prisca (Drawing XVIII). The latter has been excavated during the campaigns of 1940, 1958 and 1965.<sup>338</sup> The first one was excavated recently by Lia Barelli.<sup>339</sup>

SS. Quattro Coronati makes an interesting comparison with San Clemente. The site was first occupied by 1st and 2nd century *insulae* later joined onto a larger property

<sup>338</sup> Carandini 1982.

<sup>339</sup> Barelli 2008, 2009 and 2016.

and re- and overbuilt as a luxurious *domus*. This first Christian gathering space was an apsidal hall later to be replaced with a basilica very similar to Santa Prassede by Leo IV (9th century). As in S. Balbina, S. Croce in Gerusalemme, SS. Quirico e Giulietta, S. Marco and S. Saba, the Christian space is in an *aula*. What makes SS. Quattro Coronati more interesting is the recently excavated peristyle and confirmation of Krautheimer's and Guidobaldi's theories of yet another church first built in a *domus*. And to add, to another peristyle, which was rebuilt as a *quadriporticus* later. How these spaces actually joined together cannot yet be ascertained, but according to the comparative material in this dissertation, a certain element of *polifora* or other open kinds of transitional spaces could be expected.

Santa Prisca, (Drawing XXVIII) on the other, hand shows an example of a church built in another luxurious *domus* with a verified peristyle/*quadriporticus* and a cryptoportico that was turned into a *Mithraeum* in the Severan period, just like in San Clemente. The earlier *aula* was rebuilt as a basilica in the 12th century, but it seems that it also had two aisles and a nave.

From my point of view, there seems to be a connection with the public and private spaces of a Roman *domus* and the Roman early Christian basilicas. As I have listed the material in Tables III-IV and Maps III-IV, it shows a clear connection between the *domus* and the church, where the church comes to replace the former. If we compare Drawings VI and IX to later churches, the openness of San Clemente and its peers (San Vitale) disappear in later ecclesiastical architecture and becomes more closed. As an open layout, San Clemente is architecturally closer to the late antique *domus* with free flowing space between the *aulae* and peristyles. The other interesting factor concerning the *quadriporticus* is that the colonnaded porticoes preceding the basilica virtually disappear in the Medieval period - except in Rome, where the Carolingian projects of Santa Prassede or Santi Quattro Coronati faithfully deploy (quite certainly consciously) the model of the early Christian basilica and continues in San Clemente itself with its 12th century rebuilding. This reformation or renaissance<sup>340</sup> or *renovatio* started by Gregorius VII was a power grabbing coup that also deployed art and architecture in its service. However, the medieval architecture in Rome is totally different from the rest of Europe. It seems that the Romans were happy to continue from where they left off in the fifth century. Architecturally, the cloister replaces the *quadriporticus*, but then its function is different from a monumentalized entrance. It is quite clear that the civic and ecclesiastical basilica belong to the same typology, only with differing functions, but how much did

<sup>340</sup> Renaissance is a term made more widely known by Erwin Panofsky in his *Renaissance and Renascences*.

the late antique *domus* with peristyles and apsed *aulae* influence this transition in the development of the Christian basilica?

People like Paulinus Nolanus were most certainly not anomalies, but Paulinus (and Sidonius) is known to us through his popular letters, despite the disapproval of the Roman bishops. The exceptional basilica complex in Cimitile also tells a parallel story of a conscious or unconscious building project inspired by the contemporary late antique villa architecture. Perhaps aristocrats in Rome did not possess the literary skills of Paulinus to make known their works for posterity?<sup>341</sup>

The similarities between the late antique *domus* and churches are vast apart from the fact that the churches were often built within or on top of them. The use of *polifora*, *opus sectile*, the literary evidence for similar decorations (wall hangings, silver candles, incense burners etc.) and the peristyle/*quadriporticus* provide extra evidence. To return to the abandoned 19th century German theory of the *domus* as the origin of the Christian place of worship: it might still hold some currency, but not in the way originally intended.

---

<sup>341</sup> Yasin 2010, 181-188. Yasin offers another view to the discussed flowing space by discussing the relation of open spaces leading to one another freely and being guided by saints relics as a focal point of the spaces.

## 4 Reconstructions and conclusions

In this chapter, I present the reconstructions and their documentation in relation to the comparative material presented in the previous chapters in accordance with *The London Charter* mentioned in the Introduction. These are reconstructions and thus present the hypothesis in a more detailed fashion than a written one could produce. I would strongly emphasize that the following is merely supportive documentation and the illustrations present the primary hypothesis.

The importance of this chapter, in my opinion, is that the previous reconstructions are already quite old and with mistakes. The possible interlude of a hypothetical Phase IVb is based on Chapters 2 and 3 and has never been presented but has been suggested here to make Phase V more plausible.

### 4.1 The archaeological remains of the 5th century basilica and its earlier reconstructions

As described above, the new basilica (Drawing VI-VIII) was founded on the already existing first century tufa walls and the third century Walls MA (southern wall), MB (northern wall) and XY (western wall).<sup>342</sup> The new apse was cut through Wall XY. Originally, the western wall had been the eastern wall of the *domus* but after its demolition, the eastern first floor rooms (the street level) had been taken in use for the new basilica. The western wall of the third century structure was demolished, thus extending the new basilica over the vaulted fire alley. On the north side of the apse, the original second floor rooms of the *domus* were incorporated into the new basilica by creating an entrance to the north aisle in the western wall. Therefore, the level of the apse floor was +25.50 (the nave ca. +24.65) as in the *domus*' first floor (second level). There are no remains of a similar arrangement on the south side, and I shall deal with this in this chapter. The door in the western wall in the west end of the southern aisle to the stairway for the Mithraeum gives us the opportunity to speculate about the use of the Mithraeum as the crypt of the new basilica. There has also probably been another entrance to the first floor rooms of the *domus*. In this way, the new basilica incorporated parts of the *domus*.<sup>343</sup> The southern wall has four possible openings that were blocked, either in the 12th century or earlier.<sup>344</sup> These openings are not included in the reconstruction drawing by Guidobaldi<sup>345</sup>.

---

<sup>342</sup> The wall codes are from Guidobaldi's plans (Guidobaldi 1992).

<sup>343</sup> Guidobaldi 1992, 1, 125.

<sup>344</sup> Guidobaldi 1992, 1, 126.

<sup>345</sup> Guidobaldi 1992, 1, Tav. XVIII and 125.

The excavations have never reached the possible *quadriporticus* of the early Christian basilica. However, there is certain evidence for its existence. The outer pillar line of the narthex continues as L-shaped piers (LQ1 and LQ2), outlining a space. Since Junyent and Krautheimer, there has been a strong belief in the existence of a *quadriporticus*.<sup>346</sup> The 14 pillars that still can be seen within the 12th century foundations are a mixed set of everything possible. They are, at their best, a good example of “spoil architecture” with a range of bases, flute-types and capitals.<sup>347</sup> The foundations for the 12th century church also use the remains of the fifth century basilica and have “swallowed” the columns which have been partly excavated.

The windows exist only as holes and in the present north aisle wall of the 12th century church. The measurements of the windows are ca. 2.10 m in width and ca. 3.25 m in height. The semicircular tops of the openings spread slightly over the opening. The spacing between the windows (most certainly 9 in total for the northern clerestory wall) is 1.90 m.<sup>348</sup> There are also traces of windows that would have been in the short side for the clerestory wall.<sup>349</sup>

Little or no decoration has been found from the 5th century basilica.<sup>350</sup> In the apse wall, there is marble decoration up to the level of 65 cm. At the apse end, there are traces of imitation marble wall painting (*marmo giallo*).<sup>351</sup>

There are no traces of the liturgical furnishings from the fifth century church. The sixth century situation is better known (the *Schola Cantorum* is from the 530s)<sup>352</sup>. The floors were paved with marble fittings.

Guidobaldi points out that the churches architecturally comparable to San Clemente are San Pietro in Vincoli (version A), Santi Giovanni e Paolo and San Vitale, San Sisto Vecchio and Santa Pudenziana.<sup>353</sup>

---

<sup>346</sup> Guidobaldi 1992, 1, Tav. V and XVIII.

<sup>347</sup> Guidobaldi 1992, 1, Tav. VI. “Spoil” means a reused building component from antiquity.

<sup>348</sup> Guidobaldi 1992, 1, 139 and Tav. XVII.

<sup>349</sup> CBRC I, Tav. XX.

<sup>350</sup> Guidobaldi 1992, 1, 139.

<sup>351</sup> Guidobaldi 1992, 1, 140-141.

<sup>352</sup> Guidobaldi 1992, 1, 146.

<sup>353</sup> Guidobaldi 1992, 1, 153-154.

## 4.2 Measurements and reconstructions

Because the necessary data was not available, I took my own measurements in the lower basilica of San Clemente between October 2003 and March 2004 and rechecked 2009-2010. The reconstructions are based primarily on my measurements but I have also used the plans of Guidobaldi, Barclay-Lloyd and Krautheimer.<sup>354</sup> The plan (scale 1:200) and partial sections published by Guidobaldi are very helpful, but not sufficient for creating a three-dimensional model of the archaeological remains. I have also used the plans by Barclay-Lloyd while taking measurements, but due to the nature of her study the plans (ca. 1:200) were not detailed enough to be used for precise modeling.<sup>355</sup> The problem with published plans generally is that the printing process often alters their scale and makes them unreliable.<sup>356</sup>

I used a normal levelling device with a tripod, a laser distance meter (Leica), normal handheld measuring rods, a digital camera (high resolution) and Photomodel 5 photogrammetrical 3D-modelling software. With a combination of old and new measuring methods, a reliable result can be achieved in such complicated and varying circumstances as in San Clemente.<sup>357</sup> The results were then imported into 3D-modeling software, the Autodesk Architectural Desktop 2004/2011. From this data, the reconstructions were created while using the material published by Guidobaldi as a guide to the dating of the various segments of the lower basilica.

The modeling could have been to some extent done using the previously published material but besides questions of accuracy, I strongly believe that to know a building completely, one has to measure it oneself.

In this section I present reconstructions of San Clemente and its surroundings as a basis for the conclusions in Chapter 4. This will be based on existing archaeological evidence and on Chapters 2 and 3 (the typology and the written evidence), which will provide the “lost data” (comparative evidence) in order to arrive at a comprehensive picture of San Clemente around the year 400.

The addition of a *quadriporticus* to the basilica is based on archaeological material and historical sources. It was also considered uncontroversial by both Krautheimer and Guidobaldi.<sup>358</sup>

---

<sup>354</sup> CBCR, Guidobaldi 1992 and Barclay-Lloyd 1989.

<sup>355</sup> With a plan in this context, I mean a measured architectural plan.

<sup>356</sup> The reconstructions were presented as my Master’s thesis at the University of Helsinki (2006).

<sup>357</sup> When taking the measurements, I also had the assistance of student of architecture Petér Paalanen, to whom I remain grateful.

<sup>358</sup> CBCR I, 117-136.



The previous reconstructions were based on the existing northern clerestory wall; by copying it, an impression of the southern clerestory was created. This is quite reliable since its columns exist. The *quadriporticus* is a hypothesis, but there is solid ground for it, since the piers of the narthex pillar line seem to continue in an L-shape, and the literary evidence provided by Gregory (Chapter 1.3), supports the interpretation. The size of the *quadriporticus* is more problematic. The narrowing factors are the outer southern and northern walls of the basilica, and the existence and placement of the street. As the basilica and the earlier basilical building have followed the load bearing structures of the *horrea*, it would be possible that the fifth century basilica also did the same. The problem is that the eastern wall of the *horrea* is unknown. It has been assumed that the *horrea* was symmetrical. The stairs of the *horrea* have been excavated, thus making the reconstruction based on the hypothesis of a symmetrical building possible. This hypothetical *horrea* would measure 100 RF×220 RF. According to this logic, the length of the fifth century basilica would equal the length of the *horrea* plus the fire alley and the apse.

The previous reconstructions are not detailed, and there are no explanations of why specific decisions were made. I shall endeavor to explain my choices between archaeological, written or comparative evidence.

The reconstructions are experimentally divided into three stages. The first phases of the reconstruction present the archaeological evidence. The reconstructions of stage II (plans, sections and elevations, Drawings VI and VIIa-d) show the existing archaeological evidence and the reconstruction lines are clearly marked in order to compare these with the evidence itself. These rely mostly on the archaeological evidence itself, but also a good deal of comparative material has been used from contemporary basilicas, mainly in Rome. Since there is a lot of similarity, almost a standardized early Christian basilica presented in Tables I and II, this comparative material is well justified.

Stage III, sometimes also called the “Artist’s View” is the part based on the Stage II reconstructions (the more technical plans and sections). Stage III (Drawings VIII, IX, Xa, Xb and Xc) is an attempt to give the reader an idea of what the building might have looked like. The Stage II provides the basis for this attempt, with the missing data provided by the comparative studies discussed below, as well as contemporary written evidence. This evidence – the descriptions of Paulinus Nolanus, Sidonius Apollinaris, the inventory lists and the liturgical descriptions – provide clues for the furnishings and decoration (silver chandeliers, curtains, mosaics, paintings, etc.) of an early Christian basilica.<sup>359</sup>

The 1:2000 site plans for the surroundings are based mainly on Lanciani, Colini,

---

<sup>359</sup> Paulinus *Ep.* 32, see also Appendix II.

aerial photographs and old maps – mainly Giovanni Battista Nolli's map of 1748.<sup>360</sup> The site plans (Drawings I-V) cover an area of 500×250 m (1/8 square kilometers or two 250×250m squares, Maps III and IV). The excavations of the site are well recorded, and I have gathered them into a simple map, thus showing the existing structures of the early fifth century. These site plans are linked by the grid of 250×250 m squares to the larger maps showing the entire city.

Drawing I shows the current situation with the street names and the location of San Clemente. The edge of the Colosseum is located on this site plan, as well as the excavated ruins of the Ludus Magnus. The site plan was drawn from a 1:10000 aerial photograph of Rome that was taken in 1999. Drawing I showing the current situation is important for comparability to the other drawings of same scale.

Drawing II shows the excavated archaeological sites. The site plan is based on Colini's site plan of the 1960s.<sup>361</sup> This plan, however, is missing a lot of information, but it was reused in the 1990s by Guidobaldi.<sup>362</sup> The main problem is that Colini's plan disregarded Lanciani's information regarding the archaeological evidence from the Via Labicana. Drawing II also shows the previous hypothesis of the surrounding topography from the Severan Marble Plan (FUR). I have also added the street line (dotted line) between the Ludus Magnus and the Colosseum, based on the assumption that the structure of the Ludus was symmetrical, and the possible canvas anchoring poles (ca. 160 in total) surrounding the Colosseum, thus leaving a street of a width that corresponds with the other street widths in the surrounding area. The other street lines are based on the archaeological evidence and the Nolli Map of 1748 (Drawing III).

Drawing III is a digitized version of the Nolli Map of 1748. The reason why this map is so important when discussing the site plan of San Clemente is that it is very rich in detail and represents the utmost accuracy for its time. When I digitized the map (AutoCAD), I noticed that its accuracy was within 5 meters in an area of 1/8km<sup>2</sup>. The map shows the situation after Sixtus V's remodeling of the city, when the surroundings of San Clemente were still mainly vineyards. The streets correspond with the streets on earlier maps done at the end of the 15th century, and are accurate to some extent. The modern streets, such as the Via Labicana and Via dei SS. Quattro Coronati, correspond with the archaeological evidence found at the site (the new 19th century streetgrid sort of reproduced the antique). The Nolli Map with the excavations of the site thus provides valuable information for the site plan of the fifth century.

---

<sup>360</sup> See Chapter 1.2.

<sup>361</sup> Colini 1962.

<sup>362</sup> Guidobaldi 1992, Tavolva II.

Drawing IV is a combination of the Nolli Map and Drawing II, preparing the ground for the reconstruction site plan (Drawing V). The archaeological remains along the Via S. Giovanni at the Colosseum end would thus correspond well with the previous assumption of the size of the Ludus Magnus. This estimation with the excavated streets in combination with the Nolli Map is also true for the streets by the Ludus Dacicus, with the north-south street on the south side of the Ludus Magnus and with the street climbing the Oppian Hill.

Drawing V shows the reconstructed site plan of the fifth century. The Colosseum was still in use, although gladiatorial games had ceased. The smaller Ludi were also in use, although to be abandoned very soon. There is no reason to believe that the area was abandoned, and that the surroundings of San Clemente would not have been in use, although not in their original function. The different hatches on the blocks show the approximate density of the urban topography, and the state of our knowledge of the function, or form, of the buildings, as well as my hypothesis of the surroundings.

At the beginning of the fifth century, the urban topography was still very dense. The slow degeneration of the city began a couple of decades later. The site was on the outskirts of the city – but still within the walls. The remains of the *tabernae* along the Via Labicana indicate a lively picture of the district, and the site was still “the amusement park” of late antique Rome, which made the site of San Clemente more attractive – if one wants people in a church, place it where people go. It was a very simple placement strategy indeed.

Drawing VI shows my own measurements of the site, and the information provided by Federico Guidobaldi and Richard Krautheimer. The plan, compared with that of Guidobaldi, shows the structures that existed at the beginning of the fifth century and that were incorporated into the structure of the basilica. It also shows the other structures, pavements etc. but they are not highlighted on this plan, in order to make the reconstruction of the fifth century basilica easier. The other features are the dotted lines which show my hypothesis. I have made some changes to the previous reconstructions by Krautheimer and Guidobaldi, which are dealt with below.

The floor level of the basilica is uncertain. Federico Guidobaldi places it at a level of +24.65. This seems to be the level at the entrance to the building, but the floor rises towards the apse, and it is difficult to get an accurate reading of the level. Guidobaldi suggests that this was in order to get water out of the basilica (when, for example, washing the floors) but the difference between the levels is too great for this purpose, and unpractical. I suggest that the apse end, meaning the level between the apse (+25.50) and the first pillars, was raised, as in the church of Paulinus Nolanus, discussed above<sup>363</sup>. This would

---

<sup>363</sup> See Chapter 3 and Lehmann for the reconstructions.

correspond to the other contemporary basilicas. According to Paulinus, the altar was placed in the apse and was thus the focal point of the interior. The pictorial development of the mosaic program also culminated here, in the triumphal arches adorned with themes from the New Testament.<sup>364</sup>

Since the *quadriporticus* still remains unexcavated, we can only make assumptions. My version of the *quadriporticus* follows Krautheimer, but I have placed the columns in a similar way to those of the narthex. This creates the *polifora* (with the larger middle arch) that was left out of Krautheimer's isometric reconstruction (Fig. 1.1.03). The gatehouse also follows the conjectured outlines of the *horrea* (according to the assumptions presented above regarding its dimensions). The difference is that the western end (next to the street) follows the outlines of the present gatehouse. These can be seen clearly on the Barclay-Lloyd plan of the present San Clemente. The outer walls of the present gatehouse seem to correspond with the outer walls of the *horrea*, while the other medieval walls are less so.

I have also shown the stairs of the earlier *domus*. Guidobaldi thinks it highly possible that the lower level of the Mithraic temple was used during the fifth century. From this it would follow that the stairs would have been housed somehow within the older structure, as is the case with the "sacristy" on the northern side, thus making the basilica symmetrical.

In these reconstructions, I also assume that there was a street or alley on the north side of the basilica that was incorporated into the basilica in the sixth century, when the baptistery was built. The problem of the baptistery still remains since it was a vital part of a basilica during the fifth century, but where if anywhere was the baptistery in the 5th century.

The supplementing structures, such as roof trusses etc., I have added without any archaeological evidence. The distance between the trusses would be 1200 mm (ca. 4RF). These would have been made out of tree trunks of a width of 1RF. The windows are quite well known but the frames are unknown. The height of the windows according to Guidobaldi, would have been at least 3.25 m, but I have set the height at exactly 3.25 m because otherwise they would extend too far downwards, causing the roofing of the aisles to be at an angle in relation to the roof of the nave. Like Richard Krautheimer, I have chosen to model the roofing of the aisles and that of the narthex as a continuous structure, diverging however from his model by also situating the roof of the gatehouse on the same level. This causes the north and south flanks of the atrium to be lower, still retaining the appearance of a *quadriporticus*.

---

<sup>364</sup> Santa Maria Maggiore also possesses this feature.

The Phase II reconstruction more or less follow the guidelines of the reconstructions of Richard Krautheimer and Federico Guidobaldi (with the exception of the floor level, atrium and the stairway to the Mithraic temple). The new part would then be the Phase III reconstructions – the 3D perspective models of the basilica that are based on the Phase II reconstructions (Drawings VIII, IX and Xa, b, c). As already stated above, the written evidence for contemporary basilicas, especially the descriptions by Paulinus Nolanus, will become an integral part of the Phase III reconstructions, with the comparative material from other contemporary Roman basilicas.<sup>365</sup>

When the Phase II reconstructions were modeled according to the comparative material from the later discussed typology (Chapter 2), the literary evidence and some other comparative material come into the picture. Since the building skeleton already exists, the basilica is completed with material otherwise missing.

The perspective drawings (Drawings VIII, IX and Xa, b, c) are the most hypothetical of the reconstructions. Drawing VIII shows San Clemente with an axonometric view and Drawing IX shows San Clemente as seen from the *quadriporticus*. Drawings Xa, b and c are divided into three different sequences. Drawing Xa shows the nave with permanent fixtures, such as the altar and window lattices, which come from the comparative evidence.<sup>366</sup> Drawing Xb shows the nave with mosaics and decorations. The mosaics are original mosaics from S. Sabina (modified), S. Maria Maggiore (the panels) and San Clemente itself. The apse has been adorned with *opus sectile* similar to that of Cimitile (Nola), but is in reality from Ostia (Porta Marina, Museo dell'Alto Medioevo, Rome). The last version, Drawing Xc, shows the interior with hypothetical curtain installations and brings out a very different nature of the interior of the nave.

I have chosen to represent the façade as plastered (Drawings VIII and IX). There is no evidence for this, but since Paulinus has described his basilica as plastered and since there is archaeological evidence for this, it is probable also true for San Clemente. The color I have chosen is white. For the exterior, I have chosen window lattices on the model of those of Santa Sabina, a very common model for the late antique period, which has also been chosen for the restorations of Santa Sabina and Santa Balbina in Rome.

In the interior many of the choices become more complicated (Drawings Xa, b and c). Since there is virtually no trace of the floor pavement, I have chosen a typical pavement of the period, a set of triangular-shaped marble slabs of different kinds, to form the basic

---

<sup>365</sup> Paulinus *Ep.* 32.

<sup>366</sup> The lattices were designed for Santa Sabina in the 1920s according to the archaeological evidence from site.

unit of an *opus sectile* (60×60cm) flooring.<sup>367</sup> The missing columns have been chosen to continue the plurality of the reused *spolia* material. The models for the *opus sectile* and mosaics, see Fig. 4.2.01.-4.2.12.

The curtains, mentioned several times in the inventory lists of testaments by private individuals, and pictured in the famous Ravenna mosaics (or the mosaics in Louvre), have also been added (Drawing Xc). The columns have traces of attachments of some kind.<sup>368</sup> Guidobaldi and his predecessors have discussed the asymmetry of the reused columns, and have come to the conclusion that the columns follow a rhythmic order of some kind. My theory is that the columns were secondary since the curtains were to separate the catechumen from the congregation during the Eucharist and, thus, the columns would not have been completely visible. Whether they were open or closed, the columns would have been partly covered since the traces of fixtures for hanging are on the nave side of the pillars and not on the aisle side. This is a theory that requires more discussion of the appearance of the early Christian basilica interiors.<sup>369</sup>

The problem of the ceiling is very hard to solve. In his reconstruction of the basilica in Nola, Tomas Lehmann has chosen open trusses. If the ceilings had been coffered, they would not have left any traces since the material would have been wood and thus either rotted away, was replaced or torn out since they were attached (as up to the present) to the trusses and not to the walls. However, there are descriptions of gold and silver gilded coffered ceilings from that time. The problem is that these probably were only in the more important basilicas.

The placement of the altar is also problematic since there are no traces of it. I have chosen the Lehmann-version, which was based on the description of Paulinus<sup>370</sup>. The sconces are attached, according to Lehmann's reconstructed version, to the columns themselves, with the addition of a chandelier in the apse. The location of the apse is supported by evidence from other Roman basilicas, such as St. Peter's.<sup>371</sup>

<sup>367</sup> Guidobaldi 1983. Guidobaldi's study offers the most comprehensive study of late antique flooring yet to date and has also been used for this dissertation.

<sup>368</sup> Guidobaldi 1992, Tav. VI.

<sup>369</sup> There are several representations of curtains hung between pillars in late antique art. See Weitzmann 1979, 31-32, 78-79, 200, 330-333, 597 and 609-610. The famous Ravenna Mosaic from Theodoric's palace also shows curtains hung between the pillars (Morey 1953, fig. 176). Milburn dedicates a chapter to early Christian textiles, but does not discuss their functions in liturgical contexts. However, he mentions the description by Paul the Silentiary, of the curtain covering the ciborium at Hagia Sophia.

<sup>370</sup> Paulinus *Ep.* 32. In Lehmann's reconstructions, the vivid description of the chandelier in the apse is emphasized in Drawings Xa, b and c by a single source of light placed in the same way. Naturally, there would have been more sources of light, but these are not presented here for practical reasons.

<sup>371</sup> De Blaauw 2001, 969-991. At St. Peter's, the altar was also placed in the apse and the level of the apse was raised with steps coming from the nave. The model for the reconstructions for the altar placement was taken partly from the excavated basilica of San Alessandro by the Via Nomentana in Rome. The altar

The pictorial program of San Clemente also poses problems. Since there are no traces, except some evidence of painted decoration, the reconstruction is highly hypothetical. However, since there is so much comparative evidence, as well as rich descriptions by Paulinus, we can say with confidence that there were pictorial representations with both Old and New Testament themes in San Clemente. For this “Artists View”, I have chosen the same scheme as in Nola or in Santa Maria Maggiore – Old Testament themes on the clerestory walls and New Testament themes in the triumphal arch. The clerestory wall pictures would probably have been painted and the triumphal arch and apse adorned with mosaic. Paulinus gives us a description of his clerestory wall in his basilica in Nola: *The whole area outside the apse of the basilica extends with high-panelled ceiling and with twin colonnades running straight through an arch on each side. Four chapels within each colonnade, set into the longitudinal sides of the basilica, provide places suitable for those who privately pray or meditate on the Lord’s law, and for the funeral monuments of the clergy and their friends so that they may rest in eternal peace.*<sup>372</sup> The theme of the triumphal arch is the same acanthus motif as in the present San Clemente. Lloyd has pointed out that it would be possible that the present apse mosaic might have been partially transported from the Lower Church.<sup>373</sup> The Lateran baptistery also displays the same acanthus motif, and since the churches built after the Gregorian reform took a substantial amount of their influences from early Christian architecture, the reuse of the acanthus motif would make sense – at least in theory.

---

is similar to the altar used by Lehmann in his reconstructions with stone carving themes.

<sup>372</sup> Paulinus *Ep.* 32.12.

<sup>373</sup> See Thümmel 2002, 1725-1738 on the acanthus motif.



Fig. 4.2.01. The baptistry in the Lateran with the acanthus motif dome and the flanking *opus sectile* decorations. Both of these motifs are used in the reconstructions in Chapter 4.



Fig. 4.2.02. The baptistry in the Lateran with the acanthus motif dome, detail.





Fig. 4.2.03. The baptistery in the Lateran with the *opus sectile*, detail.



Fig. 4.2.04. The recently reconstructed floor paneling of Santo Stefano Rotondo in Rome.



Fig. 4.2.05. The flooring of Santa Maria Antiqua in Rome.



Fig. 4.2.06. The Arian baptistery in Ravenna showing the combination of acanthus scrolls and *opus sectile*.



Fig. 4.2.07. The Arian baptistery in Ravenna showing the *opus sectile* decoration.



Fig. 4.2.08. The Arian baptistery in Ravenna showing the *opus sectile* decoration.



Fig. 4.2.09. The mausoleum of Galla Placidia in Ravenna showing the acanthus-motif.



Fig. 4.2.10. Paulinus' Basilica Nova in Cimitile showing the remaining *opus sectile* in the apse.



Fig. 4.2.11. Paulinus' Basilica Nova in Cimitile with the remaining *opus sectile* in the apse. Detail.



Fig. 4.2.12. Domus dell'Opus Sectile in Ostia (Porta Marina) and the *tablinum/aula/exedra* of the house in the Museo dell'Alto Medioevo in Rome. Detail.

## 4.3 Conclusions

Looking back at the reconstruction of the fifth century basilica, the question remains in what way does my work contribute to the understanding of the history and development of San Clemente? First of all, it provides a hypothesis for the transformation of a *domus* into a basilica, thus joining two different lines of architectural development into one - that of the typology of the basilica and that of the late antique *domus*. Secondly, it offers more detailed reconstructions of an early Christian space in sequences with detailed documentation, which has not been done before. Thirdly, it also gives a broader architectural view on the development of the Roman *Sakraltopografie* in the 4th and 5th centuries with maps and tables that have not been produced earlier.

So far, I have briefly described the development of the basilica as a building typology with its variations, in Rome and in the Mediterranean world (Tables I, II, III and IV and Maps I, II, III, IV and V). Chapter 1's archaeological and written evidence, combined with the previous studies on the subject and the first chapter's material, resulted in the reconstructions of San Clemente in the early fifth century. In this chapter, I compare these results with the typological development outlined in the first chapter.

For the questions presented in the Introduction, I would state that the reconstructions are made according to *The London Charter*. Is it possible to prove that Phase IVb existed? No. However, there is a good chance it did and probably further excavations would prove it. We have to remember that the site is only partially excavated.

Did the Roman *domus* have influence on the Roman church building in the fifth century? Yes. For sure since, architecturally, a new function ( a church) is added to an existing context (a *domus*), the answer is quite clearly yes. The short period of open flowing space can be traced to a *domus* in general. both in literary and archaeological evidence. It would be easier to make an architectural connection between a *domus* and a basilica in late antiquity than in the Medieval period (or Renaissance, Baroque or modern). Even if 50% probability does not guarantee or verify my proposed building chronology, Table IV shows that it would be far more rare for San Clemente's earlier phase to have been a barrack or an insula - and it was most certainly not a public building in the modern sense.

Concerning the disagreement among scholars about the function of the third century building phase (Phases IV and IVb), I would suggest the following simple scenario: After the demolition of the upper story of the *horrea*, a *domus* was built on the site and it was connected with the adjacent property with the *Mithraeum*. Guidobaldi's remarks on the rich interior design point more in the direction of a private building project than one for industrial purposes, as Coarelli proposed. This annexation would have produced a *domus*

of a great size, but not abnormal in late antique Rome. The annexation is very speculative, but still possible and would well fit with the late antique expansion of the Roman *domus*. After combining both properties, the Mithraic cult ceased to exist on the subterranean floor (the lowest level).

The *quadriporticus*, an essential feature in many Roman churches, as was the peristyle in the *domus*, lasts only for a century in Roman architecture. The openness of the *polifora* or *narthex* between the two spaces has a short lifespan and will be built in Rome only twice after the 5th century, in Santa Prassede and SS. Quattro Coronati. Of course, the porticoed space will continue its life in Europe as the cloister, but it is not the same thing since it does not precede the entrance to the basilica in a monumental way. The Medieval cloister is a more closed and private space by nature. All in all, the *polifora* has been mentioned marginally in research, but the peristyle's influence on Roman church architecture remains to be studied in detail in the future.

After Constantine, the *domus* included a space for Christian worship, quite possibly belonging to a man of high status named Clemens. This would go along the lines presented by Kim Bowes, who argues that the nature of Christian worship by the patrician classes was more private and took place in a *domus*, but not completely privately, as I have already mentioned when discussing the private and public nature of the *domus*. The *domus*, with the addition of the *aula* might also have comprised a peristyle garden, as was common in an urban *domus* of this size (the highly speculative Drawing XII of Phase IVb). At some point during the late 4th century, the Domus Clementis passed slowly under the control of the Bishop of Rome but still retained its autonomy to a degree. The Titulus Clementis now had a more public role in the city of Rome and was used more or less like the other *tituli*. Sometime at the end of the fourth century, the Titulus Clementis was found to be too small since the place of worship was basically only an *aula* in a patrician *domus*. As the *titulus* endowments, which financed the upkeep of the *titulus* and its presbyter and clergy, were found insufficient, the Bishop of Rome financed a rebuilding on a grander scale, thus diminishing the autonomous role of the fourth century privately funded *titulus*.

Later, there was another annexation under presbyter Mercurius (John II) by claiming the other *domus* on the north side of San Clemente and converting it into a *secretarium* and baptistry. Finally, the *translatio* of the relics of St. Clement in the ninth century puts St. Clement actual at San Clemente and completes the circle.

## 5. Appendix I

Paulinus Nolanus, Letter 32

*Letters of St. Paulinus of Nola* (ed. P. G. Walsh), Vol. I & II, Newman Press 1966, New York.

To Severus

1. When I had enclosed those poor verses, the open page made advances to my tongue and hand to fill out the empty spaces, and it struck me that I had something to write. I am highly delighted that we have together exhibited the one appearance of heart and body, and of works and dedications as well, by simultaneously bestowing basilicas on the Lord's folds. But you have also constructed a baptistery between your two basilicas, so that you surpassed me in the erection of visible buildings as well as invisible works.

I thank the Lord, however, that he has granted me even defeat as victory. For when I am surpassed in grace by him whom I set before myself in esteem but on a par with myself in love, I prevail in my prayer. You are the one of whom I speak; you, I say, are the greater and better part of me. You are my rest and joy. You are a pillow for my head, and a dwelling for my mind which I hope and trust in the Lord will remain accessible to me not merely in this life but also forever, through His gift and His body and spirit. So should you achieve anything considerable through the grace of the Lord, you do it assuredly in company with me, and certainly on my behalf.

2. But here I am afraid that through your love for me, of which I regularly complain, you may set a rough stumbling block amongst your works, by which you level the steep paths and make straight the crooked ways of the world. For you seek to tarnish the gleaming inscriptions of your dedication in Christ with my name, and to set my wickedness amongst your toils of righteousness, so that you desecrate even your holy place with the countenance of the wicked. It is right that Martin should be portrayed in that place of renewal for men, for he bore the image of the heavenly man by his perfect imitation of Christ; so when men lay aside the old age of their earthly image in the baptismal font, the portrait of a heavenly soul worthy of imitation should strike their eyes. But by what right am I there, since I cannot match the innocence of children or the wisdom of men, and since I am distinguished from spotless souls by my wickedness and from perfect ones by my weakness? For what fellowship hath light with darkness? Or wolves with lambs? Or serpents with doves – a true comparison of myself with Martin? Have you not mingled milk with gall?

However, there is a good side to this. When men are set in the same place they are not



mixed with each other like liquids in a cup. If they differ in their deserts, the sweetness of the good man is not poisoned by the bitter taste of the wicked one. On the contrary, the sinner when associated with the just man appears fouler, while the just man in comparison with the other shines more brightly. For this reason I am less troubled by your fault of affection, because you have done no wrong to be blessed Martin, but rather added to his glory; for you have set his revered portrait facing my contemptible countenance, so that by comparison with my darkness, his brilliance, gleaming with outstanding radiance even in the brightness of the saints, might shine forth all the more brightly.

Indeed, If did not know that you had this portrait done through the great zeal of your excessive love for me, I would charge you with devious malice. I would have said that by depicting me close on the opposite wall, you had contrasted my lowly figure shrouded in mental darkness with Martin's holy person; and that by so doing, you had painted only him and done a caricature of me, exposing me to merited contempt once Martin's countenance is sighted, and demonstrating the heinousness of this absurd comparison.

3. But I do not wish to cause this idea of yours, which springs from your love, to incur the laughter it can and should provoke, merely because your great love for me deceives you and will lead you to express falsehood. So for this reason only I have obeyed your demand, and have sent some modest verses describing such a picture as yours is. These verses can reveal your design. For you were eager to give a healthy formation to the persons renewed by baptism, so you paced before them two completely different portraits, in order that on leaving the sacred font they might simultaneously see the exemplar to avoid and the model to follow. So here are my lines to use if you like them:

“All you wash your souls and bodies in this font should behold the paths set before you for good deeds. Martin is here so that you may see a model of perfect life, whereas Paulinus schools you in how to merit forgiveness. Martin should catch the eye of the blessed, Paulinus of sinners. So Martin must be the example for the saintly, Paulinus for the guilty.”

Or again, on the same subject:

“Severus, so rich in wealth lavished on Christ and so poor in that devoted to himself, here sets this fine roof over the consecrated waters. He built this shrine for the works of heaven, so that here men may be refashioned by water and by God. So he has adorned it, making it worthy of the sacrament, by painting twin portraits above, so that when men attain new birth they may learn of the gifts of life. One man's revered portrait bears witness to Martin; the other represents the lowly Paulinus. Martin arms our faith by good example and courageous words, so that our faith may be unsullied and win the palm of

glory. Paulinus redeems his sins by casting away his pence, and so reaches us how our possessions are of less account than our salvation.”

4. It will be a certain proof that you are to be the object not of laughter but rather of approval, if only you are shown to have painted cheek by jowl these wholly different persons from one motive only. This would be to make manifest in Martin the shape of right living and the aggregate of virtues, and in me contrition for an admission of my conscious guilt; in other words, to exhibit a model both for the blessed and for the wretched, so that in Martin courage can be mirrored and in me cowardice may find consolation. So those who are able to fulfill virtuously God’s command may look on Martin, while those who aspire to remedy their sins may be consoled through me. For only redemption can assist those of us who like captives are tied with the bonds of wickedness and stripped of the confidence of innocence.

I beg you, however, not to turn my obedience into sin by removing those verses of yours, so filled with light and redolent of the honeycomb, as you threatened to do. I pray that your threat may betray modesty rather than true intention. If you think that my verses should be added, let yours remain to sparkle like gems amongst mine, giving value to what is cheap and adoring blackness with brightness. I indeed accepted the free hand you offered me. I told my tongue not, as the proper bids, to preserve its rest and take heed to its ways, but rather to burst its protective bridle, provided that it was ministering to you. I love you so deeply that I feared more to sin through disobeying you than through excess of words.

5. So I have also written some little verses for your basilicas like votive inscriptions for sacred fountains. If any of my lines shall seem apposite, the credit for this, too, is brother Victor’s, for it is through his eyes and words that I have witnessed all that you have done and continue to do in Christ the Lord. So you will assess these additional verses which I have inserted about the basilicas as written by him, for he dictated the contents by telling me of your works. The following lines will describe the baptistery, for the previous ones described only the murals there.

“Here the spring which fathers newborn souls brings forth water living with divine light. The Holy Spirit descends on it from heaven, and mates its sacred liquid with a heavenly stream. The water becomes pregnant with God, and begets from seed eternal a holy offspring in its fostering fount. Wondrous is God’s fatherly love, for the sinner is plunged into the water and then comes forth from it justified. So man achieves a happy death and birth, dying to things earthly and being born to things eternal. His sin dies, but his life returns. The old Adam perishes and the new Adam is born for eternal sway.”

“Severus, most chaste of Christ’s dwellers in body, mind, and faith, has in joy built this house for God. He is himself wholly a temple of God, and thrives with Christ as his guest, bearing in humble heart the glad Lord. And just as he worships one Mind under three names, so here he has dedicated a threefold work of sacred building. On the twin structures he has set for his people splendid roofs so that their number might harmonize with the sacred Laws. For just as the one Proposer stipulated two Testaments, joining Christ with God in the one faith, so Severus has set his baptistery with tower-shaped dome between two churches, so that Mother Church may joyfully receive in twin bosoms the newborn offspring brought forth by water. The twin-roofed basilicas represent the Church with two Testaments; the single baptistery lending grace adjoins both. The Old Law strengthens the New, the New fulfils the Old. Hope lies in the old, Faith in that which is new. But Christ’s grace combines Old and New, so the baptistery is placed between the two. From it the priest our father raises from the consecrated water children snow-white in body, heart and dress. These novice-lambs he leads round to the festive altars, and introduces their uninitiated mouths to the Bread of salvation. Here the crowd of elders, a gathering of friends, shares the rejoicing. The fold bleats in fresh chorus: Alleluia!”

6. After I had written these verses to celebrate the handiwork of your dear self, I could not leave unmentioned that which is made by no hand, the grace of God in your church. By that grace He bestowed Clarus on you as permanent guest in your church. So I presumed to write some verses to his holy memory, not because I could say anything worthy of his godlike merits, but to express my eager and abundant love for his godlike merits, but to express my eager and abundant love for his soul. These verses I now boldly send to your affectionate person. When you read them out, in the Lord’s presence, to this holy soul who lodges forever with you in the Lord, you must excuse my recklessness and praise my obedience.

“Clarus the priest is clothed in that inner light which reflects his name. His mortal body lies in the tomb. But his mind, freed from the prison of the body, finds joy amongst the stars, for its purity has gained the haven of the holy men who are approved. His sacred bones are at rest beneath the eternal altar; and so when the chaste gift of Christ is devoutly offered there, the fragrance of his soul may be joined to the divine sacrifice.”

Here are more verses on the same subject, so that you may select those you prefer. But I know that in this matter your hesitation ought to be prompted not by choice of particular verses for the inscription, but by the necessity to do no injustice to any of God’s saints.

“A priest lies here, Clarus by name and famed by his merits, Martin’s companion in mediation and now his partner in praise. The altar is a worthy home for this devoted man

now dead, whose limbs lie beneath it. But his spirit rejoices in the upper air. Above the stars, he shares with the Master he resembles his disciple here below.”

“Clarus, renowned in faith, highly renowned in deeds, most renowned in your harvest, your name is reflected by your merits. It is right that a pure altar covers your body, so that God’s altar may conceal the temple of Christ. But you are not restricted to the abode where your body lies, for your spirit flies to the reward you have merited above. Whether you lie in the bosom of our fathers, or feast in a sacred grove – wherever, Clarus, you are set in heaven or Paradise, you live happily in eternal peace. In your kindness receive these prayers of sinners who ask you to be mindful of Paulinus and Therasia. Love these persons entrusted to you by the mediation of Severus, though when you were here in the flesh you were unaware of their merits. Let the love of a friend held in common kindle in both of us an eternal covenant in the highest Lord. You cannot separate men who are united; should you seek to drag away one, he will draw to his forced destination those who cling to him. So embrace Severus and Paulinus together as brothers indivisible. Love us and join with us in this union. God summoned us together, Martin loved us together. So, Clarus, you must likewise protect us together. Our equality lies not in merit, but in love, but, you, holy Clarus, will be able to ensure our equality also in merit, if you become Martin’s partner in the toil of paternal love, so that your prayers may prevail over my sins. So I may attain the destiny of Severus, and your wing may ever protect me in its folds.”

7. Doubtless the Lord has through your faith granted your heart’s desire by enhancing the beauty and holiness of your buildings through your acquisition of sacred ashes from the holy remains of glorious apostles or martyrs. I know that it was in expectation of this favour that you have built our second basilica, bigger than the first, at the village of Primuliacum. Yet I think it worthy of the work of your faith, and of the dedication of that building now faithfully completed (which I am sure huge crowds attend), and also appropriate to the relics of the saints, that you should also venerate that fragment of the cross which I sent, and which lies consecrated in your church in company with the relics of the saints. If you decide to do this, these little verses will announce your decision:

“The revered altar conceals a sacred union, for martyrs lie there with the holy cross. The entire martyrdom of the saving Christ is here assembled – cross, body, and blood of the Martyr, do Himself. From God preserves His gifts for you forever, and when Christ is, there also are the Spirit and the Father. Likewise where the cross is, there, too, is the Martyr; for the Martyr’s cross is the holy reason for the martyrdom of saints. That cross has won for men the Food of life, has won also the crowns which gain a portion with the Lord for His servants. The flesh which I eat was nailed to the cross; from the cross flows that blood by which I drink life and cleanse my heart. Christ, may these gifts of Yours

unite with Your Severus. May he bear your cross and witness to it. May he live on Your flesh; may Your blood provide his drink; may he live and work by Your word. Through Your kindness may he be borne on that upward journey on which he beheld Your Martin and his companion Clarus rise.”

8. But you may desire to have this blessing from the cross available for your daily protection and healing, and once it is buried within the altar in may not be always accessible according to the need. In that case it would be a sufficient grace for the consecration of the basilica if we entrusted it to the apostles and martyrs. If their revered ashes are stowed beneath the altar unaccompanied by the cross, this superscription will reveal that they are hidden there:

“The splendour of God’s table conceals those dear relics of the saints which have been taken from the bodies of the apostles. The Spirit of the Lord hovers near with healing powers, and demonstrates by living proofs that these are sacred ashes. So twin graces favour our devoted prayers, the one springing from the martyrs below, the other from the sacrament above. The precious death of the saints assists, through this fragment of their ashes, the prayers of the priest and the welfare of the living.”

9. Here, then, are your verses. They are unworthy of your holy and splendid buildings, yet they accord with that conviction about me which you prefer to trust rather than me. If you have no shame in inscribing them on the public walls of your church, I shall have my revenge. For I believe that you will repent of your wish you extorted from me, once you behold, pink with embarrassment, your immaculate buildings, as yet gleaming with the spotless beauty of your labours, darkened and – to use an expression worthy of my verses – befouled by my lines of childish ignorance which will provoke many laughter and disgust. You must not strain to deceive people so that the reader may think that you have written the verses; and since their ineptness, which no one associates with you, can inform the reader, he must not put the blame for my poems on to you, though you should incur censure as publisher or scribe.

But I should not like anyone to judge me a transgressor of that law which enjoins never do to another what thou dost not wish for thyself. So you will have proof, by the evidence which lies before Victor’s eyes, that my own basilica endured the same treatment from me before yours. So you can show our inner unity additionally by the fact that by compliment or insult I compared myself with you and sinned against your basilicas only as rashly as I did against my own.

But you must regard our Victor as the author or as the guilty one – the author of what your most indulgent attitude to me regards as a favour, or the one guilty of injustice if

one contemplates my most unworthy gift. For Victor, that most holy spokesman of our love, assumed that your pleasure on seeing him back from me would be greater the more bent he was on his return under the unjust burden of the trifling verses I send you. For he desired to add to his load by carrying inscriptions and sketches of my basilica to show to you. And he will be justified if on his arrival, weary and bent, he utters his complaint: "Behold, for the sake of the commands of my lips I have kept hard ways. The wicked have wrought upon my back; they have lengthened their iniquity to the extent of all these letters."

10. So I have thus accumulated my sins by bestowing the injustice he sought upon our brother, who was most eager for this burden so that his soul might be lightened by the affliction of his body. For this demand of his, by which he maintained that new buildings in the Lord ought to be made known to you as you had desired to reveal yours to me by inscriptions and paintings, seemed to be truly in keeping with our unity of purpose. So this motive has induced me to interconnect my basilicas with yours not only by their simultaneous construction and the fashion of their dedication, but also by describing them by letter. So in this additional way the fusion of our minds, however remotely we are separated, may be symbolised; and though these buildings, which in the same spirit we have toiled at and erected in the Lord's name, are separated and far distant from each other by a chain of letters.

Well then, the basilica, now dedicated in the name of Christ our Lord and God to our common protector and lord puff our house, is thronged as an addition to his four basilicas, and is venerable not merely through the respect paid to the blessed Felix but also because of the consecrated relics of apostles and martyrs kept under the altar in the tripartite apse. A vault adorned with mosaics provides light for the apse, the floor and walls of which are faced with marble. These are the verses which describe the scene depicted on the vault:

"The trinity shines out in all its mystery. Christ is represented by a lamb, the Father's voice thunders forth from the sky, and the Holy Spirit flows down in the form of a dove. A wreath's gleaming circle surrounds the cross, and around this circle the apostles form a ring, represented by a chorus of doves. The holy unity of the Trinity merges in Christ, but the Trinity has its threefold symbolism. The Father's voice and the Spirit show forth God, the cross and the lamb proclaim the holy victim. The purple and the palm point to kingship and to triumph. Christ Himself, the Rock, stands on the rock of the Church, and from this rock four plashing fountains flow, the evangelists, the living streams of Christ."

11. On the girdle below, where an inserted ridge of plaster joins or separates the borders of wall and vault, the following superscription reveals the holy of holies which has been

set beneath the altar:

“Here is reverence, and fostering faith, and Christ’s glory; here is the cross, joined with those who witnessed to it. For the tiny splinter from the wood of the cross is a mighty promise. The whole power of the cross lies in this small segment. It was brought to Nola by the gift of holy Melania, this greatest of blessings that has come from Jerusalem. The holy altar conceals a twofold honour to God, for it combines the cross and the ashes of the martyrs. How right it is that the bones of holy men lie with the wood of the cross, so that there is rest on the cross for those who died for it!”

12. The whole area outside the apse of the basilica extends with high-panelled ceiling and with twin colonnades running straight through an arch on each side. Four chapels within each colonnade, set into the longitudinal sides of the basilica, provide places suitable for those who privately pray or meditate on the Lord’s law, and for the funeral monuments of the clergy and their friends so that they may rest in eternal peace. Each chapel is designed on the front of the lintels by a couplet which I have not wanted to quote on this letter. But I have jotted down the lines inscribed on the entrances to the basilica, because if you wished to adopt them they might be suited to the doors of your basilicas. For example:

“Peace be upon you who enter the sanctuary of Christ God with pure minds and peaceful hearts.”

Or this, taken from the representation of the Lord over the entrance, the appearance of which the lines describe:

“Behold the wreathed cross of Christ the Lord, set above the entrance hall. It promises high rewards for grinding toil. If you wish to obtain the crown, take up the cross.”

The following verses are found at a more private door to the second basilica, where there is what I might call our private entrance from the garden or orchard:

“Christ’s worshippers, take the path to heaven by way of his lovely sword. An approach from bright gardens is fitting, for from here is granted to those who desire in their departure to holy Paradise.”

This same door is adorned with further lines inside:

“Each of you that departs from the house of the Lord, after completing your prayers in due order, remove your bodies but remain here in heart.”

13. The outlook of the basilica is not, after the usual fashion, towards the east, but faces

the basilica of the blessed Lord Felix, looking out upon his tomb. But the apse winds round, extending with two sides on the right and left in the spacious area around. One of these is available to the bishop when making his sacrifices of joy, whilst the other takes the praying congregation in its large recess behind the priest. The whole of this basilica opens on to the basilica of our renowned confessor, giving great pleasure to the eye; there are three external arches, and the light floods through the lattice by which the buildings and courtyards of the two churches are connected. For because the new church was separated from the older one by the intervening wall of the apse belonging to some tomb, the wall was penetrated on the side of Saint Felix's church by as many doors as the new church has at its front entrance. So the wall is pierced to provide a view from one church into the other, as is indicated by the inscriptions posted between the doors on each side. So these lines are set at the very entrance to the new church:

“This beautiful house lies open for you to enter through the triple arch; this threefold door bears witness to devoted faith.”

14. Again, there are the following inscriptions on either side of that one, beneath crosses painted in red lead:

“The cross on high is circled by a flowery wreath, and is red with the blood which the Lord shed. The doves resting on this divine symbol show that God's kingdom lies open to the simple of heart.”

“With this cross slay us to the world and the world to us, bringing life to our souls by destroying our guilt. If your peace thrives in our hearts made pure, O Christ, you will make us also your pleasing doves.”

15. Within the lattice, which now bridges the short distance previously dividing the adjoining basilicas, over the central arch on the side of the new basilica are inscribed these lines:

“As Jesus our peace has destroyed the dividing barrier, and made us one with Him, sweeping away our divorce by means of the cross, so we see this new building no longer sundered from the old, but joined to it and united by the doors. A fountain gleaming with its attendant water plays between the holy churches, and washes the hands of these who enter with its ministering stream. The people worship Christ in both these churches of Felix, governed by Paul their bishop with apostolic words.”

The following couplets are inscribed over the other arches which stand on each side. On the one:



“On eyes bemused a new light dawns. He who stands on the single threshold sees twin churches simultaneously.”

On the other:

“Twin churches now lie open by means of three sets of thin arches. Each admires the decoration of the other over threshold which they share.”

On these arches at the front, facing the basilica of the Lord Felix, these verses are set over the centre:

“You whose devoted faith constrains you in great crowds to hymn blessed Felix with diverse tongues, stream through the threefold entrance in loose-knit throng. For though you come in thousands, the huge churches will have space for you. Paul the bishop consecrates them for immortal purposes, as they stand close joined to each other by means of the open arches.”

On the other arches are these two couplets:

“You who have left the old church of holy Felix, now pass to his new abode.”

“That single faith which worships One under three names receives with its triple entrance those of single mind.”

16. The following lines are inscribed in the two sacristies which, as I mentioned, enclose the apse on each side. They describe the purposes of each of them. To the right of the apse we read:

“This is the place where the sacred food is stored; from here is brought forth the nourishing repast of the holy service.”

And on the left of the apse:

“If a person decides piously to meditate upon the Law, he will be able to sit here and concentrate upon the holy books.”

17. Let us now leave this basilica at Nola and pass to that at Fundi, a town equally dear to me whilst I had property there, which was then a more frequently visited by me. So I had longed to found a basilica there as a pledge of my affection as a resident or to commemorate my former estate there; for the town was in need of a new one, since the existing church was tumbledown and small. So I thought I should append here these modest verses which I have composed for the dedication of that basilica at Fundi; for building is still in progress, but it is almost ready to be consecrated if God be kind.

The reason chiefly impelling me to send these verses is that my Victor liked the painting which is to be visible in the apse of the church, and he desired to convey the poems to you in case you wished to depict one or other of them in your newer basilica, which Victor says also incorporates an apse. (You must decide whether I should say *absida* here *abside*; I confess my ignorance, for I don't remember ever reading this latter form of the word.)

This little basilica of Fundi also will be consecrated by sacred ashes from the blessed remains of apostles and martyrs, in the name of Christ the Saint of saints, the Martyr of martyrs, the Lord of lords. For He Himself has guaranteed that He will in turn acknowledge those who acknowledge Him; so there is a second inscription describing this grace of His, quite separate from the reception of the painting. This is the description of the painting:

“Here the saints' toil and reward are rightly merged, the steep cross and the crown which is the cross's high prize. God Himself, who was the first to bear the cross and win the crown, Christ, stands as a snowy lamb beneath the bloody cross in the heavenly grove of flower-dotted Paradise. This Lamb, offered as an innocent victim in unmerited death, which rapt expression is haloed by the bird of peace which symbolises the Holy Spirit, and crowned by the Father from a ruddy cloud. The Lamb stands as judge on a lofty rock, and surrounding this throne are two groups of animals, the goats at odds with the lambs. The Shepherd is diverting the goats to the left and is welcoming the deserving lambs on His right hand.”

These are the verses on the relics:

“Under the lighted altar, a royal slab of purple marble covers the bones of holy men. Here God's grace sets before you the power of the apostles by the great pledges contained in this meagre dust. Here lie father Andrew, the gloriously famed Luke, and Nazarius, a martyr glorious for the blood he shed; here are Protasius and his peer Gervasius, whom God made known after long ages to His servant Ambrose. One simple casket embraces here his holy band, and in its tiny bosom embraces names so great.”

18. These and other works of the same kind, distinguishable on earth from things of earth, are the temporary buildings at which I have toiled, dear brother. But blessed be the Lord day by day, who alone doth wonderful things. As He turned the rock into pools of water, so He transforms earthly things into heavenly, deigning to make this change in company with us though all things on earth and in heaven are His. So all our physical labours on earth are through Him being built up secretly in heaven, and will be revealed to us when we see with the naked eye what we now anticipate through faith. We sow on earth, therefore, and reap in heaven. Here we strew and there we gather. Here we dwell but our conversation is there. We gird ourselves here and are soldiers there. We fight here

and conquer there; or if we conquer here we are crowned there. So that we build by our hands here we store up for ourselves there by faith.

And if we build our structures, however earthly, with spiritual prayer and study, this becomes a blessed preparation for the heavenly mansions. For even as we erect these buildings in the Lord because we have received the faith, we are ourselves erected by the Lord through the growth of this same faith. The centurion of the Gospel exemplifies for us the certain expectation that we may win eternal reward especially because of such building. He was able to merit the healing of his son, and the praise of his faith by the Lord Jesus Himself, precisely because the Lord's people (at that time comprising only the Jews) commended him by witnessing to his building of a synagogue.

19. Why, then, do we poor souls remain idle and yawning? Why do we stand inactive in the noisy forum of this world as though we were not hired labourers? Or, if we reflect that we owe the master of the house his denarius and so perform some work in his vineyard, why do we flaunt that work not as a debt but as a favour, and even contemplate adding it to the Lord's credit account, as though we were doing something of benefit to Him rather than ourselves? Wretched creatures that we are, we think that we bestow gifts; in performing our business we gain a reputation for generosity, but we are convicted of the utmost greed. Indeed, we are greedier than the keenest usurers of this world, for it is a more handsome transaction to purchase heavenly possessions for earthly, and to purchase blessedness for misery and need, than it is to swap earthly objects for other earthly ones, to trade for things now decaying others which will decay; it is better to lend money to the Lord than to man. He who puts out money to usury and takes bribes against the innocent is condemned in the Law. But see how the grace of the Gospel shows us how these crimes are transformed into innocence and holiness, and that repayment not of punishment but of reward follows, if only those sins are converted towards God's precepts for salvation by the keenness of faith. Put out your money for usury, but for Christ; the usury brings salvation.

20. Again, in the world judges who are bribed by gifts from defendants are condemned. But if one is detected in some sin, and if having no confidence in your innocence you offer the price of your salvation to our Judge, you need not fear to commit the injustice of bribery against God's justice. Christ gladly accepts from you the reward of your salvation, because He prefers mercy and not sacrifice.

But perhaps you ask where you are to find Him, and how you are to bribe Him when you cannot see Him. Scripture says: Rise, thou that sleepest, and arise from the dead, and thou shalt come upon Christ. In other words, shake off the sleep of physical idleness. Lift your

mind, now downcast with earthly thoughts, from the cares of the dead, which are the life of the flesh. Raise and direct your soul to the Lord and thou shalt come upon Christ. By acting according to His precepts, you will see Him in every poor man, touch Him in every needy person, entertain Him in every guest, since He Himself bears witness that what is done to His least brethren in His name is done to Him. So now you know how you are to see Him though He is invisible, and to lay hold of Him though He cannot be grasped.

So now let us be paupers here, that we may be enriched later in Heaven. Let us weep now, so that we may later rejoice. Let us weep now, so that we may later rejoice. Let us be hungry now, to gain our fill then. The poor you have always with you, says Christ. You observe that you have no excuse for ever delaying a kindness, for the poor man is at hand if only our will is not lacking.

21. So let us now throw off anxiety and make gifts to Christ who is in need even in the persons of His poor, so that we can share in His glory which will abound in them. This is why the Lord Himself gives us warning with the words: Make unto your friends of the mammon of iniquity. You see how the Almighty makes light from darkness and justice from wickedness, so that when you shall fail they may receive you into everlasting dwellings.

For the human race is governed by a kind of alternation of riches and poverty. This the Gospel story makes clear in the case of the rich man in hell and the poor man in the kingdom of heaven, so that we may understand the design of Him who created both. By this design He created the rich for the poor and the poor for the rich, so that he who has plenty may provide sustenance for the needy, and the poor man may be the means for just action to the wealthy. So, as Paul puts it, there may be an equality, and the eternal wealth which must in the next life compensate the poor for their indigence here may flow back to meet our need, if only our wealth in this world has given aid to their poverty.

Let us, then, sow seeds of the flesh in them, that we may reap spiritual harvests from them, Let our hands now occupy themselves with earthly gifts, that our souls may be refreshed with heavenly lines. Let present hope build possessions for the future. Let us construct dwellings here to cover our heads in the next world, where he is needy and I am rich, that he may feed me in the next, where he will be filled and I shall want. Not this spiritual transaction and deny, if you can, that we are greedy who sell our land and tithes to purchase exemption from payment and obtain eternal life in the kingdom.

22. We put down crumbling sand to build on it an eternal house, to reach the stars by means of cheap quarried stone. By this stone we do not vainly build that tower of confusion and pride which is doomed to destruction. Rather we base ourselves on the

Cornerstone Himself, so that through Him who is a tower of strength in the face of the enemy we may rise to His fullness. He Himself bids us build this tower only after prior reckoning of the cost, in case we fail and stop building and have to endure the stigma of rash thoughtlessness, and the deserved mockery for our cowardice with its vain show of daring. The cost we must pay is unflinching faith.

So he who believes according to God's truth, who makes the Lord Jesus his Hope and Wealth and Strength, builds a structure which all coheres and grows and rises and mounts to the fullness of God. Unless the Lord build the house, therefore, we shall sweat and labour in vain that build it. And even when the building is completed (and this is achieved only with the Lord's aid), there is a danger that we may sit back and complacently abandon our efforts; so divine Scripture adds that unless God also guards the house when it is built, the watchful care of those who preserve it will be in vain.

23. So let us entreat the Lord that, while we build a visible lodging for Him outside ourselves, He may build within us a lodging which is invisible – in Paul's words, that house not made with hands, the entry to which will at the end give us understanding, when we see face to face what we now see in a dark manner and know in part.

But now, whilst we are still established in the tabernacle of our earthly bodies, we dwell, so to say, amongst the tents in the desert, under the canvas of that ancient tabernacle; and the word of God goes before us through the parched region of this world, in a pillar of a cloud, to overshadow our heads in the day of battle, or in a pillar of fire, that we may know his heavenly way on earth. Let us pray that through these present tabernacles of the Church we may go into the house of God, where dwells our highest Lord Himself, the Cornerstone made for us by the Lord, the stone hewn from the mountain and grown into a mountain, which is wonderful in our eyes.

May He offer Himself to our building both as its foundation and its top, for He is the beginning and the end. I pray that on this rock (for Christ, too, is the Rock, without which no man can build a steady house) our hands may not heap stubble or hay or straw, like the hands that served in baskets in Egypt, lest we waste our efforts, to use the proverbial phrase, on worthless building of foul construction and, bent beneath the burdens of servile toil, we turn our backs on the Lord. For on the one hand He refreshes with light those who turn to Him, but on the other He blinds those who turn away.

24. But as we build we must consider what we can erect from our frail and earthly material to be worthy of the divine foundation, so that being given life by the Cornerstone Himself we may be smoothed out to become stones for the construction of the heavenly temple. Let us fuse together the gold of our thoughts and the silver of our speech in Christ,

so that once we are cleansed in the furnace of this world, He who approves the souls that please Him may transform us into gold tried by the fire, worthy of the stamp of His image, and we by reason of our enlightened works may offer ourselves as precious stones to Him. Let us not be foolishly hard as teak in heart, or withered in works with the dryness of hay, or fickle and weak in faith or charity with the frailty of unsubstantial straw.

But to ensure that the work which we willed is not laid out for burning, but rises unshaken and with toil untroubled, let us beg from the Most High that peace for our building in which the famed wall was of old built into the temple, so that neither hammer nor axe nor any iron implement is heard upon it, nor, as afterward happened during the rebuilding of the temple through the hostile hatred of the Persians, may an enemy attack hinder and postpone the fresh construction of the building. For we shall become a house of prayer and peace only if no distracting anxieties of the flesh enfeeble us, only if no din of this world disturbs our tranquility.

Our hammer is the thought we take for food and clothing; our axe and iron implement are our longing for things of earth, our fear of death by night, our spiteful malice, and the possessions of this world, through the gnawing anxiety or contented love of which the soul is devoured and the mind enchained. The tranquility of a well-ordered will, which is strengthened when our thoughts are disciplined in the silence of religious life, and the concentration of prayer, which proceeds unhindered from a free and chaste heart, are uprooted by the din of bodily cares which are like the distracting noise of the hammer or the blow of the axe. But because He that is in us is greater than he that is in the world, the Lord can crush Satan under our feet, so that on our behalf that prophecy may be fulfilled: The hammer of the whole earth is destroyed.

25. But it is profitable for us that the Lord Jesus should often resist with the whip of His fear that temple of our hearts also which we have built, so that He may cast out from us the tables of the money-lenders and the sellers of oxen and doves, so that our minds may not concentrate on the dealings of greed, and so that the slow manner of oxen may not become installed in our thoughts; for where there are no oxen, the cribs are clean. Nor let us sell our innocence, the fruit of God's grace, lest we make our house of prayer a den of thieves.

Once our senses have been cleansed of all that gives rise to wickedness, our Lord Jesus Christ will gladly walk in them; in them, as in the five porticoes, will stroll Wisdom, God's strength, who healeth all our diseases. For in our souls, too, as in the porch by that healing pond of old, lie many sick and lame. If our souls hear the word of God, it will drive out the leprosy of greed, the cancer of envy, the blindness of dissipation, the madness of anger,

and the paralysis of luxury, through the healing of his command; and when we are restored not only to the health of innocence but also to the strength of patience, it will bid us there and then not only to rise from our bed of weakness but also to take it up, so that we may bear in strength what supported us in weakness.

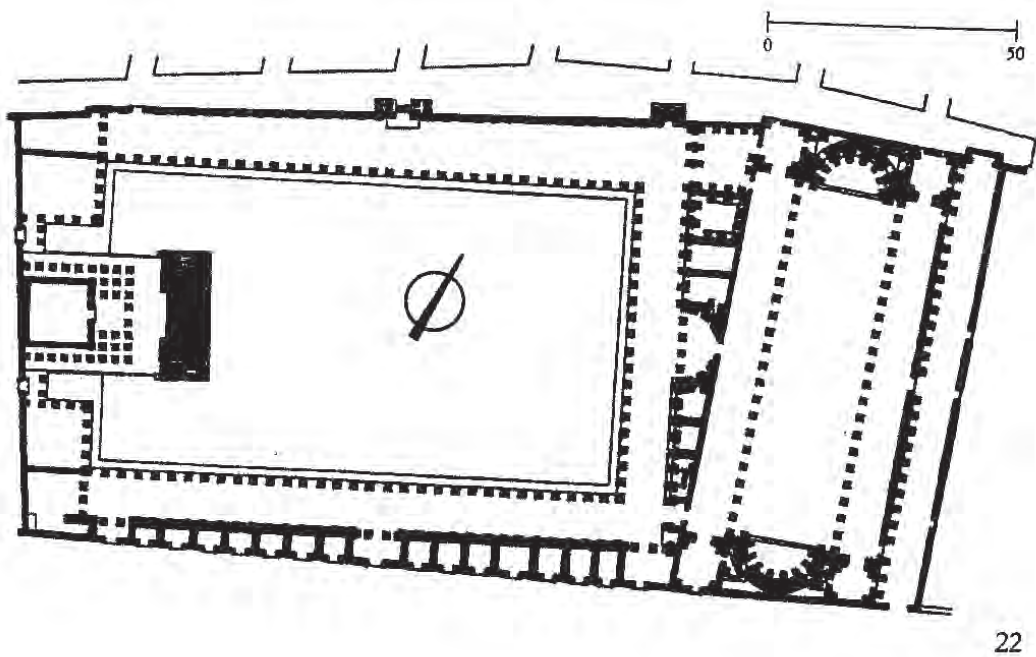
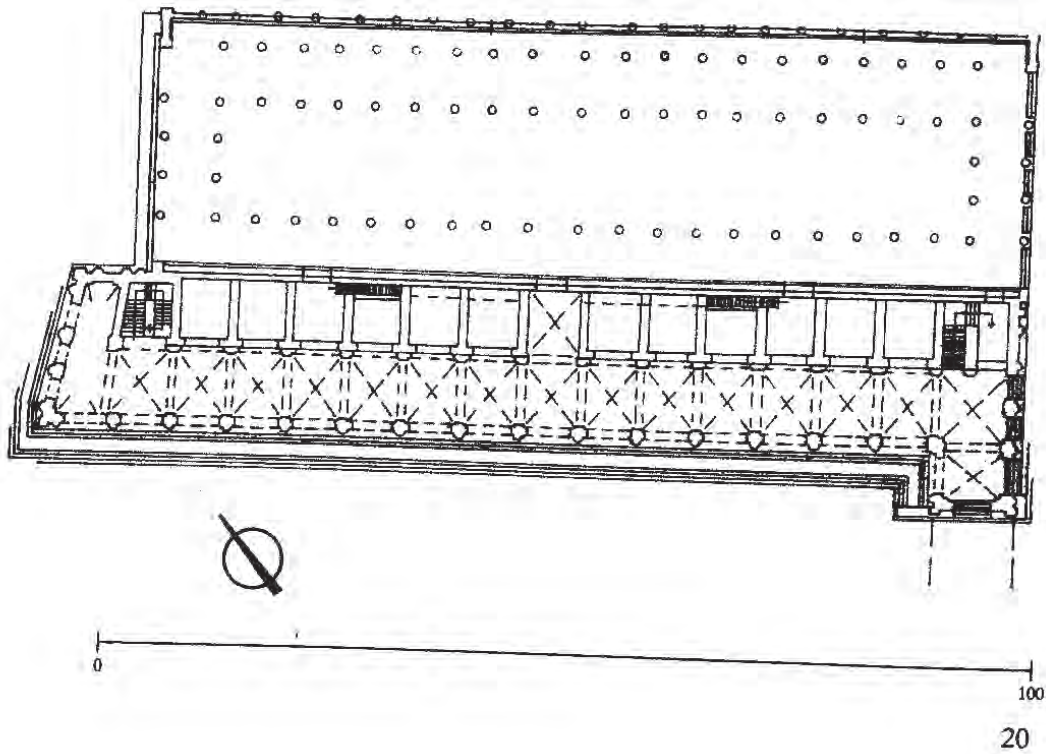
This miracle is surely fulfilled also in the spiritual sphere of our weakness or health. Our flesh was the bed to which we entrusted ourselves as we lay enchained in vices and feeble in virtues. But then our inner self is reformed to goodness and purity of mind by the word of God and through the grace of Jesus Christ. So we become healthy, and take up that flesh like the bed in Bible; we support in under the dominance of the spirit, and it attends us where we wish to go. In our sickness we awaited the help of another, and were always forestalled by the speed of those who entered the pool first, because there was no one to give us a hand or to make us whole. But then He who is greater than His envoys and angels (for He is the Lord of both prophets and angels) came, and in pity took in hand all our weakness. He took it up and healed it, and filled our hungry souls with good things, and bade us go into that house, which, as I have said, is not made with hands, in which there will be the voice of rejoicing and salvation. There, too, will be Christ as Dwelling and Kingdom and King for all His people, as Paul attests, for we shall be always with the Lord, to whom be honour, glory, and power forever.



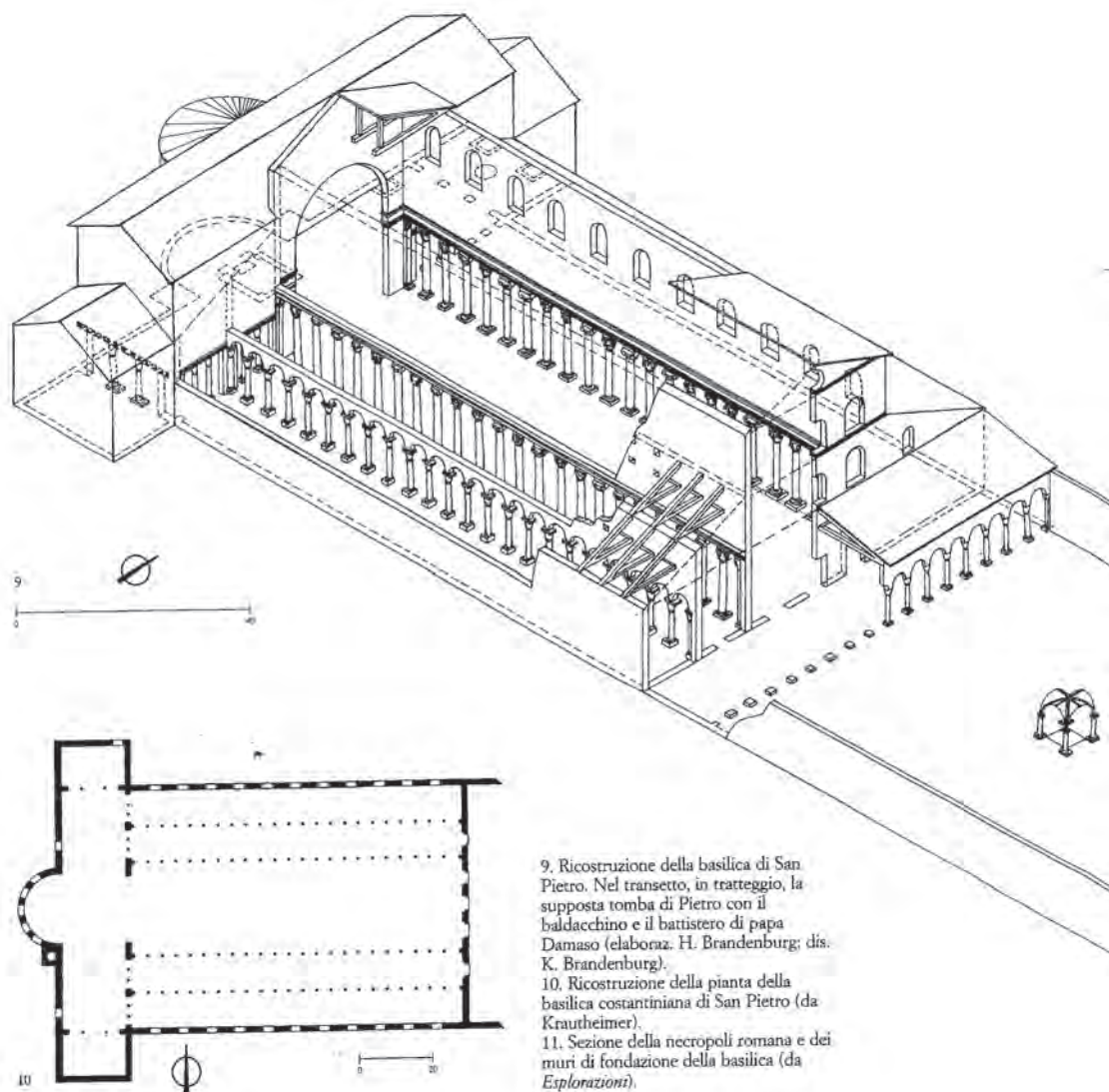


## 5. Appendix II

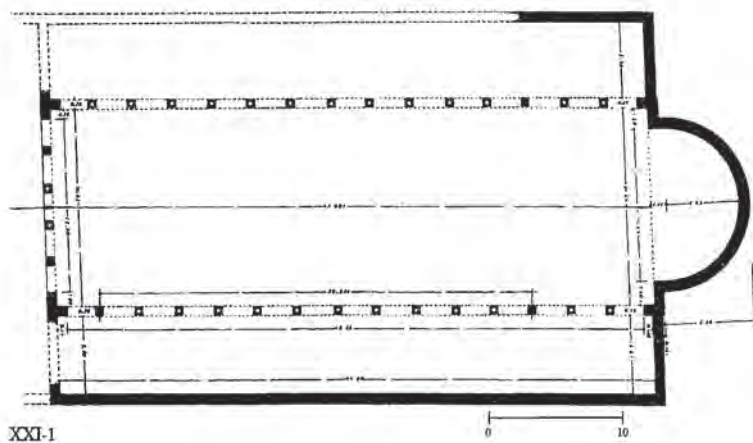
The basilicas relating to Table I (from Brandenburg 2004).



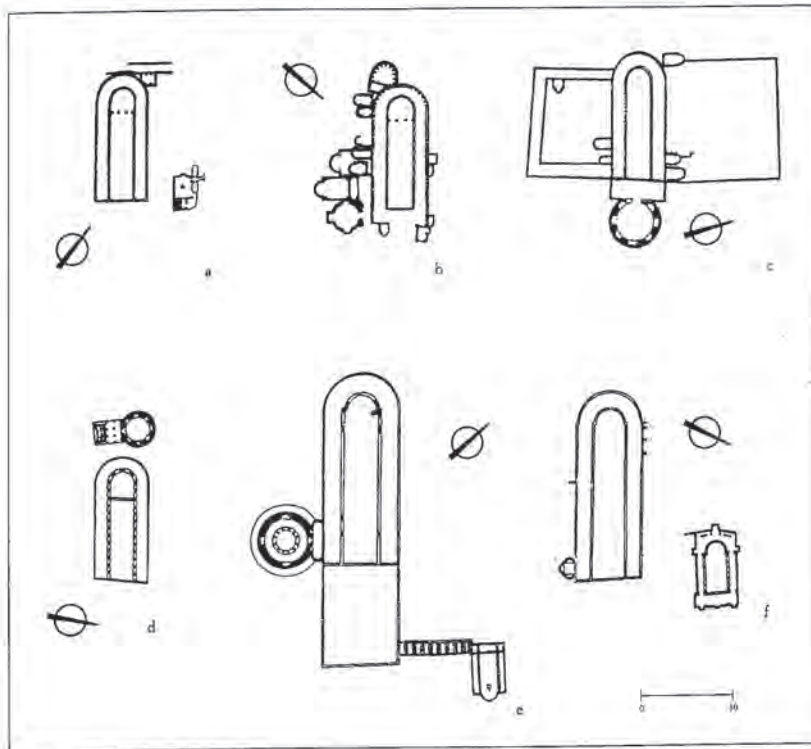
Basilica Iulia ad the basilica in Lepcis Magna



St. Peter's.

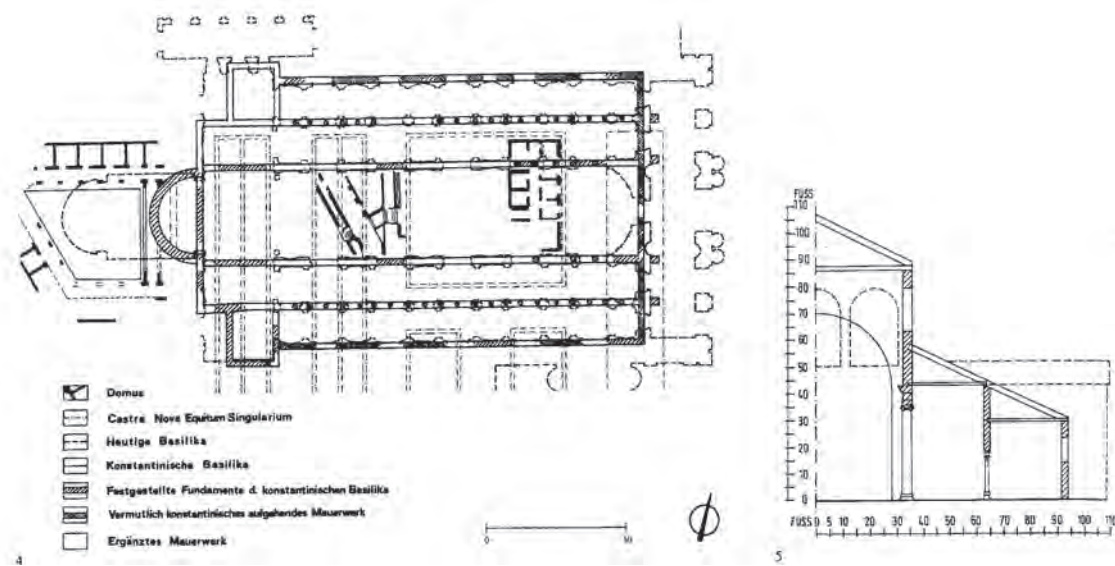


San Vitale.

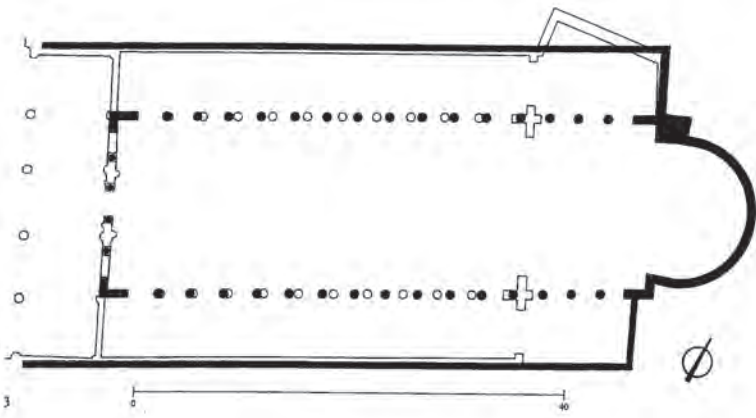
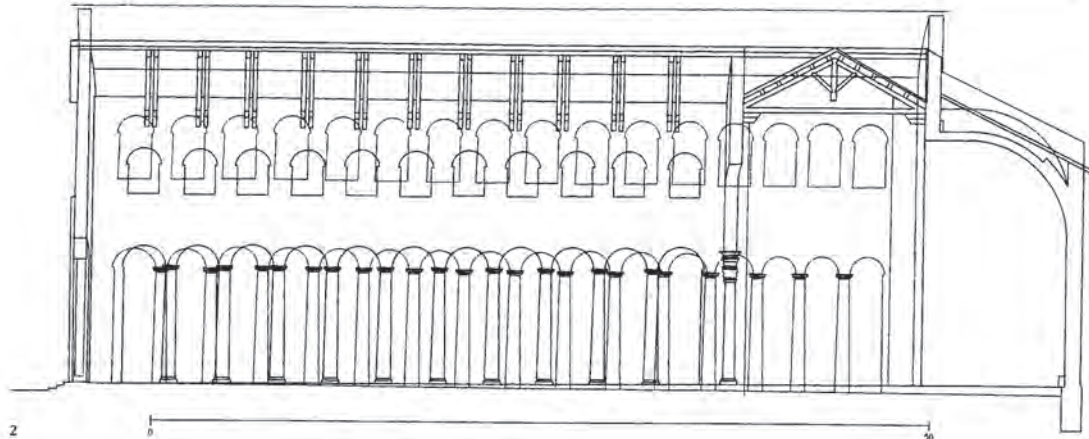
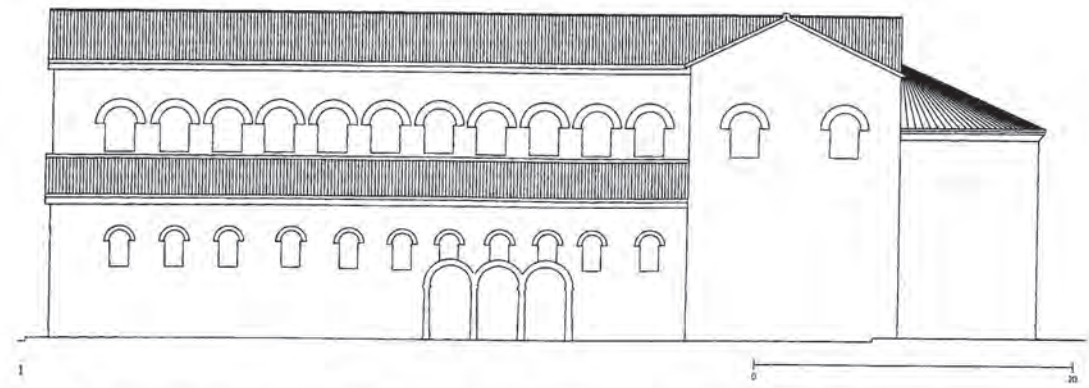


X-1. Comparazione delle piante disegnate alla stessa scala: a. Basilica della Via Ardeatina; b. S. Sebastiano; c. SS. Marcellino e Pietro; d. Basilica di Tor de' Schiavi; e. S. Agnese; f. S. Lorenzo fuori le mura (da Fiocchi Nicolai).

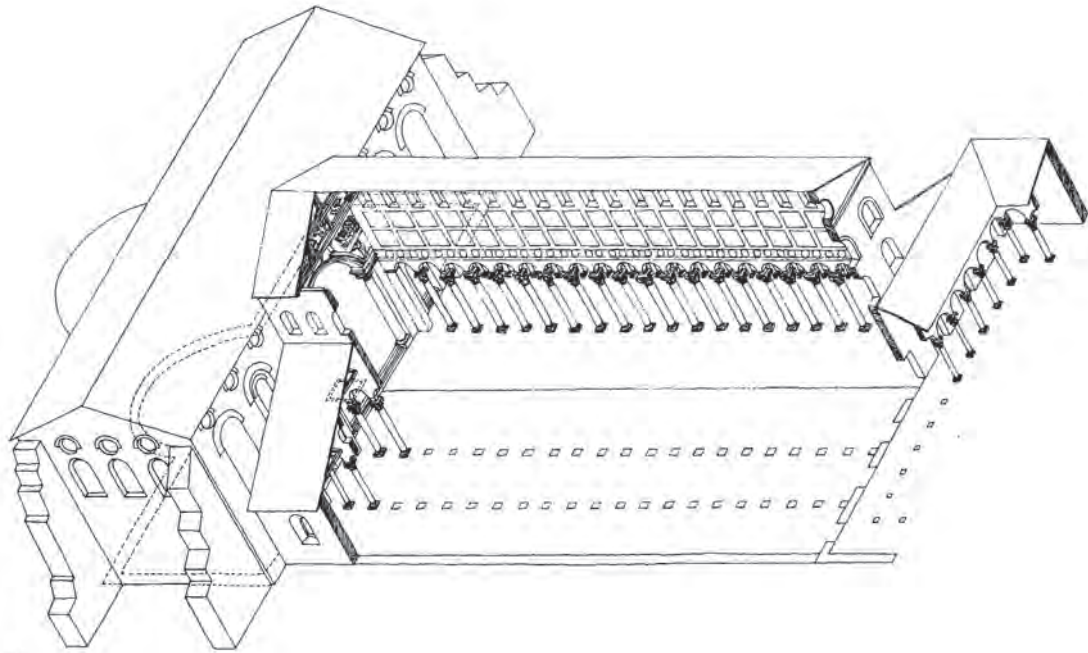
The *deambulatory*-basilicas in Rome.



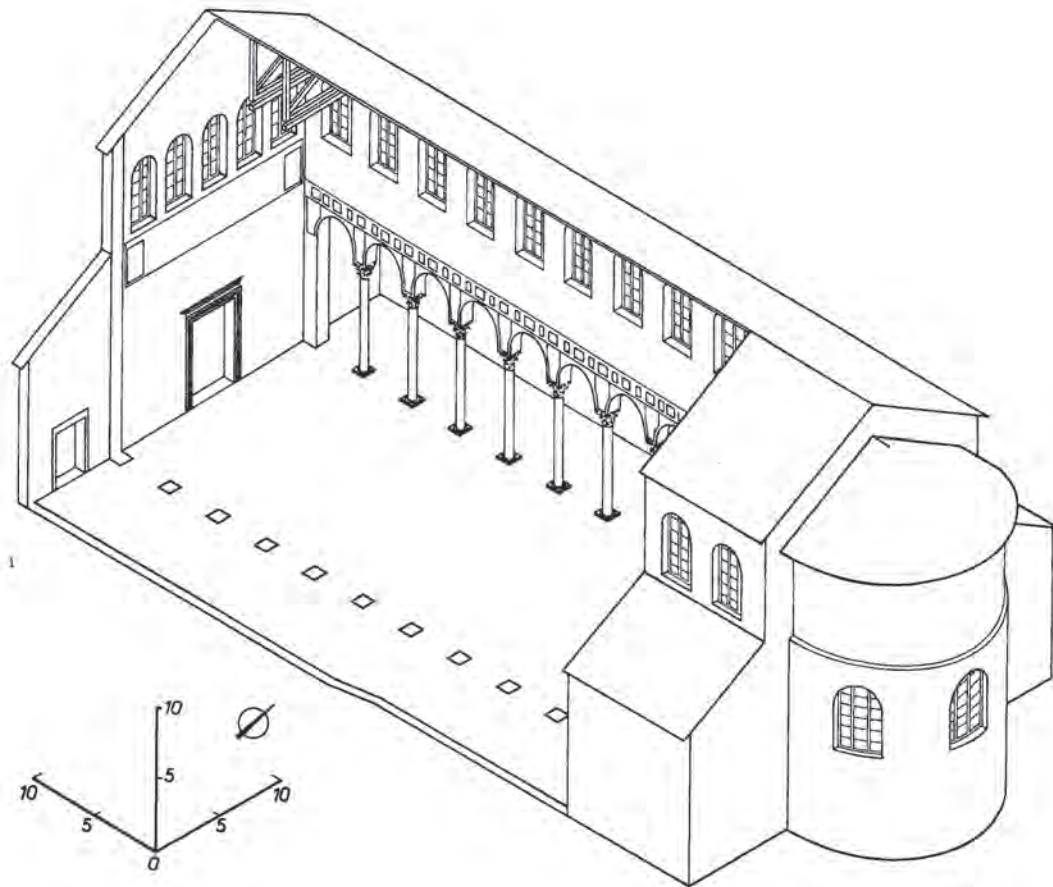
The Lateran Basilica.



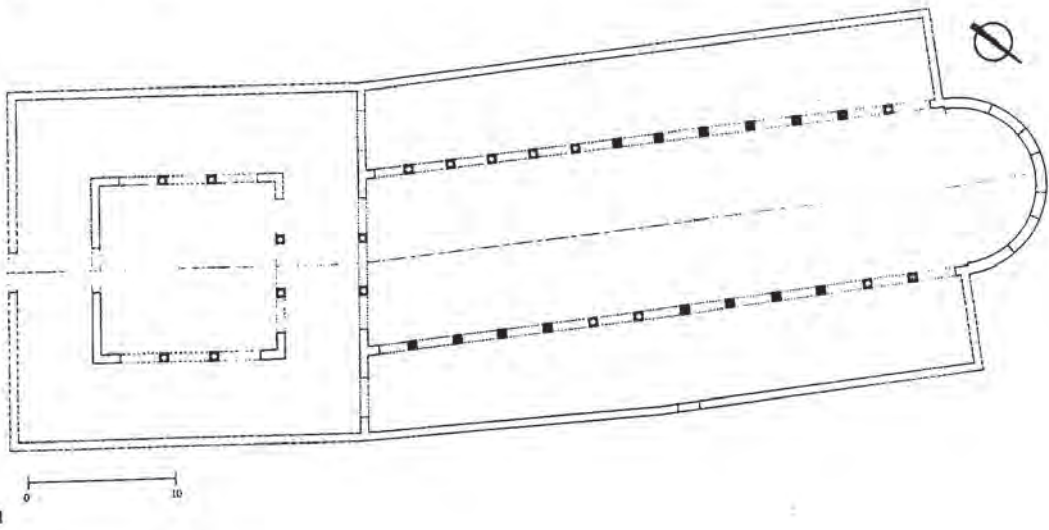
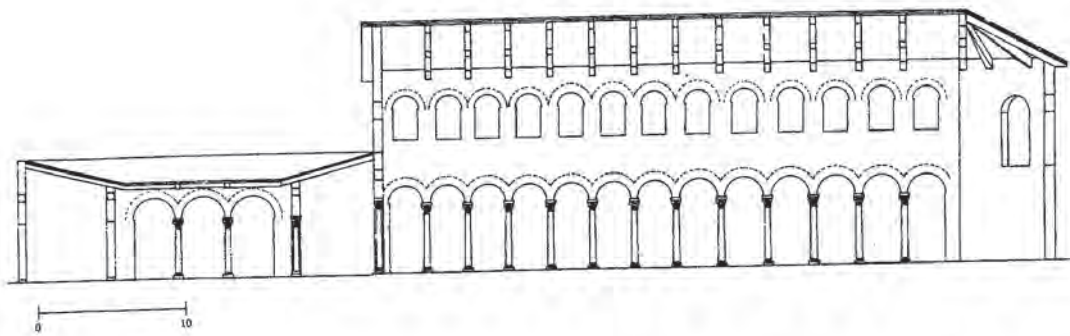
San Pietro in Vincoli.



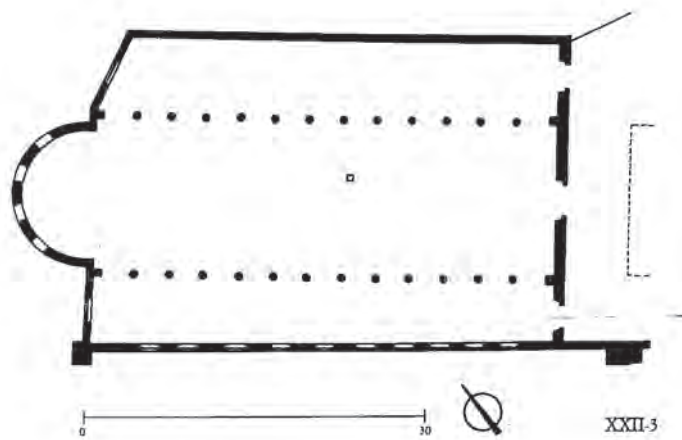
<sup>10</sup>  
San Paolo fuori le mura.



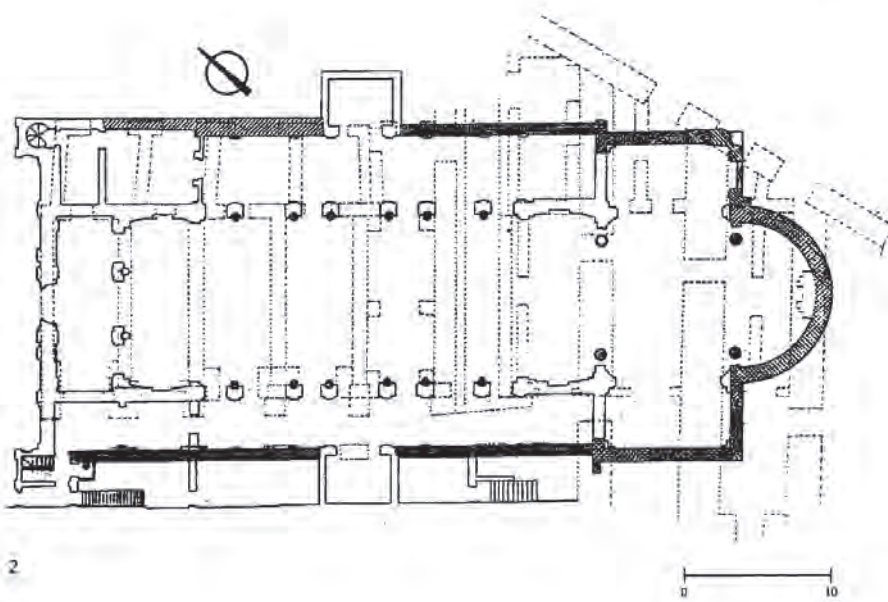
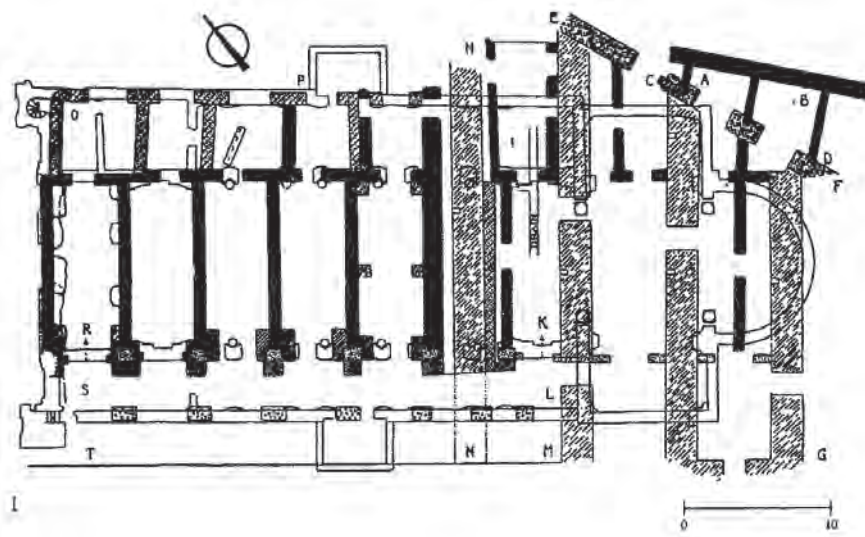
Santa Sabina.



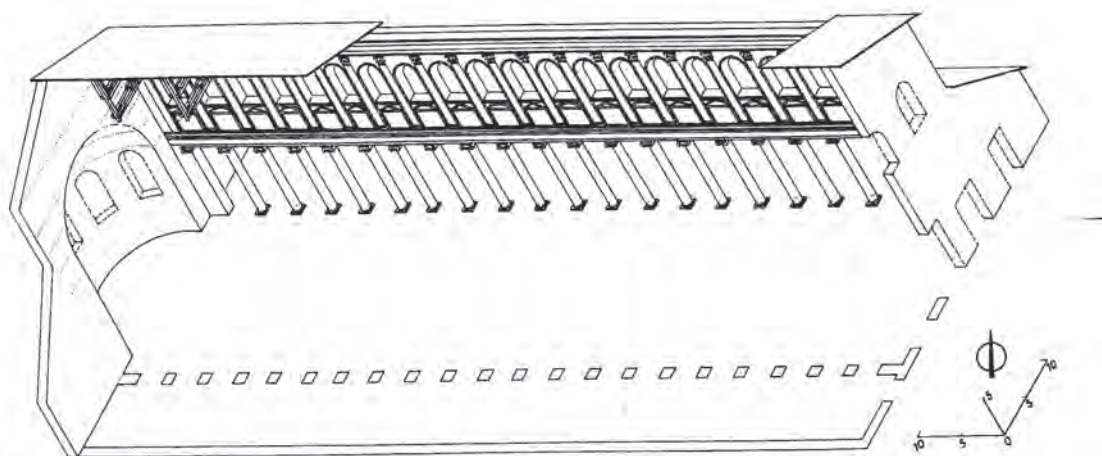
Santo Sisto Vecchio.



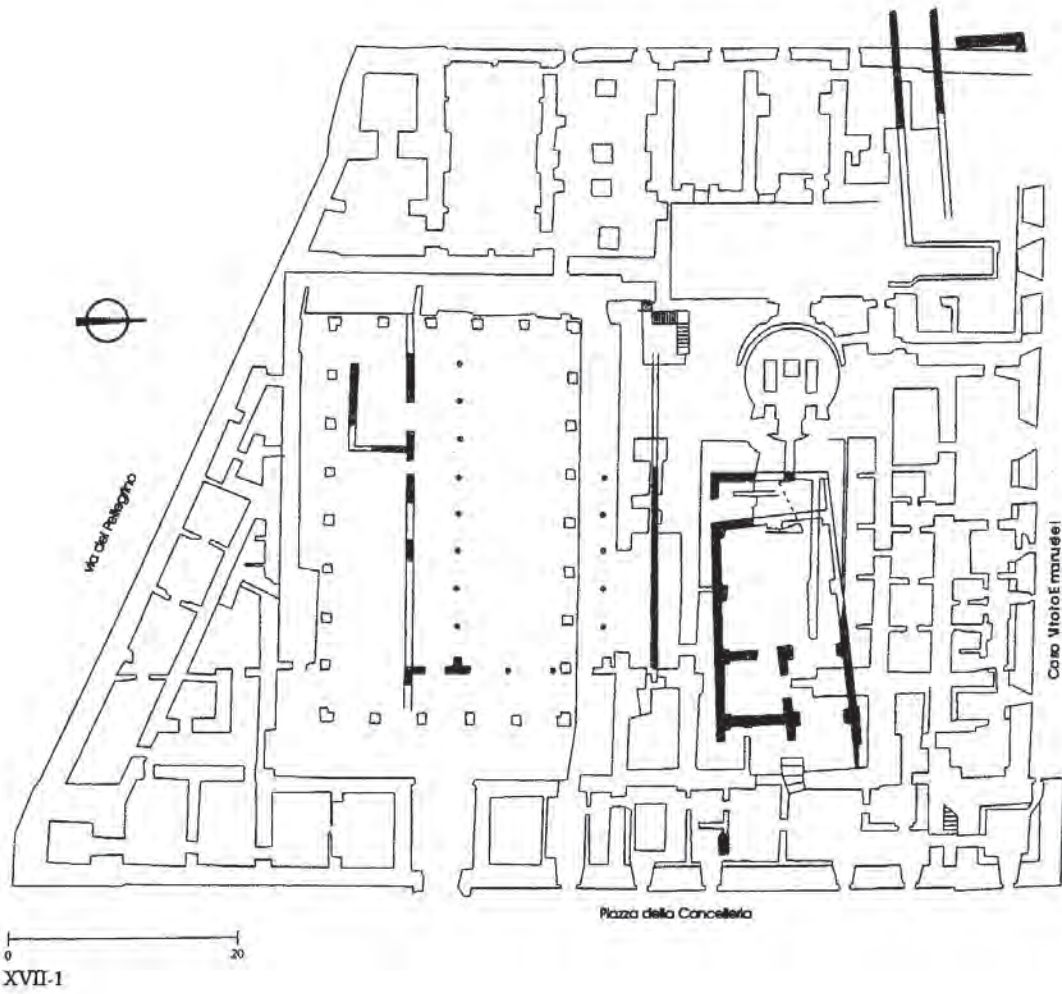
Santi Giovanni e Paolo.



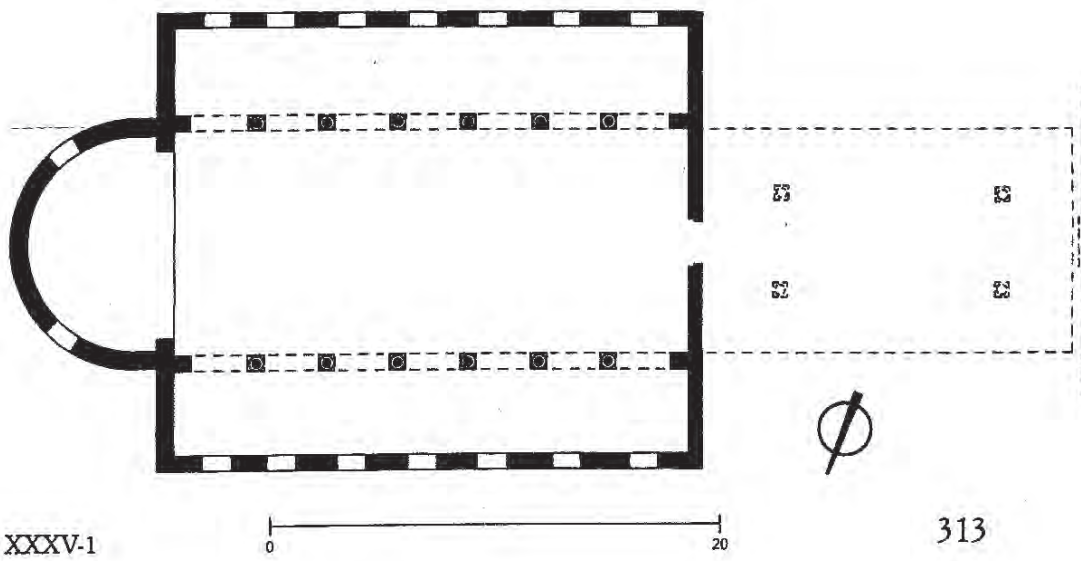
Sant'Anastasia.



1  
Santa Maria Maggiore.



San Lorenzo in Lucina.



Sant'Agata dei Goti.



## 6. Bibliography

### Abbreviations

ACISCR = Atti del congresso internazionale di studi sulle chiese di Roma

APARA = Atti della pontificia accademia romana di archeologia

CBCR = Corpus basilicarum christianarum Romae

CIL = Corpus inscriptorum latinarum

GC = Die Geschichte des Christentums - Religion, Politik, Kultur

ICUR = Inscriptiones Christianae Urbis Romae septimo saeculo antiquiores colligere coepit Iohannes Baptista De Rossi. Nova Series, 1922-1985.

ILCV = Inscriptiones Latinae Christianae Veteres

JAC = Jahrbuch für Antike und Christentum

JRA = Journal of Roman Archaeology

LP = Liber Pontificalis

LTUR = Lexicon Topographicum Urbis Romae

MAMA = Monumenta Asiae Minoris Antiqua

### Printed Sources

- St. Ambrose, *The letters of St. Ambrose, Bishop of Milan*, Edited by J. Parker 1881, Oxford.
- Dio Cassius. *Roman History, Volume VIII: Books 61-70*. Translated by Earnest Cary and Herbert B. Foster. 1925. Loeb Classical Library 176. Harvard University Press, Cambridge.
- Cassiodorus, *The Letters of Cassiodorus*, Edited by Thomas Hodgkin 1886, Oxford.
- Cicero, *Epistularum ad Atticum*, Loeb (Ed. 1939), London.
- Cyprian, Saint Bishop of Carthage. *S. Thasci Caecili Cypriani Opera omnia*. Edited by Wilhelm von Hartel. 1868-1871. Corpus scriptorum ecclesiasticorum Latinorum 3. C. Österreichische Akademie der Wissenschaften, Vienna.
- Aulus Gellius, *Noctium Atticarum*, (Ed. Loeb 1954), London.
- Gerontius. *The life of St. Melania, by His Eminence, Cardinal Rampolla*. Translated by E. Leahy. Edited by S. J. Herbert Thurston. 1908. Burns & Oates, London.
- *Epistolae Imperatorum Pontificum Aliorum Inde ab a. CCCLXVII usque DLIII datae Avellana Quae Dicitur Collectio*. Edited by O. Guenther. 1895. Corpus scriptorum ecclesiasticorum Latinorum 35, 2 parts. Österreichische Akademie der Wissenschaften, Prague, Vienna, Leipzig.
- Eusebius. *Ecclesiastical History, Volume I: Books 1-5*. Translated by Kirsopp Lake. 1926. Loeb Classical Library 153. Harvard University Press, Cambridge, MA.
- Eusebius. *Ecclesiastical History, Volume II: Books 6-10*. Translated by J. E. L. Oulton. 1932. Loeb Classical Library 265. Harvard University Press, Cambridge, MA.
- Gregory the Great. *The Dialogues of Saint Gregory the Great*. Translated by Edmund G. Gardner. 1911. P.L. Warner, London and Boston.
- Gregory of Nyssa. *Gregorii Nysseni Epistula Canonica. Opera dogmatica minora, Part*

5. Edited by Ekkehardus Mühlenberg. Brill, Boston and Leiden.
- Hieronymus, *Epistoles*, Translated by F. A. Wright, Loeb 1933
  - Hieronymus, *De viris illustribus*, Translated by E. C. Richardson, Christian Literature Publishing Co., 1892.
  - Livy. *History of Rome, Volume XIII: Books 43-45. Translated by Alfred C. Schlesinger. 1951.* Loeb Classical Library 396. Harvard University Press, Cambridge, MA.
  - Macrobius. *Saturnalia, Volume I-III: Books 1-7. Edited and translated by Robert A. Kaster. 2011.* Loeb Classical Library 510-512. Harvard University Press, Cambridge, MA.
  - Origen, *De Oratione*, Translated by W. A. Curtis. - Paulinus Nolanus, *Letters of St. Paulinus of Nola, Vol. I & II.* Edited by P. G. Walsh. 1996. Newman Press, New York.
  - Pausanias. *Description of Greece, Volume II: Books 3-5 (Laconia, Messenia, Elis 1). Translated by W. H. S. Jones and H. A. Ormerod. 1926.* Loeb Classical Library 188. Harvard University Press, Cambridge, MA.
  - Pausanias. *Description of Greece, Volume IV: Books 8.22-10 (Arcadia, Boeotia, Phocis and Ozolian Locri). Translated by W. H. S. Jones. 1935.* Loeb Classical Library 297. Harvard University Press, Cambridge, MA.
  - Pliny the Younger. *Letters, Volume I: Books 1-7. Translated by Betty Radice. 1969.* Loeb Classical Library 55. Harvard University Press, Cambridge, MA.
  - Prudentius. *Against Symmachus 2. Crowns of Martyrdom. Scenes From History. Epilogue. Translated by H. J. Thomson. 1953.* Loeb Classical Library 398. Harvard University Press, Cambridge, MA.
  - Quintilian. *The Orator's Education, Volume V: Books 11-12. Edited and translated by Donald A. Russell. 2002.* Loeb Classical Library 494. Harvard University Press, Cambridge, MA.
  - Sidonius. *Poems. Letters: Books 1-2. Translated by W. B. Anderson. 1936.* Loeb Classical Library 296. Harvard University Press, Cambridge, MA.
  - Sidonius. *Letters: Books 3-9. Translated by W. B. Anderson. 1965.* Loeb Classical Library 420. Harvard University Press, Cambridge, MA.
  - Suetonius. *Lives of the Caesars, Volume I: Julius. Augustus. Tiberius. Gaius. Caligula. Translated by J. C. Rolfe. Introduction by K. R. Bradley. 1914.* Loeb Classical Library 31. Harvard University Press, Cambridge, MA.
  - Suetonius. *Lives of the Caesars, Volume II: Claudius. Nero. Galba, Otho, and Vitellius. Vespasian. Titus, Domitian. Lives of Illustrious Men: Grammarians and Rhetoricians. Poets (Terence. Virgil. Horace. Tibullus. Persius. Lucan). Lives of Pliny the Elder and Passienus Crispus. Translated by J. C. Rolfe. 1914.* Loeb Classical Library 38. Harvard University Press, Cambridge, MA.
  - Tacitus. *Histories: Books 4-5. Annals: Books 1-3. Translated by Clifford H. Moore and John Jackson. 1931.* Loeb Classical Library 249. Harvard University Press, Cambridge, MA.
  - Tacitus. *Annals: Books 13-16. Translated by John Jackson. 1937.* Loeb Classical Library 322. Harvard University Press, Cambridge, MA.

- Vitruvius. *On Architecture, Volume I: Books 1-5. Translated by Frank Granger.* 1931. Loeb Classical Library 251. Harvard University Press, Cambridge, MA.

## Literature

- W.Y. Adams and E.W. Adams. 1991. *Archaeological Typology and Practical Reality – A Dialectical Approach to Artifact Classification and Sorting.* Cambridge University Press, Cambridge.

- C. Alexander. 1977. *A Pattern Language: Towns, Buildings, Construction.* Oxford University Press, New York, NY.

- M. S. Arena et al. 2000. *Roma dall'antichità al medioevo, archeologia e storia.* Electa, Roma.

- M. Armellini and C. Cecchelli. 1942. *Le chiese di Roma dal secolo IV al XIX, nuova edizione a cura di C. Cecchelli.* XXX, Roma.

- J.C. Anderson. 1997. *Roman Architecture and Society.* Johns Hopkins University Press, Baltimore, MD.

- J. Barclay-Lloyd. 1989. *The medieval Church and Canonry of S. Clemente in Rome.* Apud San Clemente, Rome.

- J. Barclay-Lloyd. 1986. "The Building History of the Medieval Church of S. Clemente in Rome", *Journal of The Society of Architectural Historians* 45, 197-223.

- L. Barelli. 2009. *The monumental complex of Santi Quattro Coronati in Rome.* Viella s.r.l., Roma.

- L. Barelli, R. Pugliese and L. Sadori. 2008. "Nuovi dati dallo scavo del chiostro del complesso dei SS. Quattro Coronati a Roma", *APARA* 80, 77-122.

- C. la Bella. 2003. *San Saba.* Fratelli Palombini editori, Roma.

- S. De Blaauw. 2001. "L'altare nelle chiese di Roma come centro di culto e della committenza papale", in *Roma nell'alto medioevo, Settimane di studio del centro italiano di studi sull'alto medioevo XLVIII, Tomo secondo.* Presso la Sede del centro, Spoleto.

- S. De Blaauw. 2001. "Arredi di culto e disposizioni liturgiche a Roma da Costantino a Sisto IV", in *Atti del Colloquio Internazionale, Roma, 3-4-dicembre 1999.* Meddelingen van het Nederlands Instituut te Rome, Roma.

- J. A. Barceló et al. 2000a. "The diversity of archaeological virtual worlds" in *Virtual Reality in Archaeology*, ed. J. A. Barceló et al. Archaeopress, Oxford.

- J. A. Barceló et al. 2000b. "Visualizing what might be: an introduction to virtual reality techniques in archaeology" in *Virtual Reality in Archaeology*, ed. J. A. Barceló et al. Archaeopress, Oxford.

- D. Bénazeth. 2002. *Baouit: une église copte au Louvre.* Éditions de la Réunion des musées nationaux, Paris.

- K. Bowes. 2012 (1st edition 2010). *Houses and Society in the Later Roman Empire.* Bristol Classical Press, London.

- K. Bowes. 2008. *Private Worship, Public Values and Religious Change in Late Antiquity.* Cambridge University Press, New York, NY.

- L.E. Boyle, O.P. 1988. "The Site of the Tomb of St. Cyril in the Lower Basilica of S. Clemente Rome", in *Christianity among the Slavs. The Heritage of Saints Cyril*

and Methodius. *Acts of the International Congress Held on the Eleventh Centenary of the Death of St. Methodius. Rome, October 8-11*, ed. E.G. Farrugia et al. Pontificium Institutum Studiorum Orientalium, Rome.

- L.E. Boyle, O.P. 1978. "The Fate of the Remains of St. Cyril", *San Clemente. Miscellany 2. Art and Archaeology*, 12-35.

- L.E. Boyle, O.P. 1977. *The Community of SS. Sisto e Clemente in Rome 1677-1977*. Collegio San Clemente, Roma.

- L.E. Boyle, O.P. 1976. *Piccola guida di S. Clemente*. Collegio San Clemente, Roma.

- M. Braconi. 2012. "Una nuova lastra gradese con una singolare scena liturgica. Per una iconografia paleocristiana della consignatio", *APARA* 84, 121-154.

- Hugo Brandenburg, *Die Frühchristliche Kunst in Italien und Rom (Spätantike und frühes Christentum)*, Propyläen Kunstgeschichte Suppl. I, Berlin-Wien 1977.

- Hugo Brandenburg, *Roms Frühchristliche Basiliken des 4. Jahrhunderts*, Heyne Stilkunde 14 1979, München.

- H. Brandenburg. 2007. "Der Frühchristliche Monumentalkomplex von Cimitile/Nola - Ein Gründungsdenkmal europäisches Religions-, Kultur- und Kunstgeschichte in seinem historischen Umfeld", in *Der basilikale Komplex in Cimitile: Ein Weltkulturerbe?*, ed. M. de Matteis and A. Trinchese. Athena, Oberhausen.

- H. Brandenburg. 2004. *Le Prime Chiese di Roma - IV-VII secolo*. Jaca Book SpA, Milano.

- Hugo Brandenburg, *Letizia Ermini Pani*, Atti delle giornata tematica dei Seminari di Archeologica Cristiana, École Fran. De Roma - 9.3.2000, Città del Vaticano 2003.

- O. Brandt. 2014. *The Archaeology of Roman Ecclesial Architecture and Study of Early Christian Liturgy*. Peeters, Leuven.

- O. Brandt. 2012. *San Lorenzo in Lucina - The transformations of a Roman quarter*. Svenska Institutet Rom, Stockholm.

- W. Brownlow. 1897. "The Ancient Basilica of S. Clemente Rome", *Proceedings of the Clifton Antiquarian Club* 4, 139-153.

- P. Brown. 2012. *Through the Eye of a Needle - Wealth the Fall of Rome, and the Making of Christianity in the West 350-550 AD*. Princeton University Press, Princeton, NJ.

- G. Brunengo and F. Berardinelli. 1859-1862. "La basilica di S. Clemente in Roma. Scoperta di affreschi e di altri monumenti", in *Civiltà Cattolica, Serie IV (1859); Serie V (1862)*. Civiltà Cattolica, Roma.

- Ch. C.J. Bunsen. 1842. *Die Basiliken des christlichen Roms nach ihrem Zusammenhange mit Idee und Geschichte der Kirchenbaukunst*. J.G. Cotta'schen Buchhandlung, München.

- L. Cantarelli. 1915. *Il mitreosotto la basilica di S. Clemente*. Boll. Comunale, Roma.

- A. G. Curcio and F. De Cesaris. 2002. *Le Nuove Strutture realizzate per riportare in luce un'antica fonte battesimale in San Clemente e I conseguenti lavori di restauro*. Ecclesiae Urbis, Pontificio Istituto di Archeologia Cristiana, Roma.

- M. Caperna. 1999. *La basilica di Santa Prassede - Il significato della vicenda architettonica*. Edizioni d'Arte Marconi, Genova.

- A. Carandini, A. Ricci, M. De Vos. 1982. *Filosofiana la villa di piazza armerina*. Casa editrice: S.F. Flaccovio, Palermo.
- A. Carignani. 2000. “La domus dei Simmachi”, in *Aurea Roma dalla città pagana alla città cristiana*, ed. S. Ensoli and E. La Rocca. “L’erma” di Bretschneider, Roma.
- A. Carignani. 1993. “La topographia antica nella sommità del Celio: Gli Scavi nell’Ospedale Militare (1982-1992)”, *Mitteilungen des Deutschen Archaeologischen Instituts, Römische Abteilung* 100, 443-505.
- G. B. Casti and G. Zandri. 1999. *San Pietro in Vincoli*. Fratelli Palombini editori, Roma.
- C. Cecchelli. 1951. *S. Clemente*. Roma Nobilis, Roma.
- M. Cecchelli, *Note sui “Titoli” romani*, *Archeologia Classica* 38 1985, Roma.
- M. Cecchelli. 1974. “Osservazioni sulla basilica inferiore di S. Clemente in Roma”, *Rivista di archeologica cristiana* 50, 93-120.
- C. Cecchelli. 1930. *S. Clemente. Le Chiese di Roma illustrate*. Roma s.d., Roma.
- H. Chadwick. 1993. *The Early Church*. Penguin Books, London.
- D.L. Clarke. 2014. *Models in Archaeology*. Taylor and Francis, Hoboken, NJ.
- F. Coarelli. 2007. *Rome and Environs - An Archaeological Guide*. University of California Press, London.
- A.M. Colini (ed.). 1962. *Ludus Magnus*. Monte dei paschi di Siena, Roma.
- A.M. Colini, *Storia e topografia del Celio nell’antichità*, *Mem. Pont. Accad. Rom. di Archeologia* S. II 1944, Roma.
- K. Cooper. 2007. “Poverty, obligation and inheritance: Roman heiress and varieties of senatorial Christianity in fifth-century Rome” in *Early Christian Rome, 300-900*, ed. K. Cooper and J. Hillner. Cambridge University Press 2007, Cambridge.
- B.V. Cosentino. 1989. “L’atrio basilica di S. Clemente”, *Studi Romani* 37, 309-323.
- L. Crippa. 2003. *La basilica cristiana nei testi dei padri dal II al IV secolo*. Libreria Editrice Vaticana – Cad & Wellness, Milano.
- J.R. Curran. 2002. *Pagan City and Christian Capital: Rome in the Fourth Century*. Clarendon Press, Oxford.
- M.F. Cumont. 1915. “Découvertes nouvelles au Mithréum de Saint-Clément à Rome”, *Comptes rendus des séances de l’Académie des Inscriptions et Belles-Lettres* 59, 203-211.
- A. Claridge. 1998. *Rome. Oxford Archaeological Guides*. Oxford University Press, Oxford.
- R. Davis. 2000. *The Book of Pontiffs - The ancient biographies of the first ninety Roman bishops to AD 715*. Liverpool University Press, Liverpool.
- S. Demougin. 1997. “Procurator monetæ”, *Revue numismatique* 6, 41-45.
- H. Denard. 2012. “A New Introduction to the London Charter, Chapter 6” in *Paradata and Transparency in Virtual Heritage*, ed. A. Bentkowska-Kafel, D. Baker and H. Denard. Ashgate, Farnham.
- S. Diefenbach. 2007. *Römische Erinnerungsräume*. Walter de Gruyter, Berlin.
- A. Doig. 2010. *Liturgy and Architecture: From the Early Church to the Middle Ages*. Ashgate, Farnham.
- R.M. Dowdall, O.P. 1950. *A Short Guide to the Historical Monuments in Saint Clement’s*

Rome. S. Sabiane, Roma.

- J.-N-L. Durand. 1800. *Recueil et parallèle des édifices de tout genre, anciens et modernes: remarquables par leur beauté, par leur grandeur; ou par leur singularité, et dessinés sur une même échelle*. Gille, Paris.
- J.-N-L. Durand. 1799. *Recueil et parallèle des édifices de tout genre anciens et modernes*. Gille, Paris.
- P. Duthilleul. 1958. "Les reliques de Clément de Rome", *Revue des Études Byzantines* 16, 85-98.
- R. Eitelberger von Edelberg. 1863. "Altchristliche Fresken in der Kirche S. Clemente zu Rom entdeckt in dem Jahren 1861 und 1863", *Mitteilungen der K.K. Central-Commission* 8, 301-308.
- S. Fra Santi. 1588. *Le cose meravigliose dell'alma città di Roma....* Girolamo Francino, Venezia.
- A.P. Futaz. 1962. *Le Piante Di Roma*. Istituto Studi Romani, Roma.
- G. Gatti. 1933. "Titulus Clementis", *Bullettino di archeologia cristiana* 61.
- H. Geertman. 1988. "L'illuminazione della basilica paleocristiana secondo il Liber Pontificalis", *Rivista di archeologia cristiana* 64, 135-160.
- H. Geertman. 1968-1969. "Ricerche sopra la prima fase di S. Sisto Vecchio in Roma", *APARA* 41, 219-228.
- J. Gordon Gray. 1900-1907. "The House and Basilica of S. Clemente on the Celian", *Journal of the British and American Archaeological Society of Rome*.
- C. Faldi Gugliemi. 1966. *Tesori d'arte cristiana 12. Roma/S. Clemente*. Carlino, Bologna.
- F. Guidobaldi. 2007. "Una domus tardoantica e la sua trasformazione in chiesa dei SS. Quirico e Giulitta" in *Res Bene Gestae : ricerche di storia urbana su Roma antica in onore di Eva Margareta Steinby*. Quasar, Roma.
- F. Guidobaldi. 2000. *Le organizzazioni dei titoli nello spazio urbano in Christiano loco - Lo spazio cristiano nella Roma del primo millennio*. Fratelli Palombi editori s.r.l., Roma.
- F. Guidobaldi. 1999. "Le domus tardoantiche di Roma come "sensori" delle trasformazioni culturali e sociali" in *The Transformation of VRBS ROMA in Late Antiquity*, ed. W. V. Harris. JRA, Portsmouth, RI.
- F. Guidobaldi. 1997. "Gli scavi del 1993-95 nella Basilica di S. Clemente a Roma e la scoperta del battistero paleocristiano. Nota preliminare", *Rivista di archeologia cristiana* 73, 459-491.
- F. Guidobaldi. 1993. "Titulus Clementis" in *LTUR I*, ed. E.M. Steinby. Edizione Quasar, Roma.
- F. Guidobaldi. 1992. *San Clemente, gli edifici Romani, la basilica paleocristiana e le fasi altomedievali*. Collegio San Clemente, Roma.
- Federico Guidobaldi, *L'inserimento delle chiese titolari di Roma nel tessuto urbano preesistente: osservazioni ed implicazioni*, *Quaeritur inventus colitur*, Studi di Antichità Cristiana 40, Città del Vaticano 1989.
- Federico Guidobaldi, *Ricerche di archeologia cristiana a Roma (dentro le mura)*, *Congrès International d'Archéologie Chrétienne*, Lion-Vienne-Grenoble-Genève-Aoste

- 1986, Città del Vaticano 1989, vo. III.
- F. Guidobaldi. 1986. “L’edizia abitiva unifamiliare nella Roma tardoantica” in *Società romana e Impero tardoantico vol II “Roma, politica, economia, paesaggio urbano”*, ed. A. Giardina. Laterza, Bari.
  - F. Guidobaldi. 1985. *Scavi 1981-82 nell’area del Convento di S. Clemente*, Roma - in *Archeologia nel centro*, Roma.
  - Federico Guidobaldi, *Scavi nell’area del convento di S. Clemente (1981-1982) in Roma - Archeologia nel centro*, De Luca editore 1985, Roma
  - F. Guidobaldi. 1983. “Gli scavi di S. Clemente a Roma”, *Archeologia viva* 1/10.
  - F. Guidobaldi. 1978. *Il complesso archeologico di S. Clemente. Risultati degli Scavi piu recenti e riesame dei resti architettonici*. Collegio San Clemente, Roma.
  - F. Guidobaldi and A. Guiglia Guidobaldi (eds.). 2002. *Ecclesiae Atti del congresso internazionale di studi sulle chiese di Roma (IV-X secolo) Vol. I-III*. Pontificio Istituto di archeologia cristiana, Città del Vaticano.
  - F. Guidobaldi, C. Barsanti and A. Guiglia Guidobaldi. 1992. *San Clemente – La scultura del VI secolo*. Collegio San Clemente, Roma.
  - F. Guidobaldi and A. Guiglia Guidobaldi. 1983. *Pavimenti marmorei di Roma dal IV al IX secolo*. Pontificio Istituto di archeologia cristiana, Città del Vaticano.
  - C. Hibbert. 1985. *Rome - The Biography of a City*. Penguin Books, London.
  - C. Hessel. 1869. *Die altchristlichen Basiliken Roms – insbesondere die Basilika San Clemente*. Pfeil, Marburg.
  - J.N. Hill and R.K. Evans. 1972. “A model for classification and typology” in *Models in Archaeology*, ed. D.L. Clarke. Methuen, London.
  - J. Hillner. 2007. “Families, patronage, and titular churches of Rome, c. 300-c.600” in *Early Christian Rome, 300-900*, ed. K. Cooper and J. Hillner. Cambridge University Press, Cambridge.
  - M. Humphries. 2007. “From Emperor to pope? Ceremonial, space and authority at Rome from Constantine to Gregory the Great in Religion, Dynasty, and Patronage” in *Early Christian Rome, 300-900*, ed. K. Cooper and J. Hillner. Cambridge University Press, Cambridge.
  - T. Immonen. 2012. *Building the Cassinese Monastic Identity. A Reconstruction of the Fresco Program of the Desiderian Basilica (1071)*. PhD dissertation, University of Helsinki.
  - M.J. Johnson. 2009. *The Imperial Mausoleum in Late Antiquity*. Cambridge University Press, New York, NY.
  - E. Junyent. 1938. “Nuove indagini sotto la basilica primitiva di S. Clemente”, *Rivista di archeologia cristiana* 15, 147-152.
  - E. Junyent. 1932. *Il titolo di S. Clemente*. Pontificio Istituto di archeologia cristiana, Roma.
  - E. Junyent. 1930. “La basilica superior del títol de Sant Clement de Roma i les seves reformes successives”, *Analecta sacra tarraconensia* 6, 251-293.
  - E. Junyent. 1929. “Els primitius orígens i desenrotllament del títol de Sant Clement de Roma”, *Analecta sacra tarraconensia* 5, 321-340.

- E. Junyent. 1928. *La primitiva basilica di S. Clemente e le costruzioni antiche circostanti*. Pontificio istituto di archeologia cristiana, Roma.
- M. Kaser. 1975 [1971]. *Das Römische Privatrecht I & II*. C.H. Beck Verlag, München.
- P.F. Kirsch. 1918. *Die Römische Titelkirchen in Altertum*. F. Schöningh, Paderborn.
- J.P. Kotroman. 1949. *The Basilica of S. Clemente*, Apollo Magazine 1949.
- R. Krautheimer. 1986. *Early Christian and Byzantine Architecture*. Yale University Press, New Haven, CT.
- R. Krautheimer. 1983. *Three Christian Capitals: Topography and Politics*. University of California Press, Berkeley, Los Angeles, CA, London.
- R. Krautheimer. 1980a. *Rome: Profile of a City, 312 – 1308*. Princeton University Press, Princeton, NJ.
- R. Krautheimer. 1980b. *Corpus Basilicarum Christianarum Romae Vol. V*. Pontificio Istituto di archeologia cristiana, Roma.
- R. Krautheimer. 1976. *Corpus Basilicarum Christianarum Romae Vol. IV*. Pontificio Istituto di archeologia cristiana, Roma.
- R. Krautheimer. 1971. *Corpus Basilicarum Christianarum Romae Vol. III*. Pontificio Istituto di archeologia cristiana, Roma.
- R. Krautheimer. 1962. *Corpus Basilicarum Christianarum Romae Vol. II*. Pontificio Istituto di archeologia cristiana, Roma.
- R. Krautheimer. 1939. *Corpus Basilicarum Christianarum Romae Vol. I*. Pontificio Istituto di archeologia cristiana, Roma.
- A.D. Krieger. 1944. “The typological concept”, *American Antiquity* 9, 271-288.
- A. Kurdock. 2007. “Anicia Demetria and the missing Patron in Religion, Dynasty, and Patronage” in *Early Christian Rome, 300-900*, ed. K. Cooper and J. Hillner. Cambridge University Press, Cambridge.
- H. Laag. 2001. *Kleines Wörterbuch der frühchristlichen Kunst und Archäologie*. Reclam, Stuttgart.
- R. Lanciani. 1902-1912. *Storia degli Scavi di Roma. E. Loeschler & Co*, Roma.
- R. Lanciani. 1896. *Forma Urbis Romae*. Hoepli, Milano.
- B. Lançon. 2001. *Rome in Late Antiquity*. Routledge, New York.
- A.D. Lee. 2000. *Pagans Christians in Late Antiquity*. Routledge, London and New York, NY.
- T. Lehmann. 2007. “Übelegungen zur Bestattung im spätantiken Kirchenbau: Die Beispiele Cimitile, Rom und Trier” in *Der basilikale Komplex in Cimitile: Ein Weltkulturerbe?*, ed. M. de Matteis and A. Trinchesi. Athena, Oberhausen.
- T. Lehmann. 2004. *Paulinus Nolanus und die Basilica Nova in Cimitile/Nola*. Reichert Verlag Wiesbaden, Wiesbaden.
- W. Lentz. 1975. “Some peculiarities not hitherto fully understood of “Roma” Mithraic sanctuaries and representations”, in *Mithraic Studies. Proceedings of the First International Congress of Mithraic Studies, Vol. 2*, ed. J. Hinnels. Manchester University Press, Manchester.
- C. Leyser. 2007. “‘A church in the house of saints’: property and power in the Passion



of John and Paul” in *Early Christian Rome, 300-900*, ed. K. Cooper and J. Hillner. Cambridge University Press, Cambridge.

- I. B. Lippolis. 2005. *L'architettura residenziale nelle città tardoantiche*. Carocci, Torino.

- R. Luciani and S. Settecesi. 1996. *San Crisogono*. Fratelli Palombi editori, Roma.

- J. Mabillon, O.S.B. 1689. *Musei italici, Tomus II. Complectens antiquos libros rituales sanctae romanae ecclesiae. cum commentario previo in ordinem romanum*. Luteciae Parisiorum.

- T. Magnusson. 2004. *The Urban Transformation of Medieval Rome - 312-1420*. Suecoromana, Stockholm.

- C. Mango. 1986. *Le développement urbain de Constantinople*. Collège de France, Paris.

- T.F. Matthews. 1962. “An Early Roman Chancel Arrangement and its Liturgical Uses”, *Rivista di archeologia cristiana* 38, 73–95.

- G. Matthiae, *Le chiese di Roma dal IV al X secolo*, Roma Cristiana 3, Bologna 1962.

- G. Matthiae, *Basiliche paleocristiane con ingresso a polifora*, Bolletino d'Arte 1957.

- R. Meiggs. 1997. *Roman Ostia*. Oxford, Oxford University Press.

- R. Milburn. 1988. *Early Christian Art and Architecture*. Scolar Press, Aldershot.

- C.R. Morey. 1953. *Early Christian Art – An Outline of the Evolution of Style and Iconography in Sculpture and Painting from Antiquity to the Eighth Century*. Princeton University Press, Princeton, NJ.

- T. Morrison. 2011. *Isaac Newton's Temple of Solomon and his Reconstruction of Sacred Architecture*. Springer, Birkhäuser.

- R. MacMullen. 1984. *Christianizing the Roman Empire A.D. 100-400*. Yale University Press, New Haven, CT.

- R. MacMullen and E.N. Lane. 1992. *Paganism and Christianity 100-425 C.E.* Fortress Press, Minneapolis.

- J. Mullooly. 1896. *Saint Clement, Pope and Martyr, and his Basilica in Rome*. Benedict Guerra, Roma.

- L. Mumford. 1979. *The City in History*. Penquin Books, London.

- L. Nolan. 1910. *The Basilica of S. Clemente in Rome*. M. Bretschneider, Roma.

- L. Nolan. 1914. *S. Clemente Tunnel*. Boston.

- J. Osborne. 1984. *Early Mediaeval Wall-Painting in the Lower Church of San Clemente, Rome*. Garland Press, New York, NY.

- J. Osborne. 1982. “The Christological Scenes in the nave of the lower church of San Clemente, Rome” in *Medieval Lazio: Studies in Architecture, Painting and Ceramics*, ed. D. Whitehouse. British Archaeological Reports, Oxford.

- J. Osborne. 1982. “Early medieval wallpainting in the church of San Clemente, Rome: the Libertinus cycle and its date”, *Journal of the Warburg and Courtauld Institutes* 45, 182-185.

- J. Osborne. 1981. “Early medieval wallpainting in San Clemente, Rome: The Madonna and Child in the niche”, *Gesta* 20, 299-310.

- J. Osborne. 1981. “The “Particular Judgement”: an early medieval wallpainting in the lower church of San Clemente, Rome”, *The Burlington Magazine* 123, 335-341.

- J. Osborne. 1981. "The painting of the Anastasis in the lower church of San Clemente, Rome: a re-examination of the evidence for the location of the tomb of St. Cyril", *Byzantion* 51, 255-287.
- J. Osborne. 1979. "The portrait of Pope Leo IV in S. Clemente, Rome: a re-examination of the so-called 'square nimbus' in medieval art", *Papers of the British School at Rome* 47, 58-65.
- J. Osborne. 1979. *Early Medieval wallpaintings in the lower church San Clemente, Rome*. PhD dissertation, The Courtauld Institute, London.
- Letizia Pani Ermini. 2001. *Forma Urbis: lo spazio urbano tra VI e IX secolo in Roma nell'alto medioevo*. Centro Italiano di studi sull'alto medioevo, Spoleto.
- Letizia Pani Ermini. 2000. "Lo "spazio cristiano" nella Roma del primo millennio", in *Cristiano nella Roma del primo millennio*. Fratelli Palombi editori, Roma.
- E. Panofsky. 1972. *Renaissance and Renascences in Western Art*. Icon Editions, New York, NY.
- C. Pavia. 1999. *Guida dei mitrei di Roma antica - Dai misteriosi sottoterranei della Capitale oro, incenso e Mithra*. Gangemi editore, Roma.
- Pensabene, Patrizio. 2015. *Roma su Roma. Reimpiego architettonico, recupero dell'antico e trasformazioni urbane tra il III e il XIII secolo*. Pontificio Istituto di archeologia cristiana, Città del Vaticano.
- J.M. Petersen, *House Churches in Rome*, *Vigilae Christianae* 23, 1969.
- A. Philipsborn. 1954. "Der Begriff der Juristischen Person im Römischen Recht", *Zeitschrift der Savigny-Stiftung für Rechtsgeschichte* 71, 41-70.
- Ch. Pietri. 1978. "Recherches sur les domus ecclesiae", *Revue des études augustiniennes* 24, 3-21.
- Ch. Pietri. 1977. "Appendice prosopographique à la "Roma Cristiana"", *Mélanges d'archéologie et d'histoire de l'École Française de Rome: Antiquité* 89, 311-440.
- Ch. Pietri. 1976. *Roma christiana. Recherches sur l'Église de Rome, son organization, sa politique, son idéologie de Miltiade à Sixte III (311-440)*. École française de Rome, Rome.
- Ch. Pietri and Luce Pietri (eds.). 2005. *Die Geschichte des Christentums - Religion, Politik, Kultur Vol. I-III (GC)*. Herder, Münster.
- S.B. Platner and Th. Ashby. 1929. *A Topographical Dictionary of Ancient Rome*. Oxford.
- N. Purcell. 1999. "The populace of Rome in late Antiquity: problems of classification and historical description" in *The Transformation of VRBS ROMA in Late Antiquity*, ed. W. V. Harris. JRA, Portsmouth, RI.
- P. Reilly. 1991. "Towards a virtual archaeology" in *Computer Applications in Archaeology*, ed. K. Lockyear and S. Rahtz. British Archaeological Reports, Oxford.
- J. De Reu et al. 2014. "On introducing an image-based 3D reconstruction method in archaeological excavation practice", *Journal of Archaeological Science* 41, 251-262.
- G. Rickman. 1971. *Roman Granaries and Store Buildings*. Cambridge University Press, Cambridge.
- E. Rodriguez Almeida. 1981. *Forma Urbis Marmorea. Aggiornamento generale 1980*. Roma.

- Th. Roller. 1873. "Saint-Clément de Rome", *Revue Archéologique* 25, 289-299.
- F. Rondini. 1706. *De S. Clemente Papa et Martyre, eiusque Basilica in Urbe Roma*. Franciscum Gonzagam, Roma.
- E. Russo. 1989. "Due frammenti, la filologia, una chiesa: ricomposto un pluteo di S. Clemente a Roma", in *Studi in memoria di Giuseppe Bovini*. Biblioteca di Felix Ravenna, Ravenna.
- L. Richardson Jr. 1992. *A New Topographical Dictionary of Ancient Rome*. Johns Hopkins University Press, Baltimore, MD.
- O.F. Robinson. 1992. *Ancient Rome: city planning and administration*. Routledge, London.
- G.B. De Rossi. 1870. "I monumenti scoperti sotto la basilica di S. Clemente studiati nella loro - successione stratigrafica e cronologica", *Bullettino di archeologia cristiana* 2.Ser.1., 129-168.
- G.B. De Rossi, *Scoperta di un insigne speleo mitriaco sotto l'antica basilica di S. Clemente*, *Bullettino di archeologia cristiana* 2a S. 1, 1870.
- G.B. De Rossi, *Roma, Basilica di S. Clemente*, *Bullettino di archeologia cristiana* 3 1865
- G. B. Rossi. 1863. "Le pitture scoperte in S. Clemente", *Bullettino di archeologia cristiana*.
- G.B. De Rossi. 1863. "Del sepolcro di S. Cirillo nella basilica di S. Clemente", *Bullettino di archeologia cristiana* 1, 9-14.
- G.B. De Rossi, *Scavi nella basilica di S. Clemente*, *Boll. Archeol. Crist.* 1 1863.
- G.B. De Rossi, *Prime origini della basilica di S. Clemente*, *Bullettino di Archeologia Cristiana* 1 1863.
- M. Salzman. 1999. "The Christianization of sacred time and sacred space" in *The Transformation of VRBS ROMA in Late Antiquity*, ed. W. V. Harris. JRA, Portsmouth, RI.
- V. Saxer. 2001a. *La Chiesa di Roma dal V al X secolo: amministrazione centrale e organizzazione territoriale, Roma nell'alto medioevo. Settimane di studio del centro italiano di studi sull'alto medioevo XLVIII, Tomo secondo*. Presso la Sede del centro, Spoleto.
- V. Saxer. 2001b. *Sainte-Marie-Majeure. Une basilique de Rome dans l'histoire de la ville et de son église*. École française de Rome, Rome.
- S. Schrenk. 1999. "Spätantik-frühislamische Textilien in der Studiensammlung des F. J. Dölger-Instituts", *JAC* 42, 72-115.
- F. Sear. 1989. *Roman Architecture*. Cornell University Press, Ithaca, NY.
- R. Staccioli. 1962. "Tipi di horrea nella documentazione della Forma Urbis" in *Hommage à Albert Grenier*. Collection Latomus, Bruxelles.
- K. Sessa. 2007. "Domestic conversions: household and bishops in the late antique 'papal legends'" in *Early Christian Rome, 300-900*, ed. K. Cooper and J. Hillner. Cambridge University Press, Cambridge.
- A. Stauffer. 1995. *Textiles of Late Antiquity*. The Metropolitan Museum of Art, New York.
- E.M. Steinby (ed.). 2012. *Lacus Iuturnae II. Saggi degli anni 1982-85*. Institutum

Romani Finlandiae, Roma.

- E.M. Steinby (ed.). 1993. *LTUR I-V*. Edizione Quasar, Roma.
- P. Thonemann (ed.). 2013. *Monumenta Asiae Minoris Antiqua Vol. XI: Monuments from Phrygia and Lykaonia recorded by M.H. Ballance, W.M. Calder, A.S. Hall and R.D. Barnett*. Roman Society Publications, London.
- H.G. Thûmmel. 2002. "Das Apsismosaik von San Clemente in Rom" in *Ecclesiae Urbis: ACISCR (IV-X secolo), Roma, 4-10 settembre 2000*, ed. F. Guidobaldi and A. Guiglia Guidobaldi. Pontificio Istituto di archeologia cristiana, Roma.
- Tor Arc. Presb. tituli Sanctae Caeciliae, *The Basilica of Santa Cecilia in Rome*, Edizioni d'Arte Marconi 2010, Genova,
- H. Toubert. 1976. "Rome et le Mont – Cassin: nouvelles remarques sur les freques de l'église inférieure de Saint-Clément de Rome", *Dumbarton Oaks Papers* 30, 1-33.
- Dennis E. Trout, *Cimitile, Nola, and the Transformation of the City in Late Antiquity in Cimitile: Ein Weltkulturerbe?*, ed. Mario de Matteis and Antonio Trinchese, Athena2007, Oberhausen
- K. Tuori 2015. "Investigating public and private in the Roman house" in *Public and Private in the Roman House and Society*, ed. K. Tuori and L. Nissin. JRA, Portsm., RI.
- J. Vaes. 1980. "Alcune considerazioni archeologiche sulla cristianizzazione degli edifice antichi a Roma", *Acta Archaeologica Lovaniensia* 19, 49-65.
- B. Ward-Perkins. 2002. *From Classical Antiquity to the Middle Ages – Urban Public Building in Northern and Central Italy AD 300-850*. Oxford University Press, Oxford.
- J.B. Ward-Perkins. 1994. *Roman Imperial Architecture*. Yale University Press, New Haven, CT.
- K. Weitzmann (ed.). 1979. *Age of Spirituality – Late Antique and Early Christian Art, Third to Seventh Centuries*. Princeton University Press, Cambridge, MA.
- R. Whallon and J.A. Brown (eds.). 1982. *Essays on Archaeological Typology*. Center for American Archaeology Press, Evanston.
- M.J. Vermaseren. 1956-1960. *Corpus inscriptorum et monumentorum religionis mithriacae*. Martinus Nijhoff, The Hague.
- M.J. Vermaseren. 1950. *Het Mithraeum onder Kerk van S. Clemente*. Het Koninklijk Nederlands Instituut te Rome, Rome.
- M. Wheeler. 2001. *Roman Art & Architecture*. Thames & Hudson, London.
- L.M. White. 1990. *Building God's House in the Roman World – Architectural Adaption among Pagans, Jews and Christians. Vols. I-II*. The Johns Hopkins University Press, Baltimore, MD and London.
- L.M. White. 1997. *The Social Origins of Christian Architecture Volume I*. Trinity Press International, Valley Forge USA.
- L. Michael White, *The Social Origins of Christian Architecture Volume II*, Trinity Press International 1997, Valley Forge USA.
- E.-M. Viitanen. 2010. *Locus Bonus - The Relationship of the Roman Villa to its Environment in the Vicinity of Rome*. Helsinki University Print, Helsinki.
- A. M. Yasin. 2010. *Saints and Church Spaces in the Late Antique Mediterranean - Architecture, Cult and Community*. Cambridge University Press, New York, NY.

## 7 List of illustrations

The drawings, maps and tables are made by the author. The figures are authors unless mentioned otherwise.

### Drawings

Drawing I, The current situation, site plan 1:1500, Juhana Heikonen

Drawing II, The archaeological evidence for the structures that were probably still in use at the beginning of the fifth century, site plan 1:1500, Juhana Heikonen

Drawing III, The digitized Giovanni Battista Noll Map of 1748, site plan 1:1500, Juhana Heikonen

Drawing IV, The Nolli Map with the archaeological remains and hypothesis, site plan 1:1500, Juhana Heikonen

Drawing V, The reconstruction of the site plan of early fifth century, site plan 1:1500, Juhana Heikonen

Drawing VI, The reconstruction plan, plan 1:200, Juhana Heikonen

Drawing VII a,b,c and d, The reconstruction section, section 1:200, Juhana Heikonen

Drawing VIII, Axonometric view of the 3D reconstruction model, perspective, Juhana Heikonen

Drawing IX, A view from the atrium from the 3D reconstruction model, perspective, Juhana Heikonen

Drawings Xa, b and c, A view from the nave to the apse from the 3D reconstruction model, perspective, Juhana Heikonen

Drawing XI, Phase II, Juhana Heikonen

Drawing XII, Phase IV, Juhana Heikonen

Drawing XIII, Phase V, Juhana Heikonen

Drawing XIV, The site ca. 100. , Juhana Heikonen

Drawing XV, The site ca. 400. , Juhana Heikonen

Drawing XVI, The site ca. 1150. , Juhana Heikonen

Drawing XVII, The site ca. 1300. , Juhana Heikonen

Drawing XVIII, The site ca. 1450. , Juhana Heikonen

Drawing XIX, The site ca. 1600. , Juhana Heikonen

Drawing XX, The site ca. 1750. , Juhana Heikonen

Drawing XXI, The Forum Romanum, Juhana Heikonen

Drawing XXII, Domus Flavia, Juhana Heikonen

Drawing XXIII, Casa del Tramezzo di Legno, Herculaneum, Juhana Heikonen

Drawing XXIV, Domus della Fortuna Annonaria, Ostia, Juhana Heikonen

Drawing XXV, Villa Romana sel Piazza Armerina, Sicily, Juhana Heikonen

Drawing XXVI, Paulinus' Basilical Complex ca. 400, Cimitile, Juhana Heikonen

Drawing XXVII, SS. Quattro Coronati, Rome, Juhana Heikonen

Drawing XXVIII, Santa Prisca, Rome, Juhana Heikonen

## Maps

Map I, The Constantinian Rome, Juhana Heikonen

Map II, The mithraeums, Juhana Heikonen

Map III, The Domus, Juhana Heikonen

Map IV, The Churches, Juhana Heikonen

Map V, The Churches from the 4th to 6th Centuries, Juhana Heikonen

## Tables

Table I, The Roman Basilicas, Juhana Heikonen

Table II, Some Mediterranean Basilicas as set in Groups, Juhana Heikonen

Table III, the Domus, Juhana Heikonen

Table IV, The Churches, Juhana Heikonen

Table V, List of churches 200-550 attributed to pope, Juhana Heikonen

## Figures

All figures by the author, except 1.1.01, 1.1.02, 1.1.03, 1.1.04 and 1.1.05.

Fig. 0.01. The San Clemente gatehouse seen from the Piazza San Clemente.

Fig. 0.02. San Clemente's façade designed by Carlo Stefano Fontana (1713-19).

Fig. 0.03. The nave and the remodeled *schola cantorum* which originally dates from the first half of 6th century.

Fig. 0.04. The apse mosaic.

Fig. 0.05. The scale model (1/10) of the 6th to 8th century Baouit monastery basilica in Egypt built by Jean-Claude Golvin and Denis Delpalillo in the Louvre.

Fig. 0.06. The scale model (1/10) of the 6th to 8th century Baouit monastery basilica in Egypt built by Jean-Claude Golvin and Denis Delpalillo in the Louvre.

Fig. 0.07. The actual architectural detailing (capitals, paintings, etc.) displayed to scale 1:1 in the Louvre.

Fig. 1.1.01. Lanciani's *Forma Urbis Romae* and San Clemente (1901).

Fig. 1.1.02. Richard Krautheimer's façade reconstruction from CBCR.

Fig. 1.1.03. Richard Krautheimer's isometric cut-through reconstruction of San Clemente in *Early Christian and Byzantine Architecture* (1986). The reconstruction of the *polifora/narthex* does not show the middle arch as larger than the others.

Fig. 1.1.04. Federico Guidobaldi's reconstruction plan with the later *schola cantorum* in Guidobaldi 1992, Tav. XVIII.

Fig. 1.1.05. Federico Guidobaldi's reconstruction section with the upper and lower basilicas in Guidobaldi 1992, Tav. XVII.

Fig. 1.3.01. Room A1 in the *horrea* showing the outer envelope of *opus quadratum* and the load bearing walls in *opus mixtum* that carry the vaulting.

Fig. 1.3.02. Room Y in the *horrea* showing the load-bearing walls in *opus mixtum* that carry the vaulting. The narrow doorway is 19th century.

Fig. 1.3.03. Room M or the *Mithraeum* showing the benches for the mithraic rites and the location of the altar.

Fig. 1.3.04. *Cryptoporticus* CE and a blocked doorway (2nd century).

Fig. 1.3.05. Room AM or the anteroom to the *Mithraeum* showing one of the decorated pillars.

Fig. 1.3.06. The narrow fire alley between the *horrea* and the *domus* showing the barrel vaulting resting on the *opus quadratum* of the *horrea*.

Fig. 1.3.07. The Colosseum.

Fig. 1.3.08. Scale model of the Colosseum in the Museo della Civiltà Romana.

Fig. 1.3.09. Scale model of the Ludus Magnus in the Museo della Civiltà Romana.

Fig. 1.3.10. The north aisle of the Lower Church showing the remaining *spolia* columns.

Fig. 1.3.11. The south aisle of the Lower Church.

Fig. 1.3.12. The north aisle wall of the Upper Church showing the clerestory wall of the Lower Church.

Fig. 1.3.13. The reassembled *schola cantorum* in the Upper Church. On the right the crest of bishop Mercurius.

Fig. 1.2.14. The baptismal font of the 6th century showing how nearly all the *opus sectile* was scrapped during the building of the Upper Church. Similar scrapping probably happened to other previous Phases.

Fig. 1.3.15. The *quadriporticus* of the Upper Church with the *spolia* columns.

Fig. 2.1.01. Forum Romanum.

Fig. 2.1.02. The basilica in Trier.

Fig. 2.1.03. Basilica Maxentii in Rome.

Fig. 2.2.01. The remains of the *deambulatorio*-basilica next to Santa Costanza.

Fig. 2.2.02. Santa Costanza and the arches that provide a focal point for the viewer by having a larger arch. The same is applied in the *poliforas* and also in the reconstructions of San Clemente in Chapter 4.

Fig. 2.2.03. San Paolo fuori le Mura has one of the few interiors, even though heavily rebuilt that provides a sense of what the interior of the large, secular basilicas would have been like.

Fig. 2.2.04. Santa Sabina and showing clerestory windows that are used in Chapter 4. The windows were part of the other restoration work carried by the architect and art historian Antonio Muñoz in the 1920s.

Fig. 2.2.05. Nave of Santa Sabina.

Fig. 2.2.06. Santa Sabina clerestory wall and the remains of the *opus sectile* decoration that is partly used in Chapter 4.

Fig. 2.2.07. Santa Sabina lattices designe by Antonio Muñoz according to archaeological data found on site..

Fig. 2.2.08. Santa Maria Maggiore and the remaining early Christian mosaics in the clerestory wall that are partly used in Chapter 4. The classical appearance is underlined with the use of architraves instead of arches. The spiraling acanthus-motif in the architrave ties the decoration to the other examples in Chapter 4.2.

Fig. 2.2.09. Santa Maria Maggiore, view to the entrance.

Fig. 2.2.10. Santa Maria Maggiore, detail of the columns and clerestory wall.

Fig. 2.2.11. Santi Quattro Coronati, the Carolingian gatehouse.

- Fig. 2.2.12. Santi Quattro Coronati, the Carolingian northern clerestory wall and columns.
- Fig. 2.2.13. Santa Cecilia. One of the early Christian churches in Trastevere.
- Fig. 2.2.14. Santi Giovanni e Paolo. The narthex is from 1158, but the five arches in the upper part of the nave were restored visible in the 20th century. The five arches repeat the same theme seen in late antique architecture, i.e., making the central arch larger than the rest.
- Fig. 2.2.15. Santa Prisca. The site of the early Christian church built on top of a *domus* (Drawing XXVIII).
- Fig. 2.2.16. Sant'Agnese fuori le mura. One of the few churches in Rome with an *emporio* over the aisles.
- Fig. 2.2.17. Chiesa della SS. Annunziata in Paestum. This heavily restored small basilica shows the early Christian space without decoration. The basilica is from the beginning of the 5th century and was built with a *polifora*, which was subsequently closed a century later. In my opinion this basilica and Paulinus' nearby basilical complex at Nola illustrates the short "fashion" of open *poliforas*.
- Fig. 2.2.18. Basilica di Sant'Apollinare Nuovo, façade.
- Fig. 2.2.19. Basilica di Sant'Apollinare Nuovo, nave and the clerestory mosaics.
- Fig. 2.2.20. San Simpliciano or, Basilica Virginum commissioned by St. Ambrose in Milan. The original clerestory windows are the same size as those in San Clemente but not the "keyhole"-version.
- Fig. 2.2.21. Sant'Ambrogio or the Basilica Martyrium that is mentioned in Chapter 3.3.
- Fig. 2.3.01. The basilical complex in Nola.
- Fig. 2.3.02. The shrine of Felix inside Paulinus' basilical complex.
- Fig. 2.4.01. The Palace of Theoderic in the clerestory mosaic of Sant'Apollinare Nuovo in Ravenna. The mosaic presents the combination of columns and curtains - the interior element that has been largely ignored in studies of late antique churches.
- Fig. 2.4.02. A Libyan 5th century church mosaic depicting a church with curtains. Louvre Ma3677.
- Fig. 2.4.03. A Libyan 5th century church mosaic depicting a church with curtains. Louvre Ma3676. As with Ma 3677 (Fig. 2.4.02) the mosaic depicts curtains that are tied back to provide access. The interesting factor is that they are used in doorways. This late antique evidence could also relate to the discussion of open and closed spaces in the Roman *domus*. The emphasis has been on the findings of hinges, etc. disregarding the fact that curtains might provide the answer. Unfortunately, the Italian climate and soil leave no traces of the curtains buried in Pompeii or Herculaneum.
- Fig. 2.4.04. A Libyan 5th century church mosaic depicting a church interior and altar with curtains. Louvre Ma5093.
- Fig. 2.4.05. Santa Maria Antiqua in Rome. The 6th century frescoes depict tapestries used as decoration. Another similar example can be found in San Marco by Piazza Venezia in Rome.
- Fig. 2.4.06. An early Christian curtain found by the French in the Baouit monastery in Egypt. The embroidered curtain depicts four women and the slaying of the dragon.



Louvre E 26794.

Fig. 2.4.07. An Egyptian border for a tapestry from the 5th or 6th century depicting a grapevine. Museum für Byzantinische Kunst, Staatliche Museen zu Berlin, Inv. 9067.

Fig. 2.4.08. A 5th or 6th century tapestry from Antinoupolis, Egypt. Louvre E29275 and E29278.

Fig. 2.4.09. A tapestry from Egypt depicting bacchanalia. Louvre AF5511.

Fig. 2.4.10. A selection of Coptic bronze church furnishings. The liturgical furnishings, such as candelabra, incense burners etc. are limited in the finds from Rome. However, it can be assumed, that these Coptic finds bear at least some resemblance to the Roman liturgical furnishings.

Fig. 2.4.11. A selection of Coptic bronze church furnishings. Reverse of Fig. 2.4.10.

Fig. 3.1.01. Casa del Fauno in Pompeii. There is still uncertainty on the function of the *aula* or *exedra* opening onto the peristyle.

Fig. 3.1.02. Domus Flavia's peristyle and the central feature (Drawing XXII). According to Guidobaldi, this could be the example that was mimicked in Rome in Late Antiquity.

Fig. 3.1.03. Hadrian's Villa in Tivoli, a scale model in the Villa Adriana museum. This villa would have been the prime example of the organization of the flowing open spaces that are also discussed in Chapter 3.2.

Fig. 3.1.04. Domus della Fortuna Annonaria in Ostia (see also Drawing XXIV). The *polifora* bears resemblance to the *narthex/polifora* in Roman churches. The open organization of space from the apsidal *aula* to the *peristyle* is typical of the late antique *domus*.

Fig. 3.1.05. Casa dei Fortuna Annonaria in Ostia (see also Drawing XXIV). The niches and the *nymphaeum*.

Fig. 3.1.06. The entrance to the Domus dei Protiro in Ostia. Casa dei Fortuna Annonaria is not the only *domus* with open spatial organization.

Fig. 3.1.07. Domus dell'Opus Sectile in Ostia (Porta Marina) and the *tablinum/aula/exedra* of the house in the Museo dell'Alto Medioevo in Rome. This *opus sectile* has also been used in the reconstructions in Chapter 4.

Fig. 3.1.08. The so-called Theodoric's Palace in Ravenna. The same architectural themes as found in early Christian churches are visible in the remaining façade.

Fig. 4.2.01. The baptistery in the Lateran with the acanthus motif dome and the flanking *opus sectile* decorations. Both of these motifs are used in the reconstructions in Chapter 4.

Fig. 4.2.02. The baptistery in the Lateran with the acanthus motif dome, detail.

Fig. 4.2.03. The baptistery in the Lateran with the *opus sectile*, detail.

Fig. 4.2.04. The recently reconstructed floor paneling of Santo Stefano Rotondo in Rome.

Fig. 4.2.05. The flooring of Santa Maria Antiqua in Rome.

Fig. 4.2.06. The Arian baptistery in Ravenna showing the combination of acanthus scrolls and *opus sectile*.

Fig. 4.2.07. The Arian baptistery in Ravenna showing the *opus sectile* decoration.

Fig. 4.2.08. The Arian baptistery in Ravenna showing the *opus sectile* decoration.

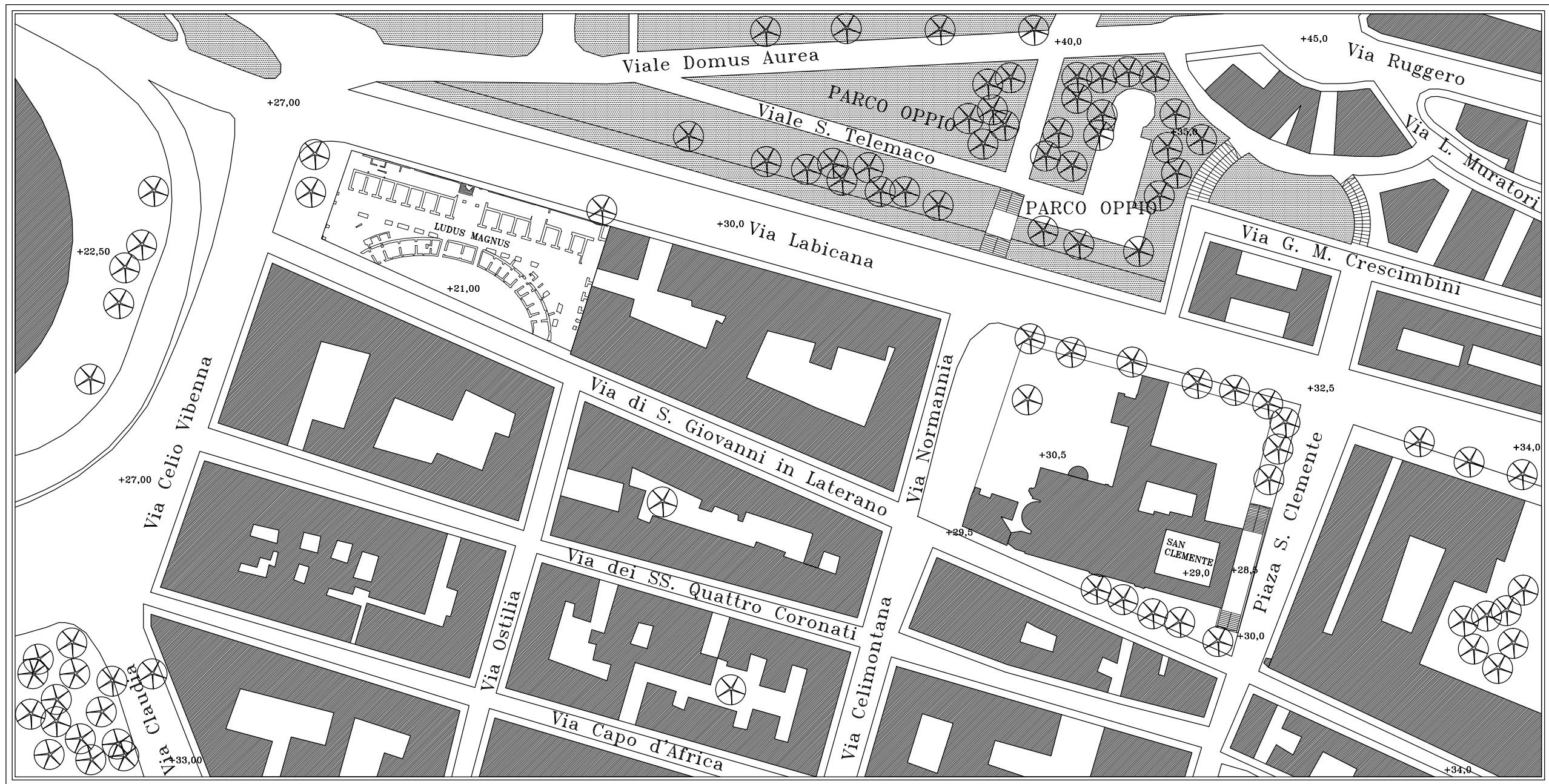
Fig. 4.2.09. The mausoleum of Galla Placidia in Ravenna showing the acanthus-motif.

Fig. 4.2.10. Paulinus' Basilica Nova in Cimitile showing the remaining *opus sectile* in the apse.

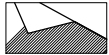

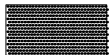
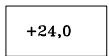

Fig. 4.2.11. Paulinus' Basilica Nova in Cimitile with the remaining *opus sectile* in the apse. Detail.

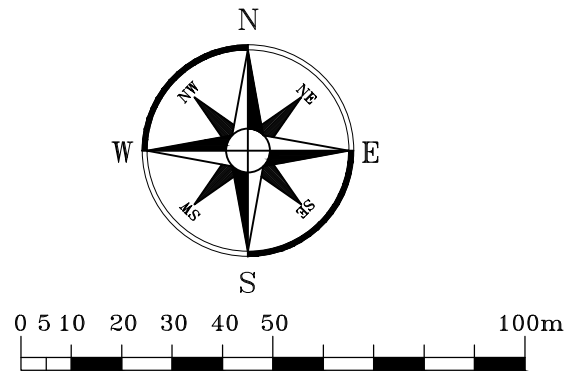
Fig. 4.2.12. Domus dell'Opus Sectile in Ostia (Porta Marina) and the *tablinum/aula/exedra* of the house in the Museo dell'Alto Medioevo in Rome. Detail.

## **8 Drawings, Maps and Tables**



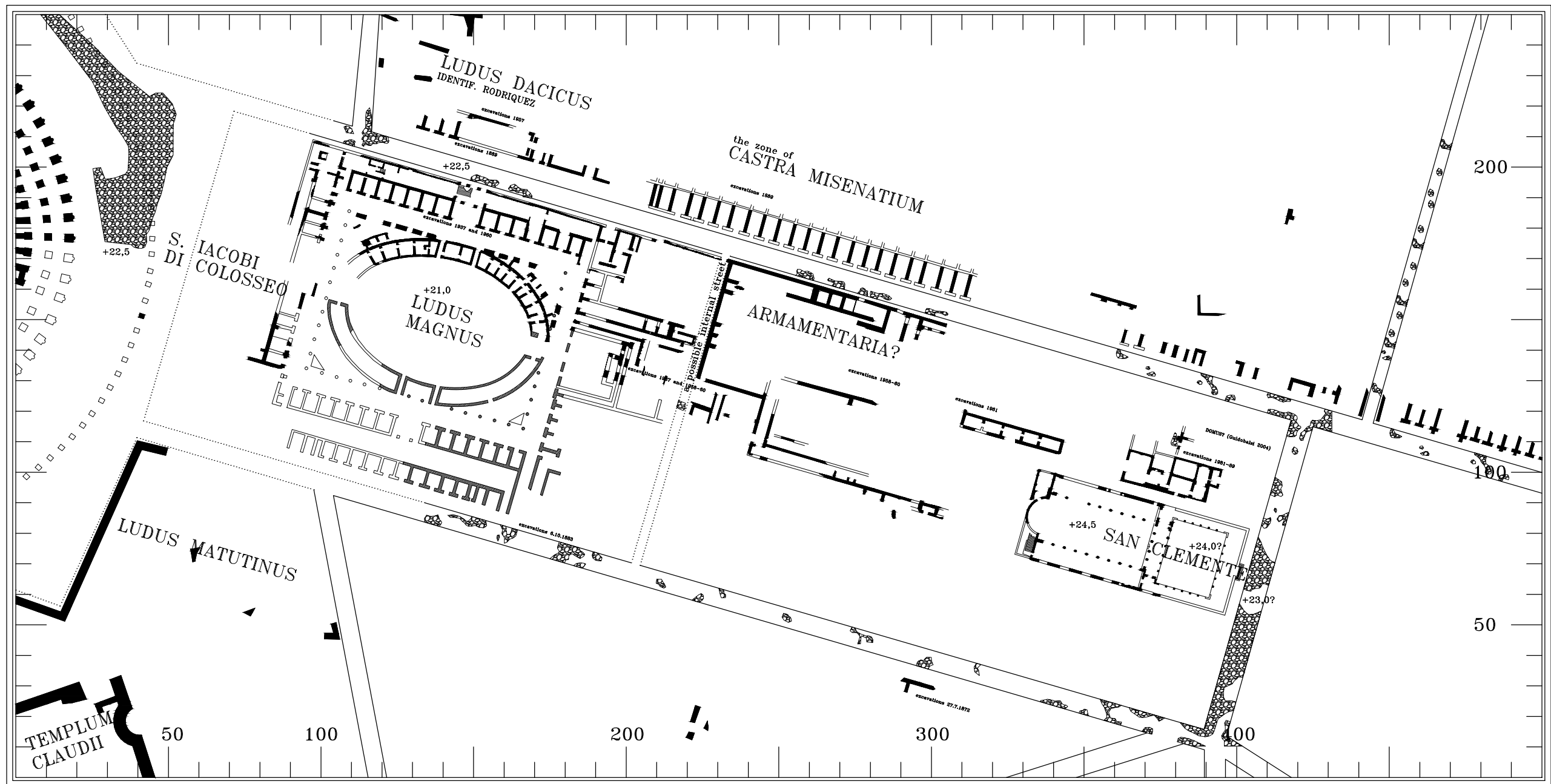
## LEGEND

-  Buildings
-  Archaeological remains (visible)
-  Park
-  +24.0 Altitude above sea level
-  Trees





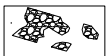
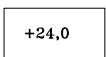


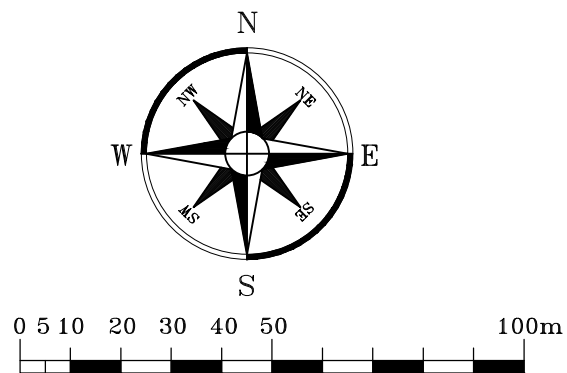
<h3 style="margin: 0;">San Clemente in Rome</h3> <p style="margin: 0;">A New Reconstruction of the Early 5th century Basilica and Its Origins</p>			
<b>Series:</b> The surroundings of San Clemente			
<b>Description:</b> The current situation			
<b>Reference:</b> Aerial view	<b>Type:</b> Siteplan	<b>Date:</b> 1.1.2010	<b>Scale:</b> 1:1500
<b>Copyright:</b> Juhana Heikonen Freesenkatu 3 A 10 00100 Helsinki Finland		Drawing I	





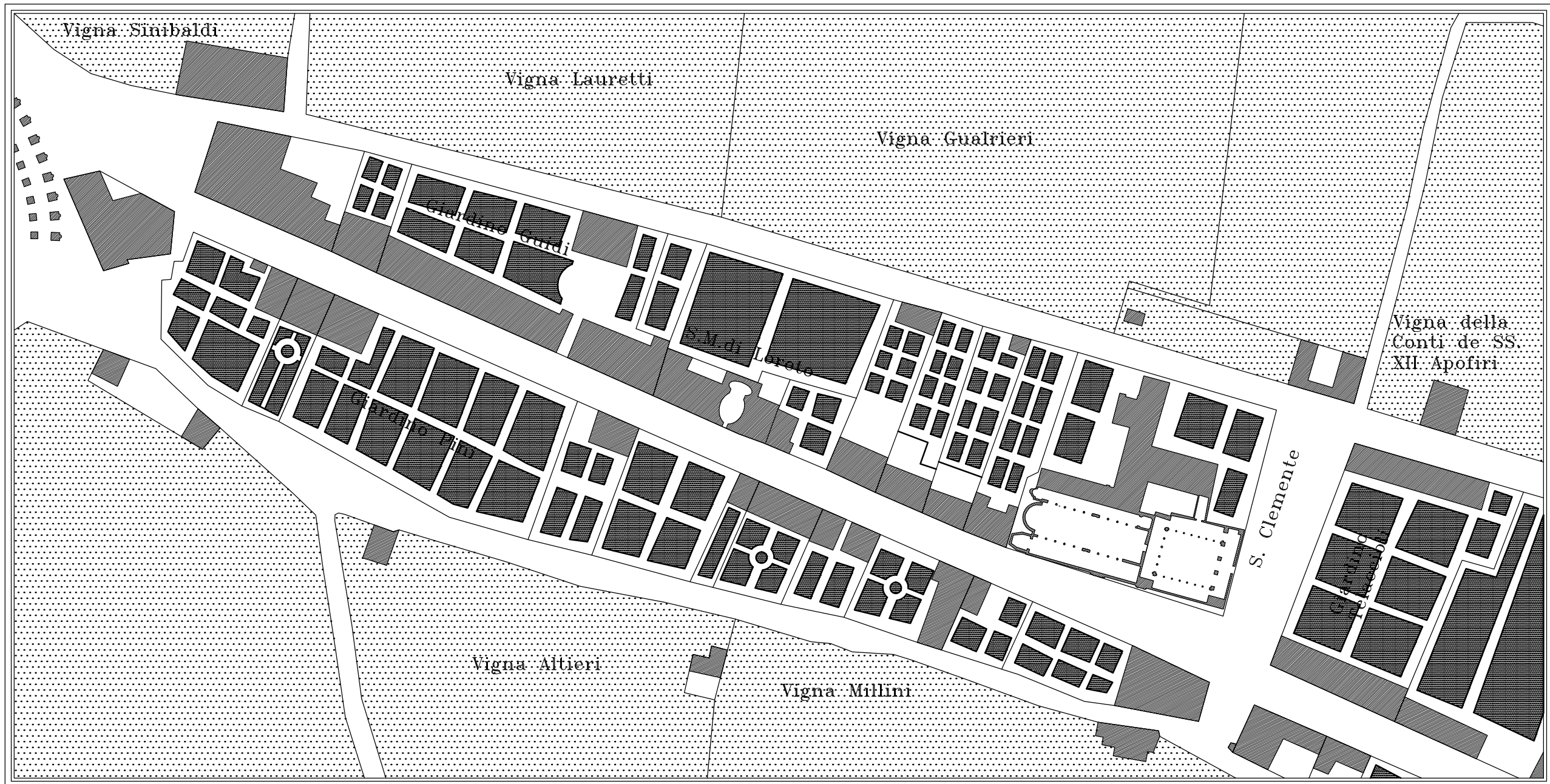
## LEGEND

-  Archaeological remains from ca. 400
-  According to the Severan Plan (3rd century)
-  Hypothetical of construction
-  Hypothetical street lines
-  Archaeological evidence for paved streets
-  Altitude above sea level  
Tolerance 0.5m, ?=hypothesis

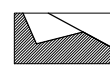




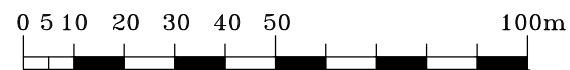
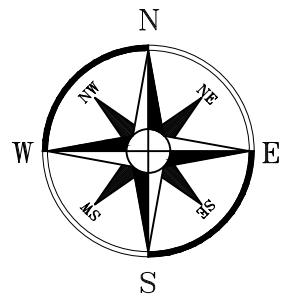
San Clemente in Rome			
A New Reconstruction of the Early 5th century Basilica and Its Origins			
<b>Series:</b>			
The surroundings of San Clemente			
<b>Description:</b> The archaeological evidence for the structures that were probably still in use at the beginning of the 5th century			
<b>Reference:</b> Lanciani Colini Guidobaldi	<b>Type:</b> Site plan	<b>Date:</b> 1.1.2010	<b>Scale:</b> 1:1500
<b>Copyright:</b> Juhana Heikonen Freesenkatu 3 A 10 00100 Helsinki Finland		<b>Drawing II</b>	





## LEGEND

-  Buildings
-  Agriculture (Vineyards)
-  Gardens



## San Clemente in Rome

A New Reconstruction of  
the Early 5th century Basilica and Its Origins

**Series:**

The surroundings of San Clemente

**Description:**

The digitized Giovanni Battista Nolli Map of 1748

**Reference:**  
Nolli

**Type:**

Site plan

**Date:**

1.1.2010

**Scale:**

1:1500

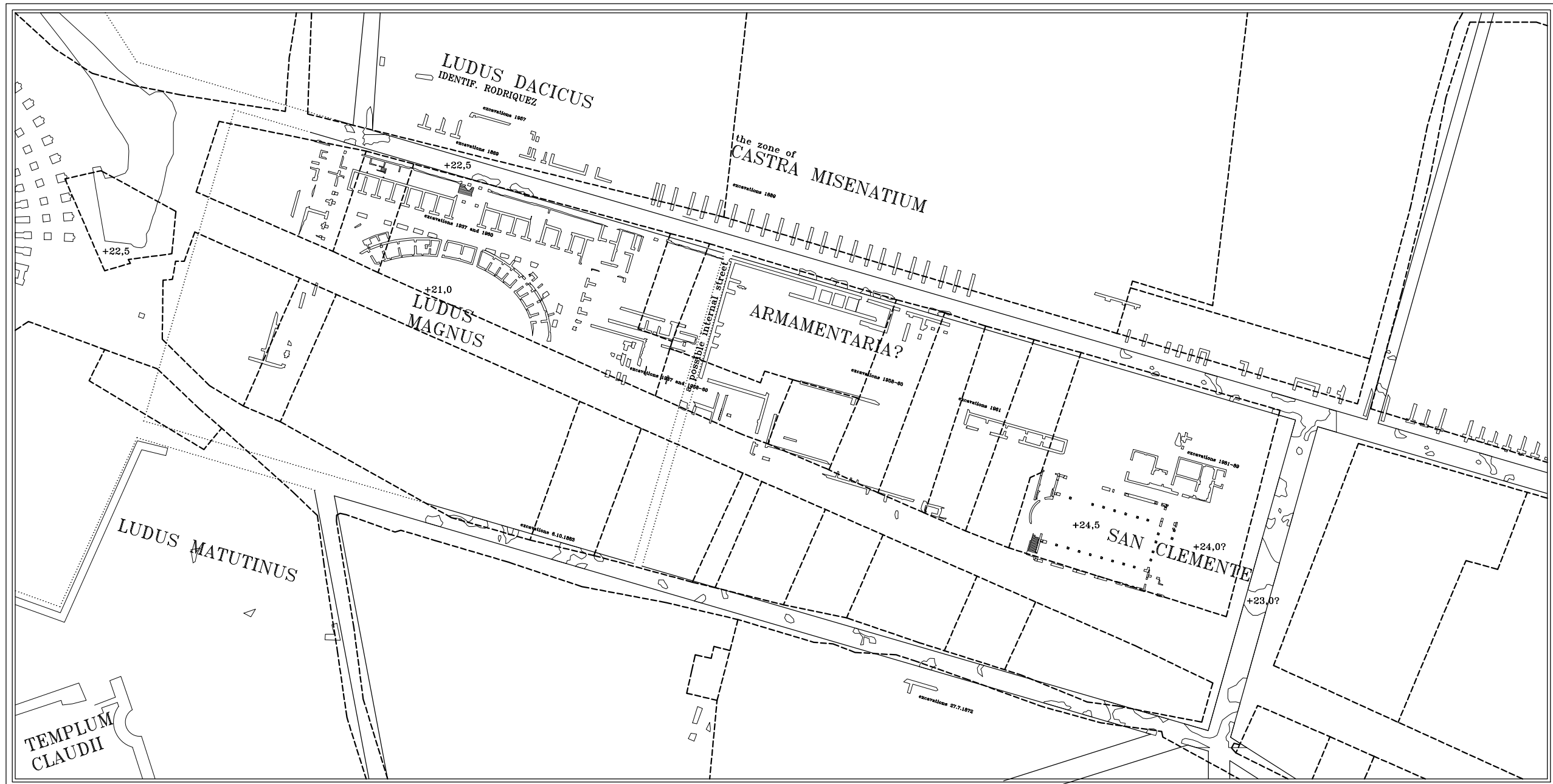
**Copyright:**

Juhana Heikonen  
Freesenkatu 3 A 10  
00100 Helsinki  
Finland

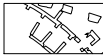

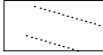

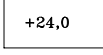
# Drawing III

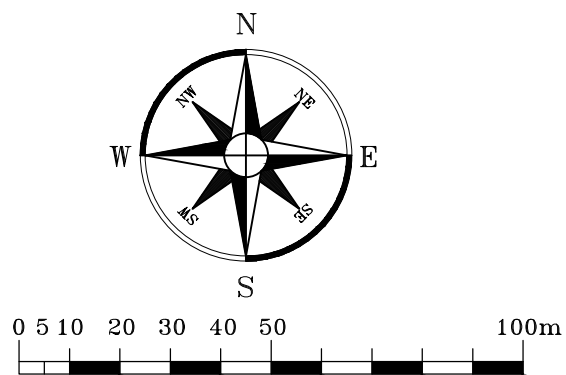






## LEGEND

-  Archaeological remains from ca. 400
-  The estate borders and streets according to Nolli
-  Hypothetical street lines
-  Archaeological evidence for paved streets
-  Altitude above sea level  
Tolerance 0.5m,  
?=hypothesis



## San Clemente in Rome

A New Reconstruction of  
the Early 5th century Basilica and Its Origins

Series:

The surroundings of San Clemente

Description:

The Nolli Map with additions

Reference:

Drawing II  
Drawing III

Type:

Site plan

Date:

1.1.2010

Scale:

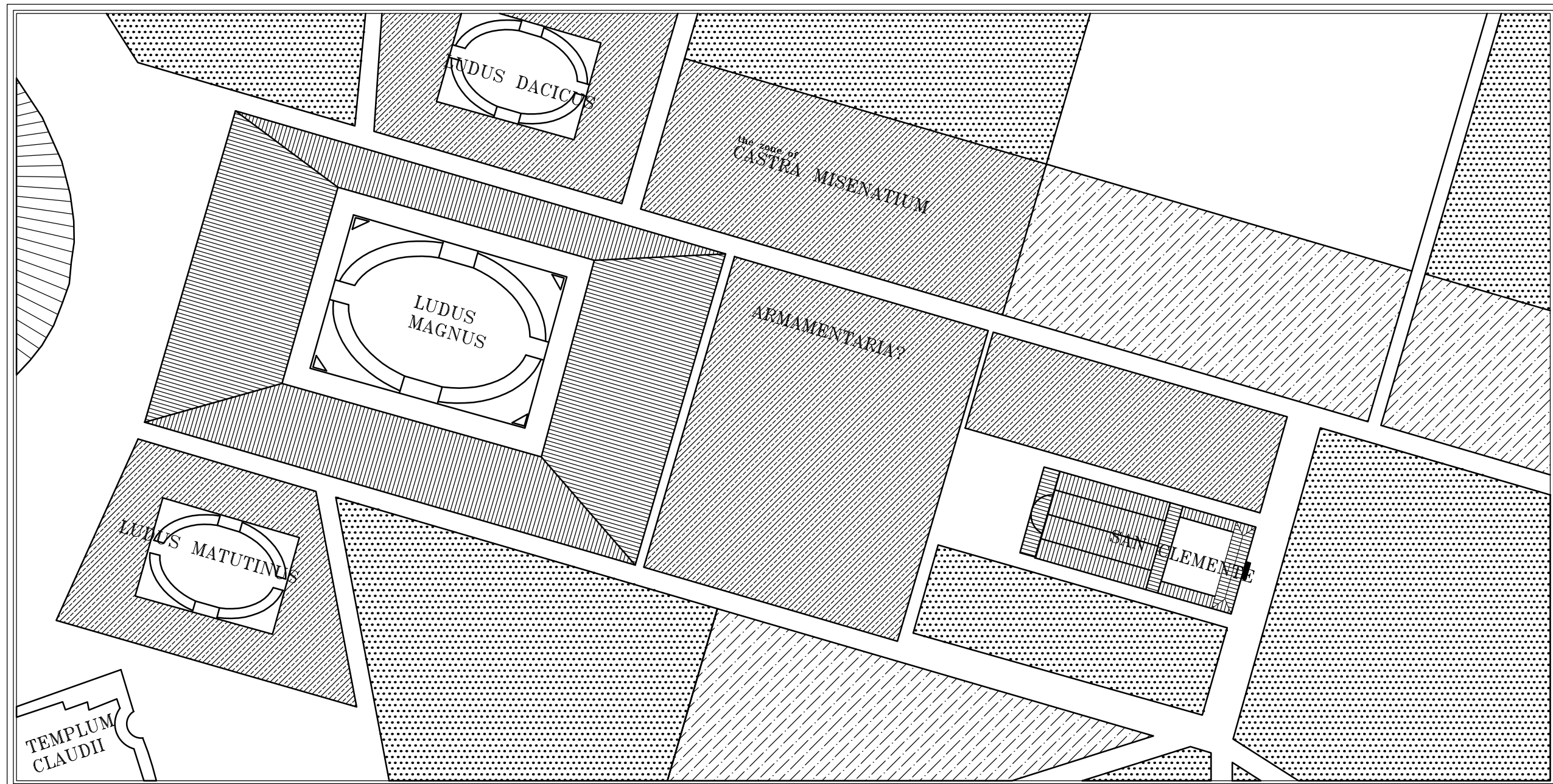
1:1500

Copyright:





Juhana Heikonen  
Freesenkatu 3 A 10  
00100 Helsinki  
Finland

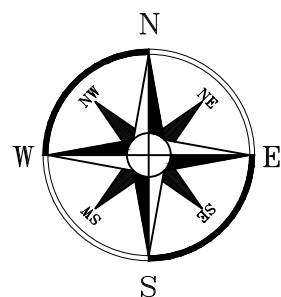
# Drawing IV





## LEGEND

-  <The form and function of the building is adequately known
-  <The function but not the form of the building is known
-  <There are remains of buildings but the form or function is unknown
-  <It is probable that there are remains of a building from the period



## San Clemente in Rome

A New Reconstruction of  
the Early 5th century Basilica and Its Origins

**Series:**

The surroundings of San Clemente

**Description:**

The reconstruction of the site plan of the early 5th century

**Reference:**

Lanciani  
Colini  
Guidobaldi

**Type:**

Site plan

**Date:**

1.1.2010

**Scale:**

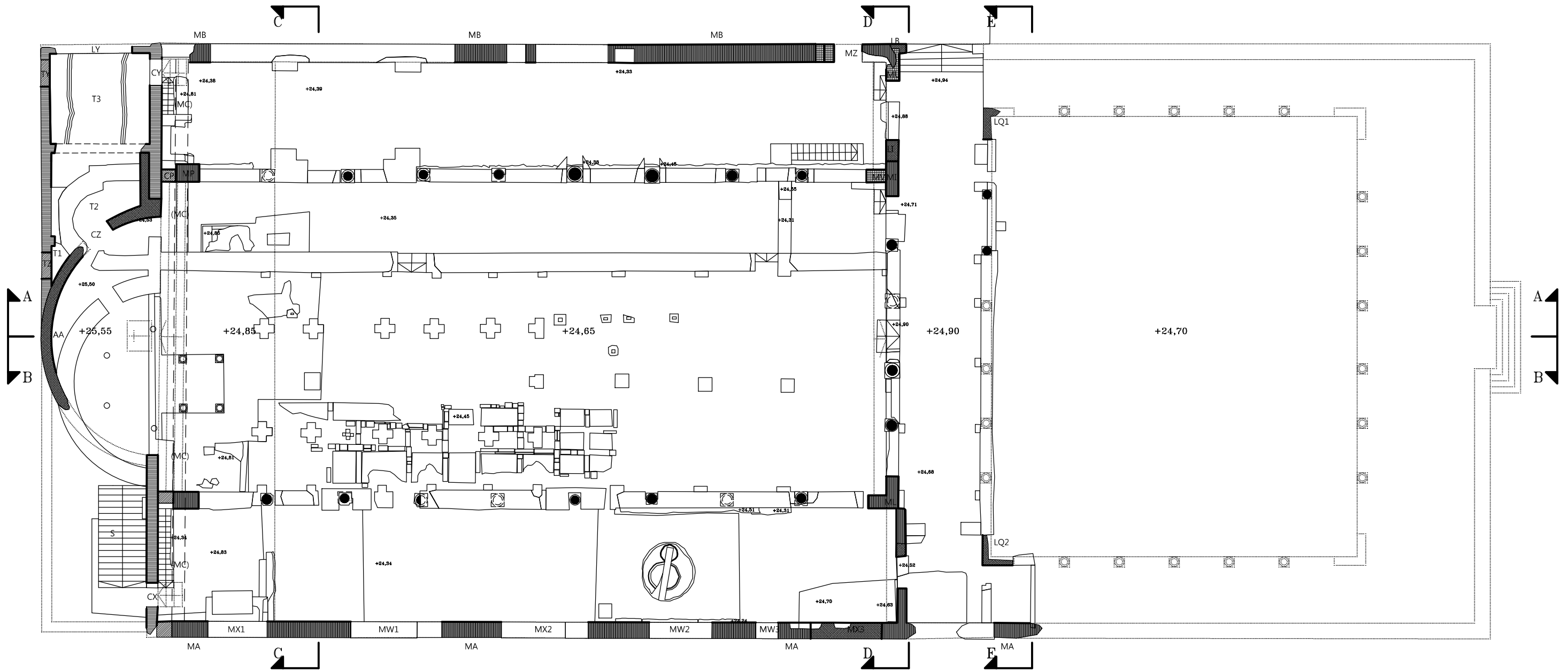
1:1500

**Copyright:**

Juhana Heikonen  
Freesenkatu 3 A 10  
00100 Helsinki  
Finland

Drawing V





**LEGEND**

- Opus Latericium 1st century
- Opus Latericium 3rd century
- Opus Latericium 4th century
- Opus Latericium 5th century
- Opus Listatum end of 4th century
- Other structures on the site, not used in the 5th century basilica
- Hypothesis of structures existing in the beginning of the 5th century
- Levels according to Guidobaldi 1992
- Hypothetical levels, beginning of the 5th century
- The archaeological data according to Guidobaldi 1992, Tav. V







<p><b>San Clemente in Rome</b>          A New Reconstruction of          the Early 5th century Basilica and Its Origins</p>			
<p><b>Series:</b>          The reconstructions of the basilica.</p>			
<p><b>Description:</b>          The reconstruction plans and sections</p>			
<p><b>Reference:</b>  <small>Guidobaldi 1992          Barclay-Lloyd 1989          CBCS I          Junyent 1932</small></p>	<p><b>Type:</b>          Plan</p>	<p><b>Date:</b>          1.1.2010</p>	<p><b>Scale:</b>          1:200</p>
<p><b>Copyright:</b>          Juhana Heikonen          Freesenkatu 3 A 10          00100 Helsinki          Finland</p>		<p><b>Drawing VI</b></p>	





SECTION A-A

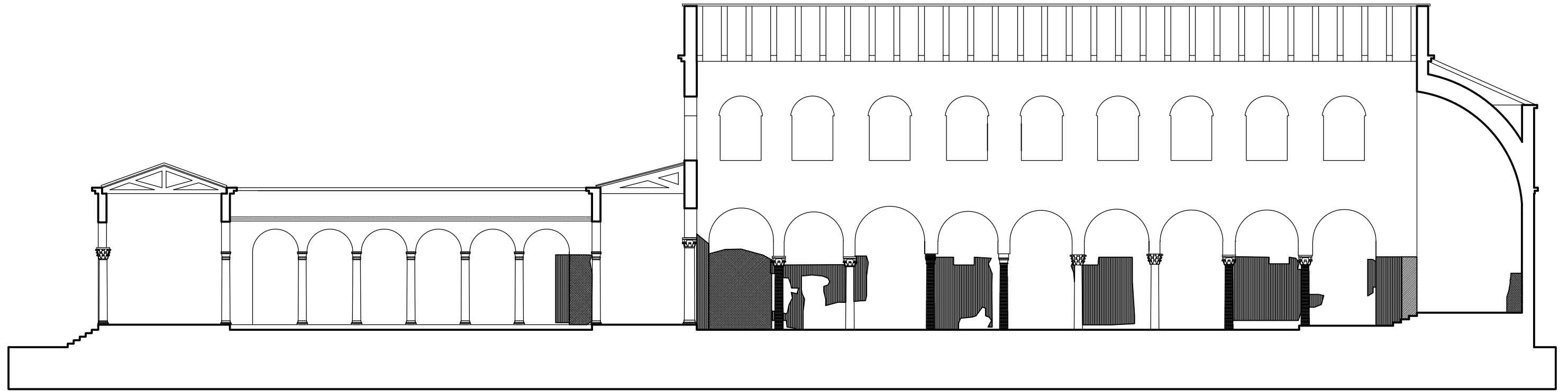
LEGEND

-  Opus Latericium 1st century
-  Opus Latericium 3rd century
-  Opus Latericium 4th century
-  Opus Latericium 5th century
-  Opus Listatum end of 4th century
-  The extant parts of columns

<p><b>San Clemente in Rome</b>          A New Reconstruction of          the Early 5th century Basilica and Its Origins</p>			
<p><b>Series:</b>          The reconstructions of the basilica.</p>			
<p><b>Description:</b>          The reconstruction plans and sections</p>			
<p><b>Reference:</b>  <small>Guidobaldi 1922          Barclay-Lloyd 1989          CRCS I          Junyent 1932</small></p>	<p><b>Type:</b>          Section</p>	<p><b>Date:</b>          1.1.2010</p>	<p><b>Scale:</b>          1:200</p>
<p><b>Copyright:</b>          Juhana Heikonen          Freesenkatu 3 A 10          00100 Helsinki          Finland</p>		<p><b>Drawing VIIa</b></p>	













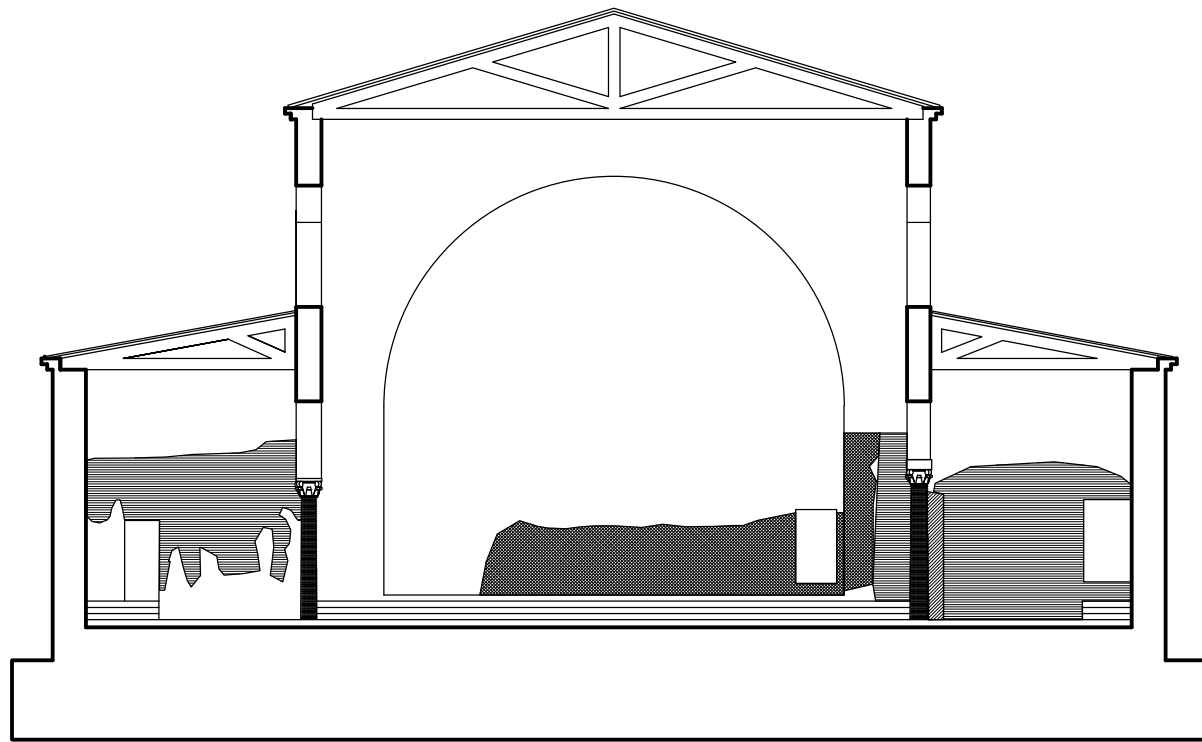
SECTION B-B

LEGEND

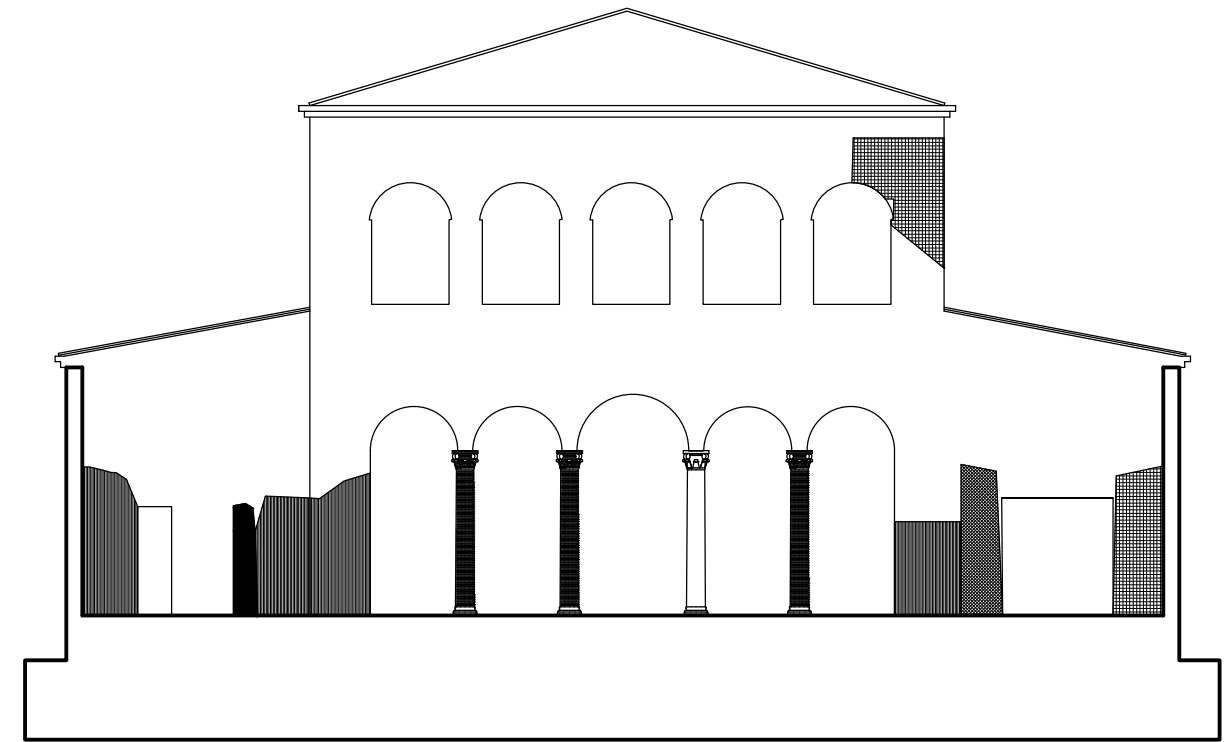
-  Opus Latericium 1st century
-  Opus Latericium 3rd century
-  Opus Latericium 4th century
-  Opus Latericium 5th century
-  Opus Listatum end of 4th century
-  The extant parts of columns

<p><b>San Clemente in Rome</b>          A New Reconstruction of          the Early 5th century Basilica and Its Origins</p>			
<p><b>Series:</b>          The reconstructions of the basilica.</p>			
<p><b>Description:</b>          The reconstruction plans and sections</p>			
<b>Reference:</b>	<b>Type:</b>	<b>Date:</b>	<b>Scale:</b>
<small>Gudobald 1906          Barclay-Lloyd 1909          CBCE I          August 1932</small>	Plan	1.1.2010	1:200
<p><b>Copyright:</b>                  Juhana Heikonen                  Freesenkatu 3 A 10                  00100 Helsinki                  Finland</p>		<b>Drawing VIIb</b>	











SECTION C-C



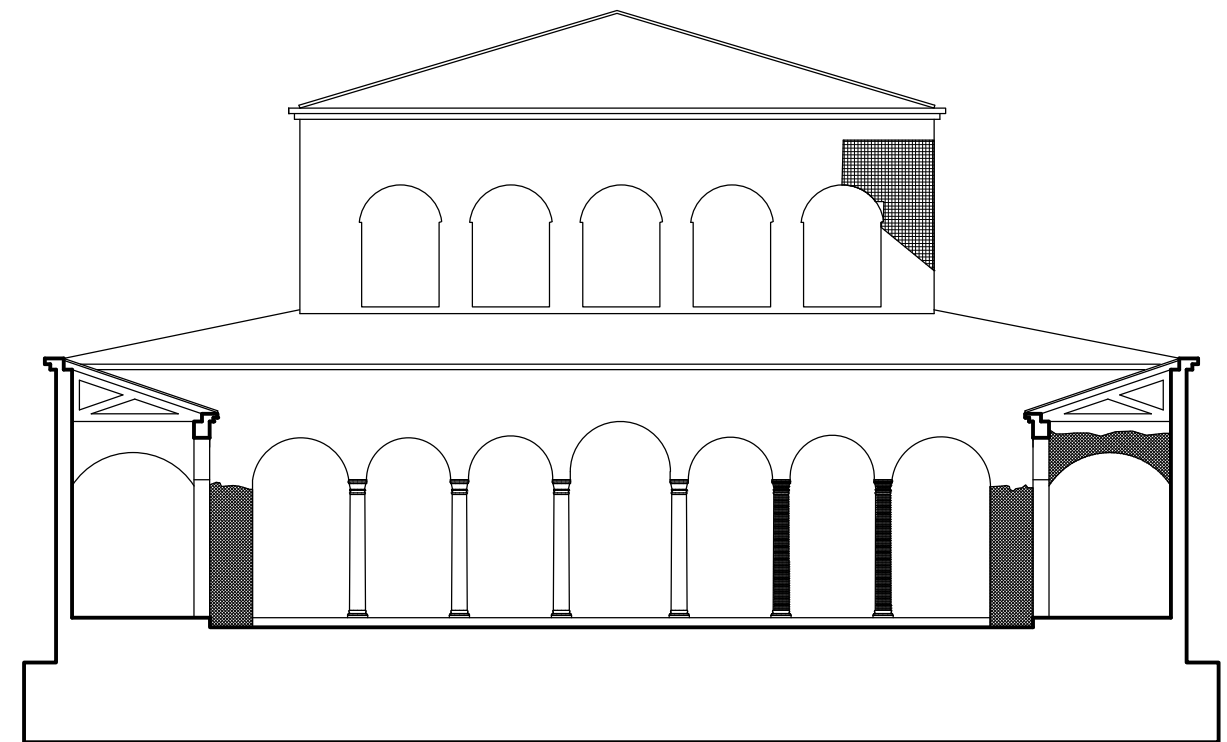
SECTION D-D

LEGEND

-  Opus Latericium 1st century
-  Opus Latericium 3rd century
-  Opus Latericium 4th century
-  Opus Latericium 5th century
-  Opus Listatum end of 4th century
-  The extant parts of columns







<p><b>San Clemente in Rome</b>          A New Reconstruction of          the Early 5th century Basilica and Its Origins</p>			
<p><b>Series:</b>          The reconstructions of the basilica.</p>			
<p><b>Description:</b>          The reconstruction plans and sections</p>			
<p><b>Reference:</b>  <small>Guidobaldi 1992          Barclay-Lloyd 1989          CERS I          Junzent 1932</small></p>	<p><b>Type:</b>          Plan</p>	<p><b>Date:</b>          1.1.2010</p>	<p><b>Scale:</b>          1:200</p>
<p><b>Copyright:</b>          Juhana Heikonen          Freesenkatu 3 A 10          00100 Helsinki          Finland</p>		<p><b>Drawing VIIC</b></p>	





SECTION E-E

## LEGEND

	Opus Latericium 1st century
	Opus Latericium 3rd century
	Opus Latericium 4th century
	Opus Latericium 5th century
	Opus Listatum end of 4th century
	The extant parts of columns

## San Clemente in Rome

A New Reconstruction of  
the Early 5th century Basilica and Its Origins

### Series:

The reconstructions of the basilica.

### Description:

The reconstruction plans and sections

### Reference:

Guidobaldi 1992  
Barclay-Lloyd 1989  
CSCS I  
Junyent 1932

### Type:

Plan

### Date:

1.1.2010

### Scale:

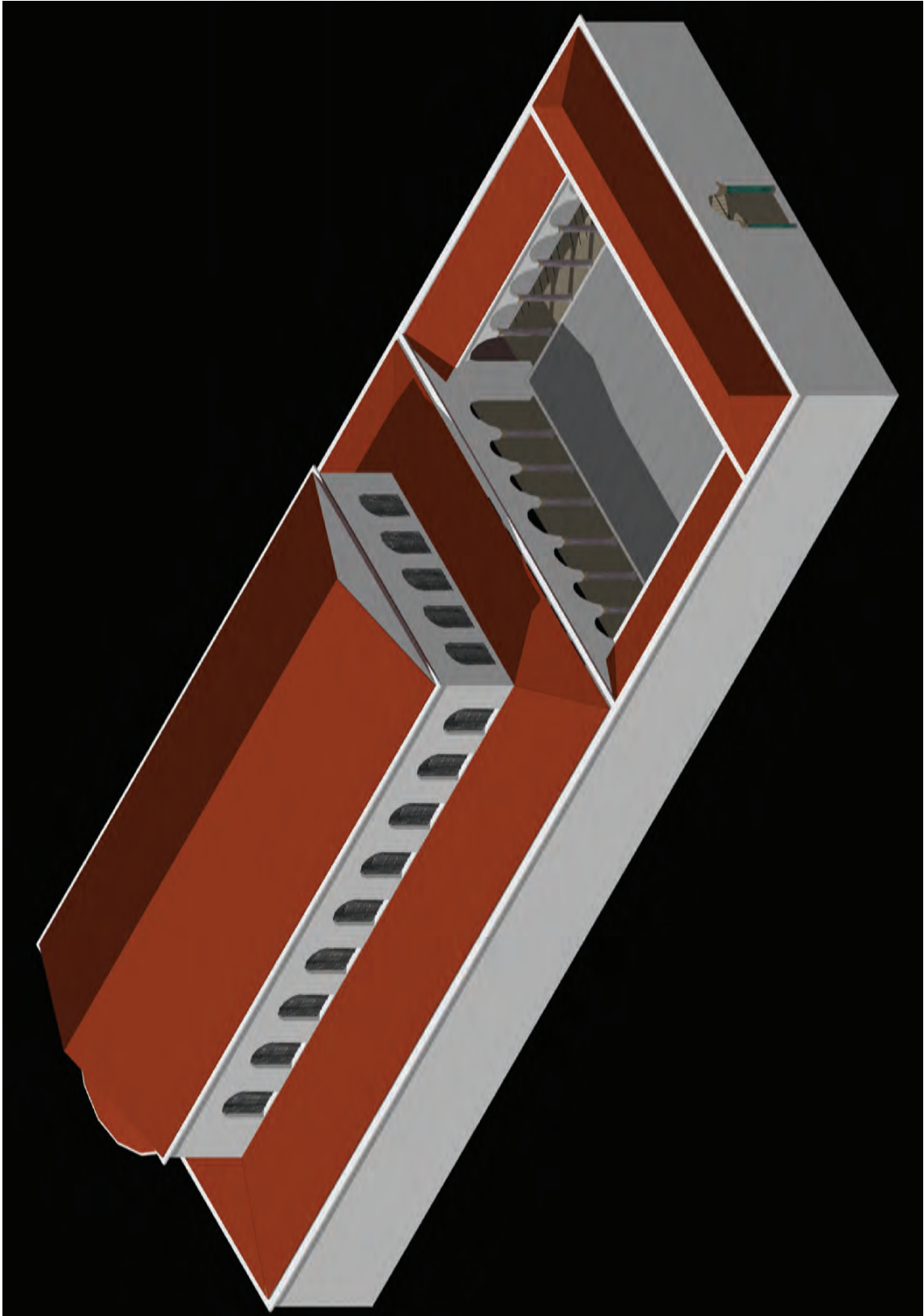
1:200

### Copyright:

Juhana Heikonen  
Freesenkatu 3 A 10  
00100 Helsinki  
Finland

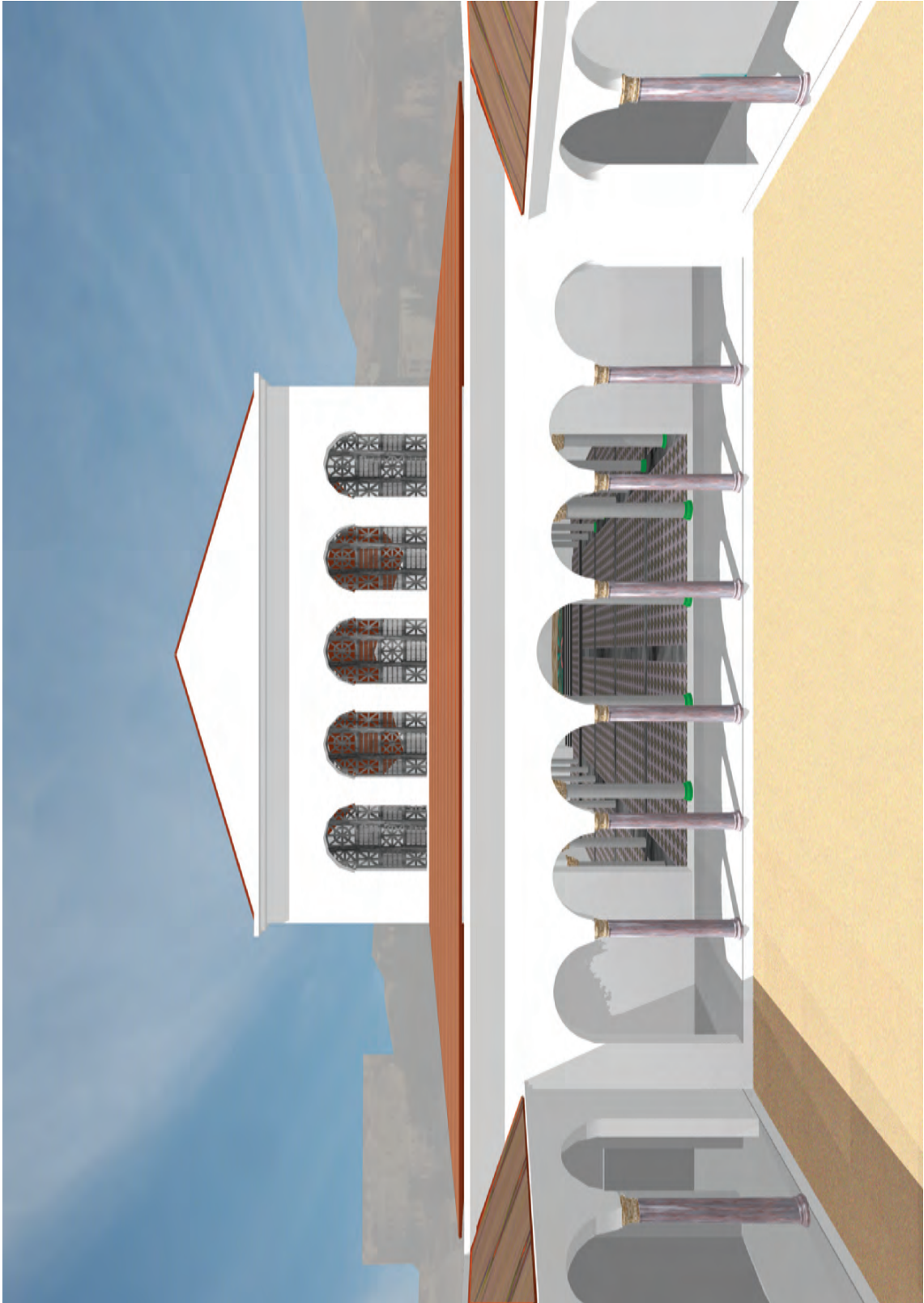
**Drawing VIId**





Drawing VIII, Axonometric view of the 3D reconstruction model, perspective.

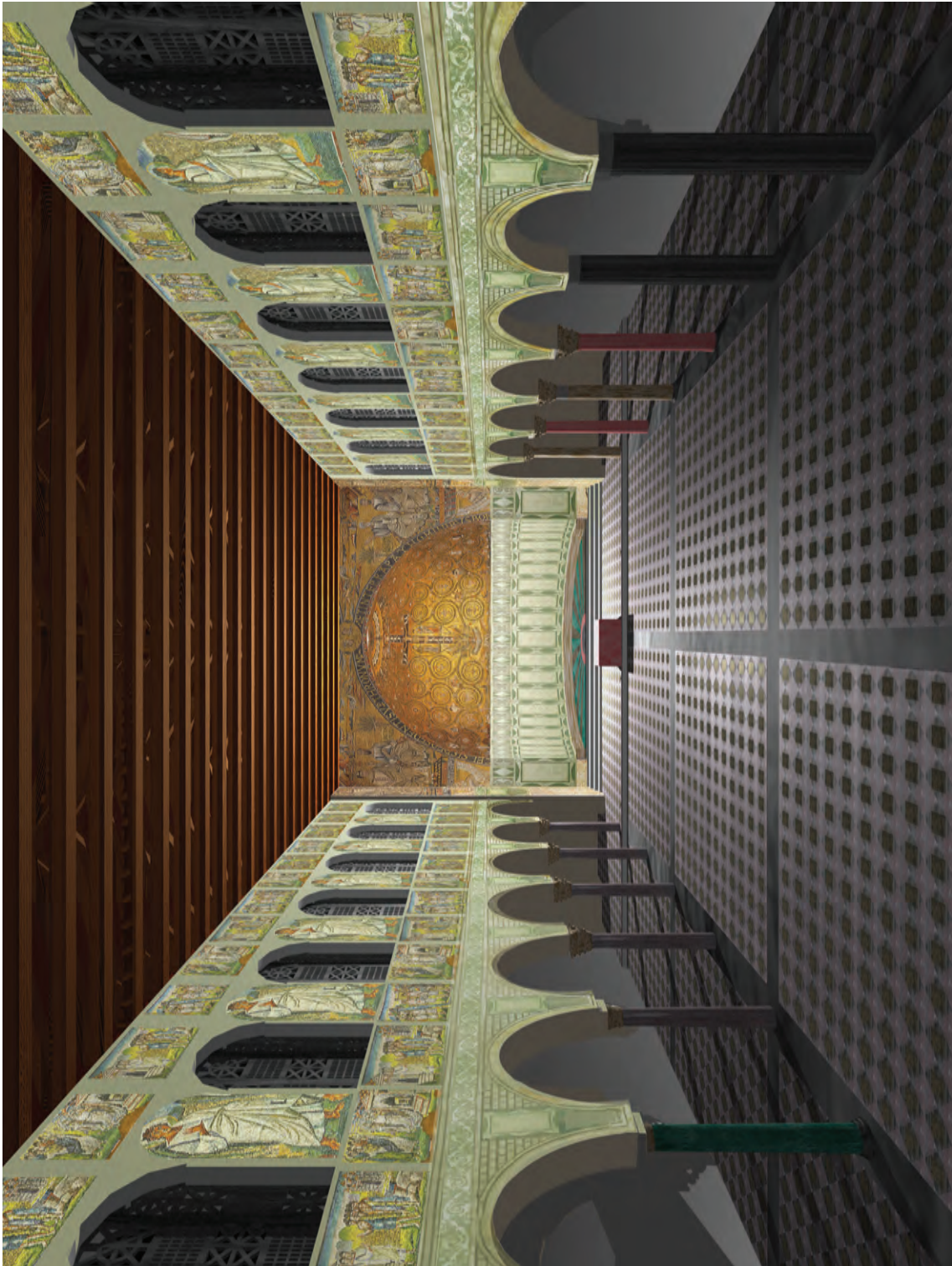




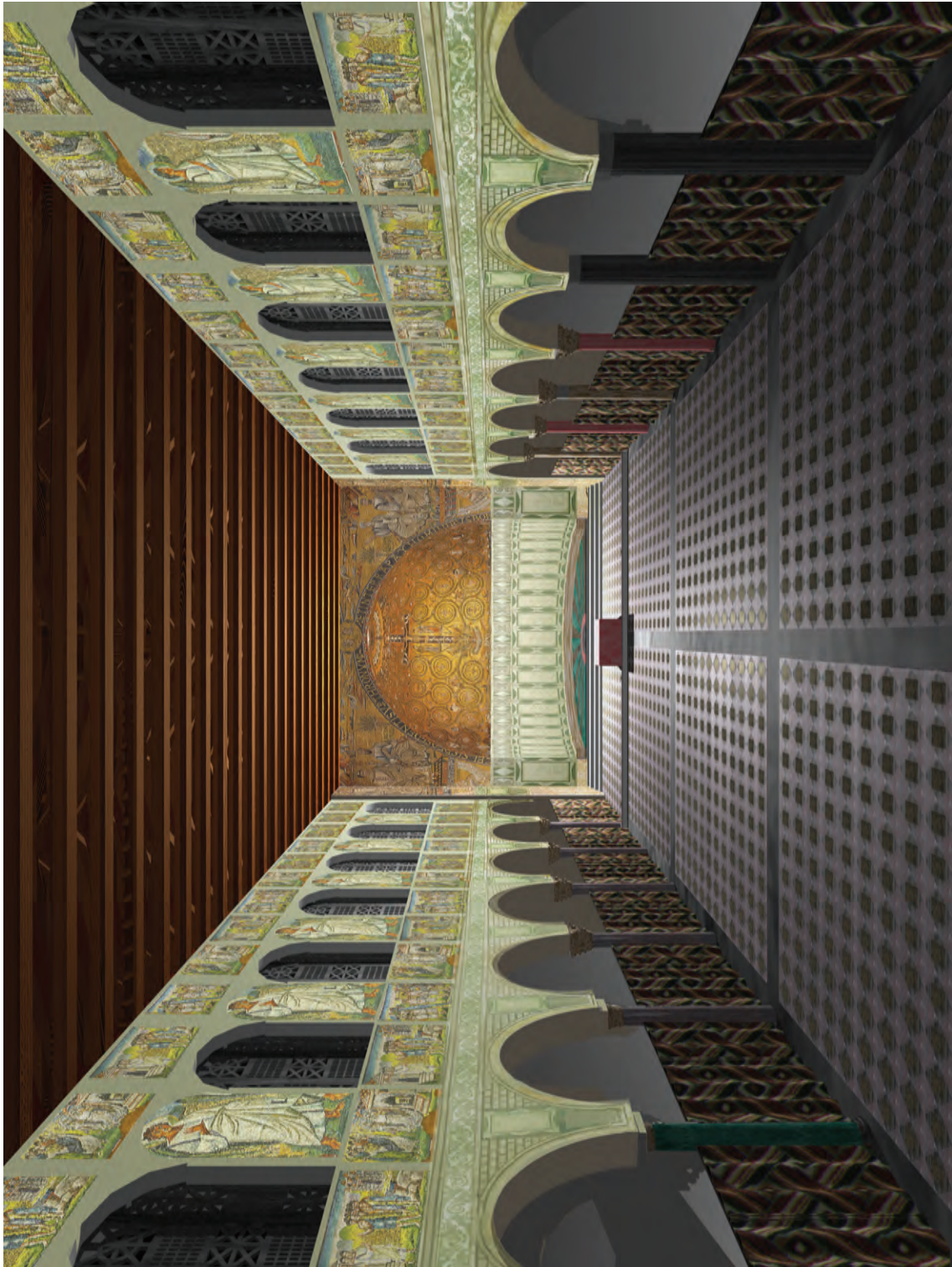
Drawing IX, A view from the atrium from the 3D reconstruction model, perspective.



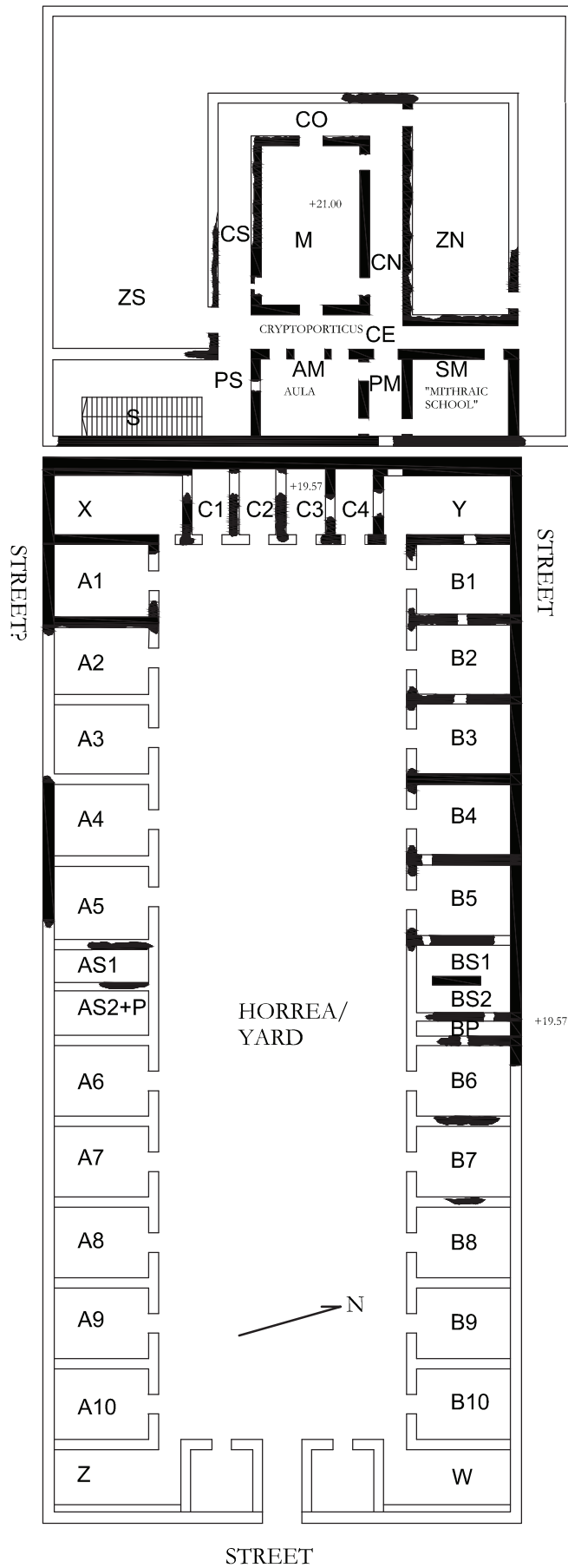
Drawing Xa, A view from the nave to the apse from the 3D reconstruction model, perspective.



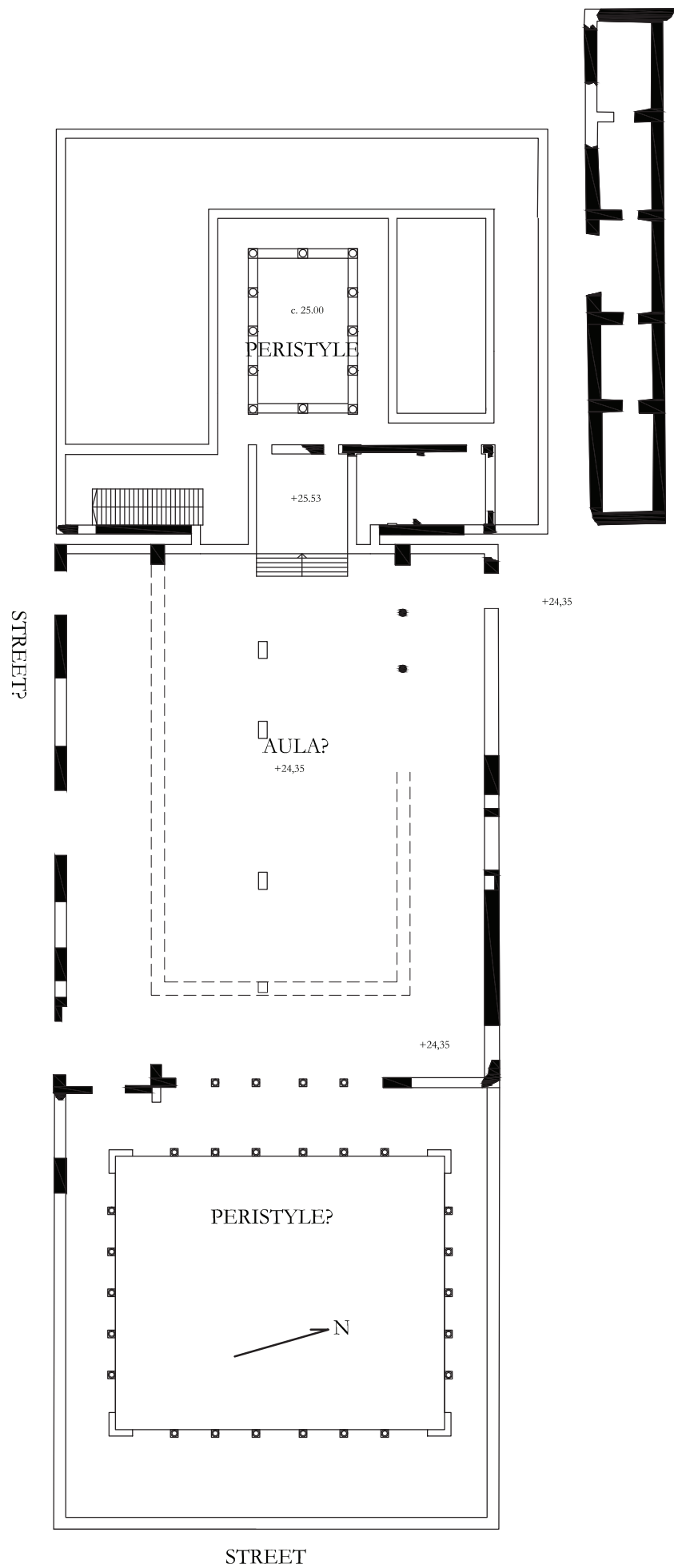
Drawing Xb, A view from the nave to the apse from the 3D reconstruction model, perspective.



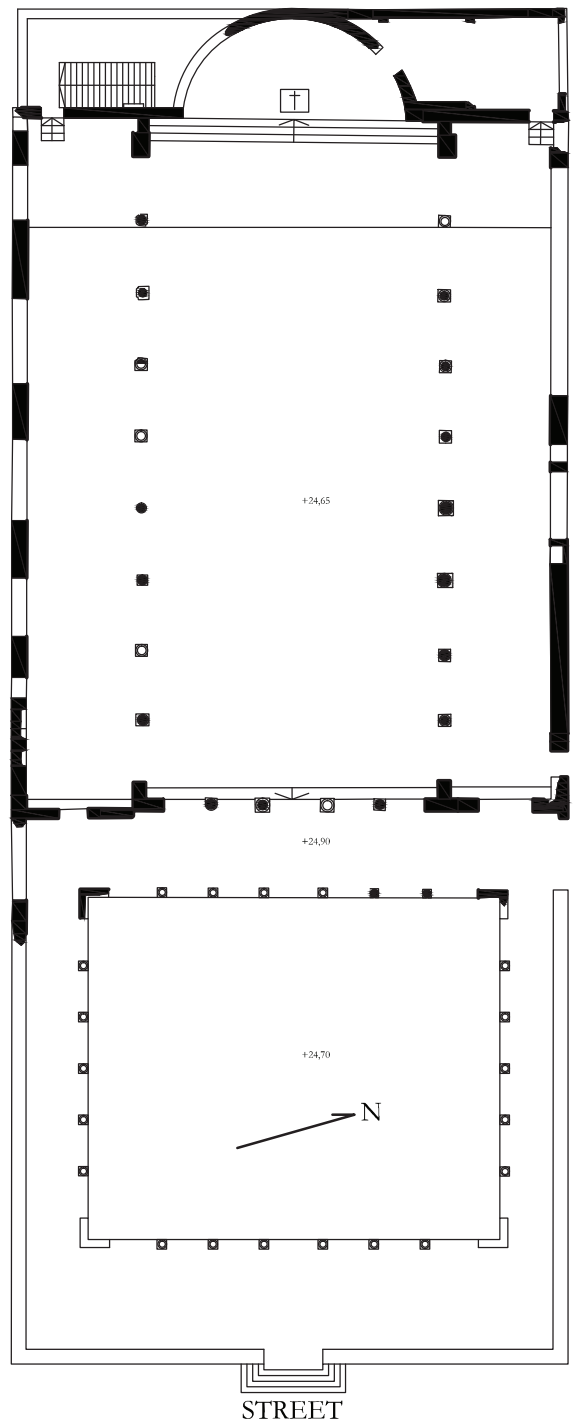
Drawing Xc, A view from the nave to the apse from the 3D reconstruction model, perspective.



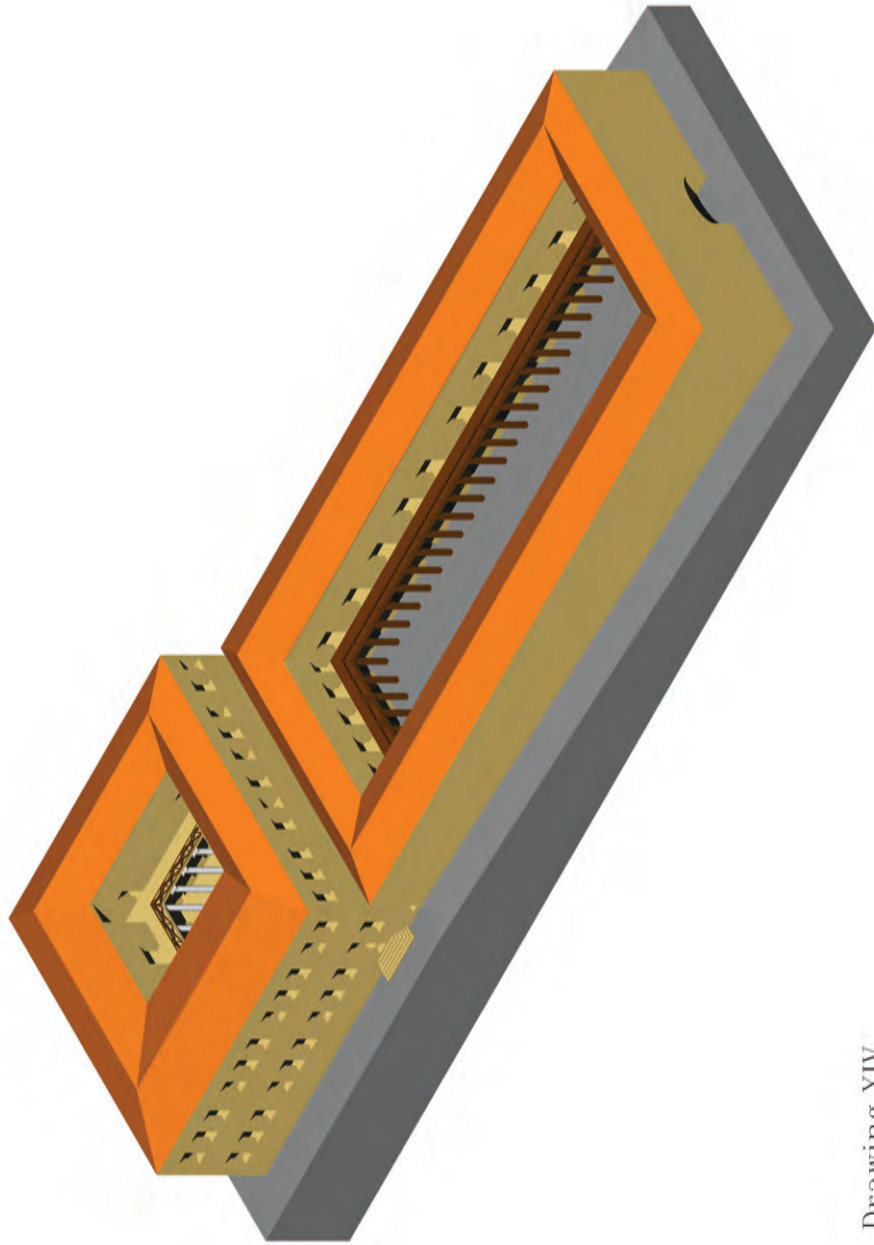
Drawing XI, Phase II, The *domus* and *horrea* at the end of first century. Scale 1:400. Based on Guidobaldi 1992, Tav. I, IV, V, XVI, XVII; CBCR (San Clemente); Junyent 1932.



Drawing XII, Phase IVb, The second level of the first *domus* and the added ground floor of the possible second *domus* in the third century as joined together. Scale 1:400. Based on Guidobaldi 1992, Tav. I, IV, V, XVI, XVII; CBCR (San Clemente); Junyent 1932.



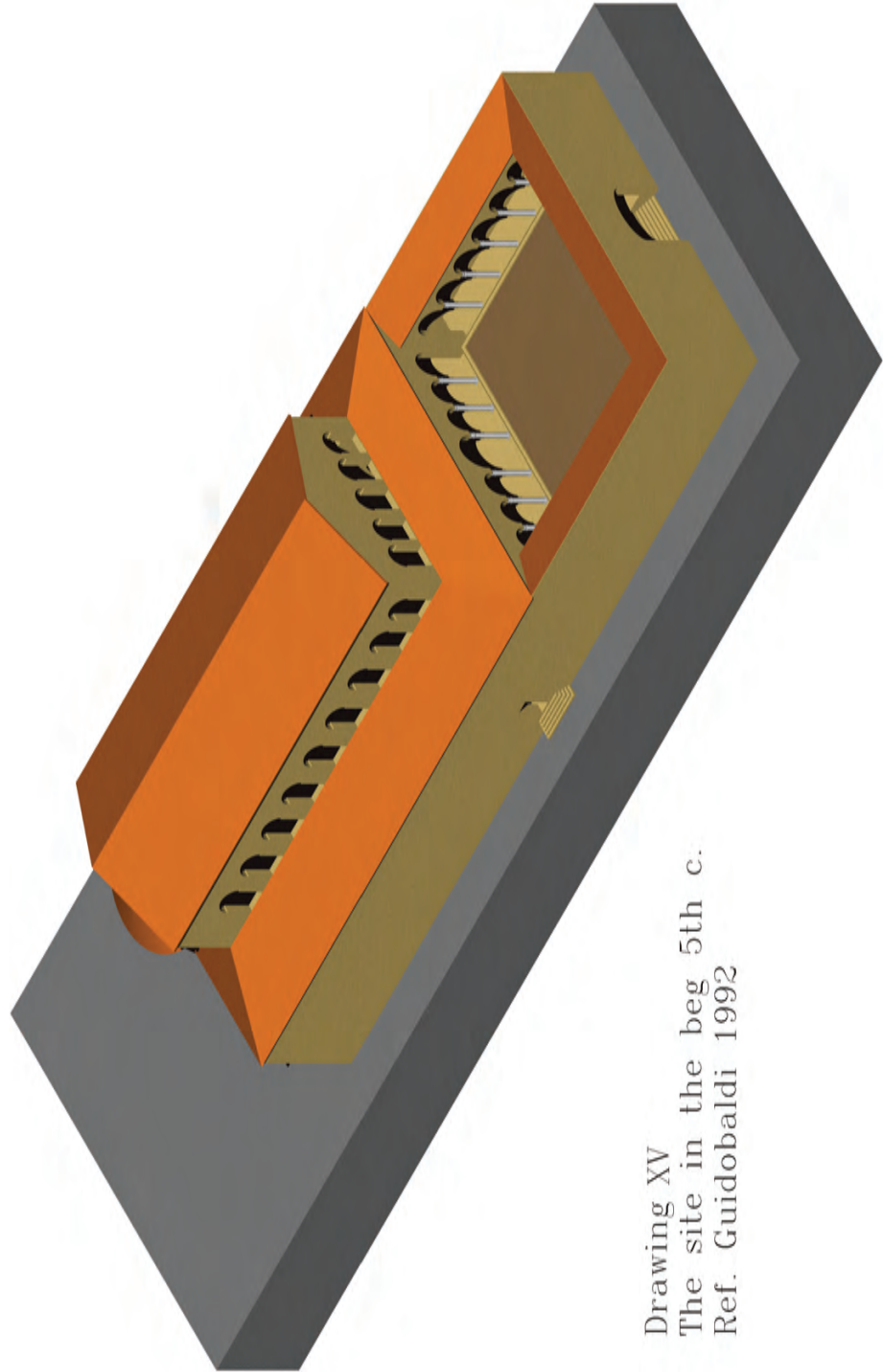
Drawing XIII, Phase V, San Clemente, end of fourth century or beginning of fifth century. Scale 1:400. Based on Guidobaldi 1992, Tav. I, IV, V, XVI, XVII; CBCR (San Clemente); Junyent 1932.



Drawing XIV  
The site in the 1st century

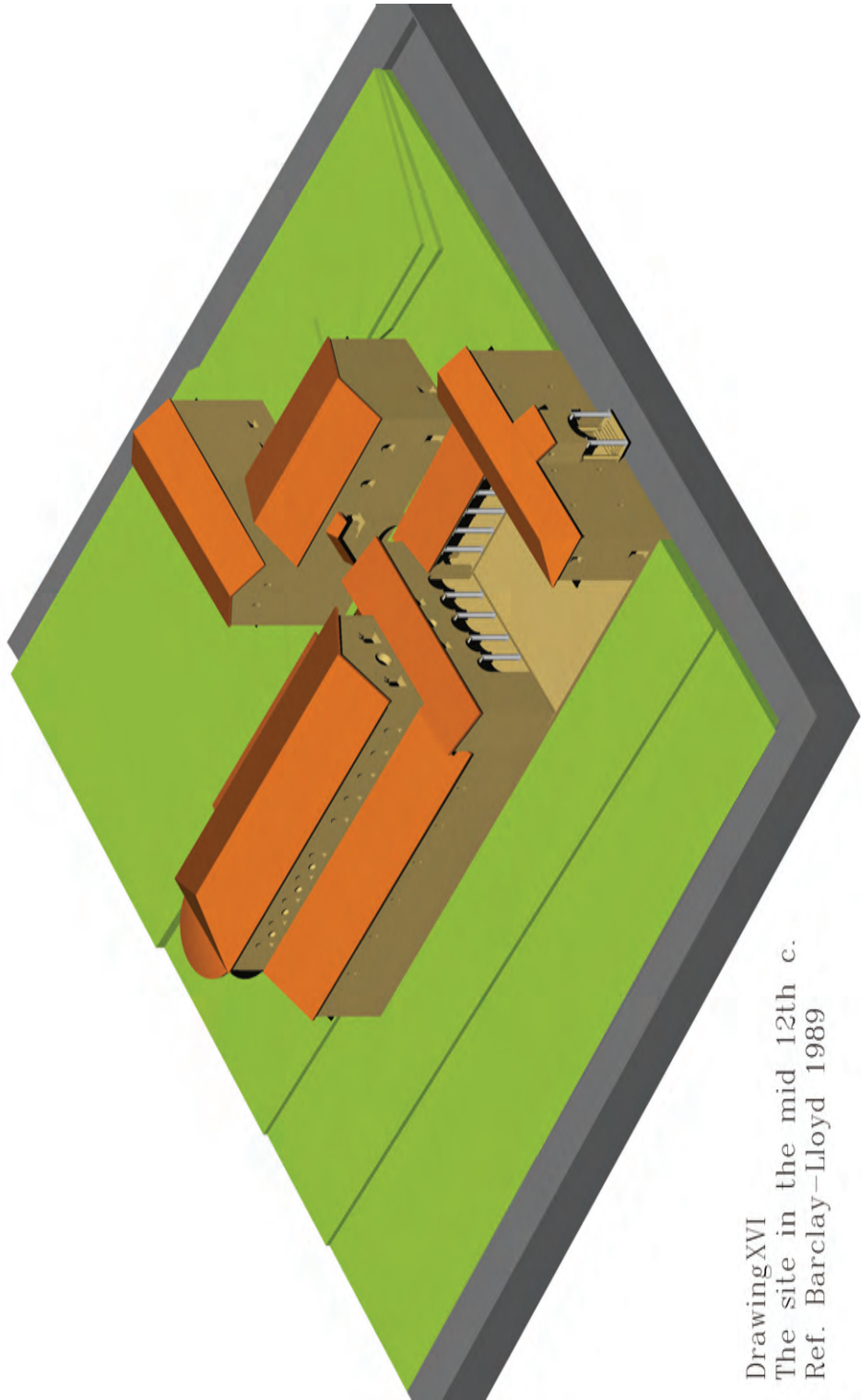
Drawing XIV, The site ca. 100.





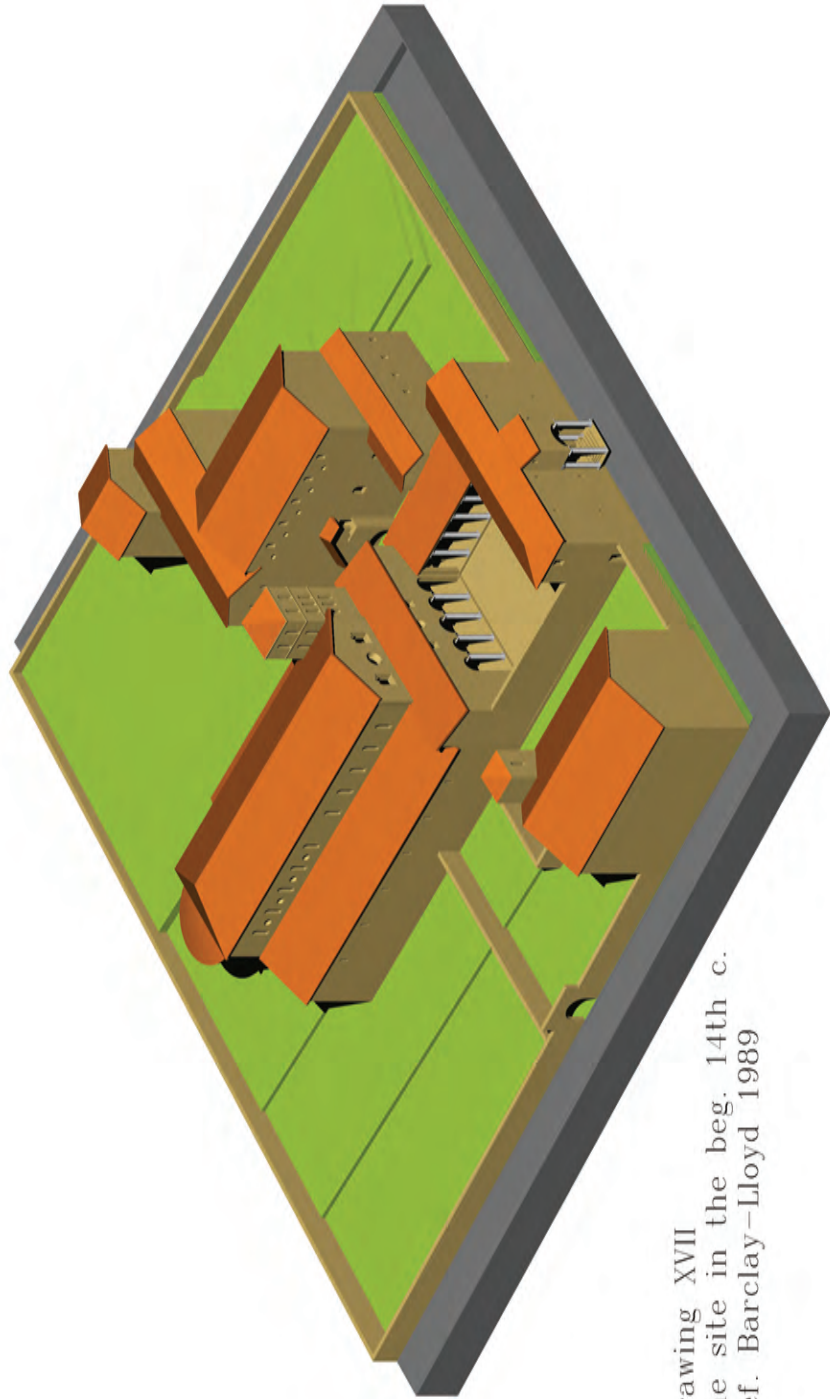
Drawing XV  
The site in the beg 5th c.  
Ref. Guidobaldi 1992

Drawing XV, The site ca. 400.



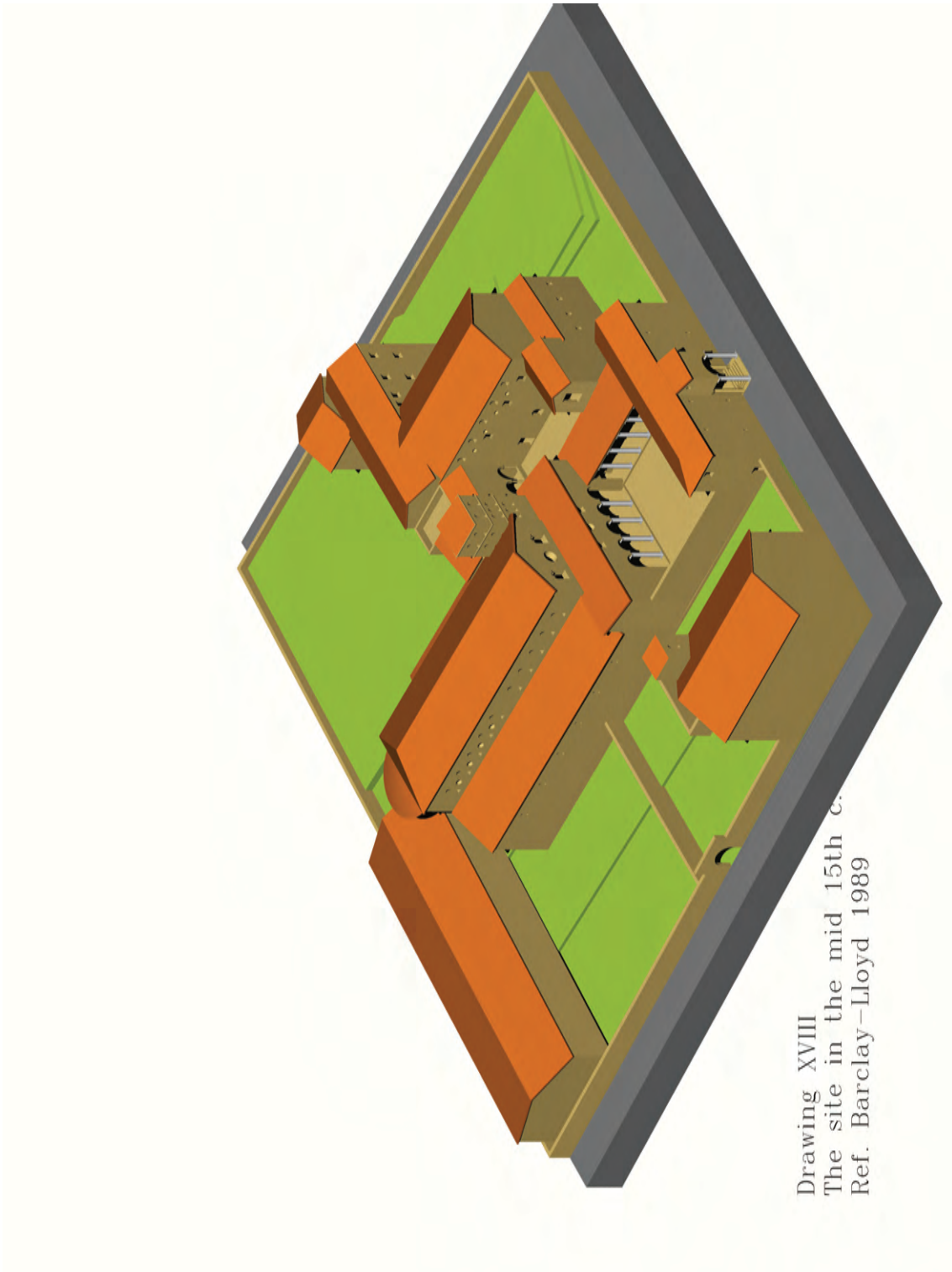
Drawing XVI  
The site in the mid 12th c.  
Ref. Barclay-Lloyd 1989

Drawing XVI, The site ca. 1150.



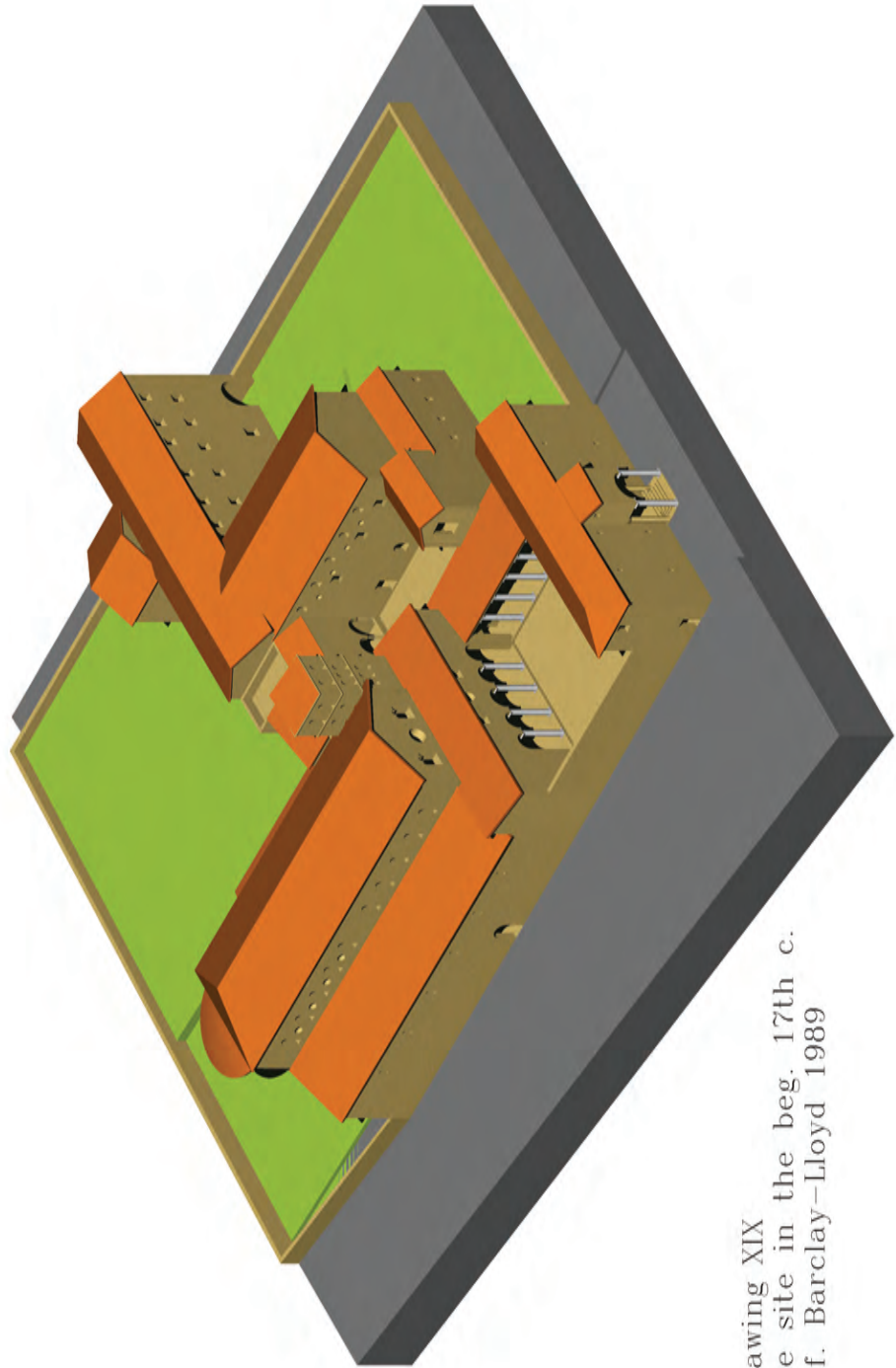
Drawing XVII  
The site in the beg. 14th c.  
Ref. Barclay-Lloyd 1989

Drawing XVII, The site ca. 1300.



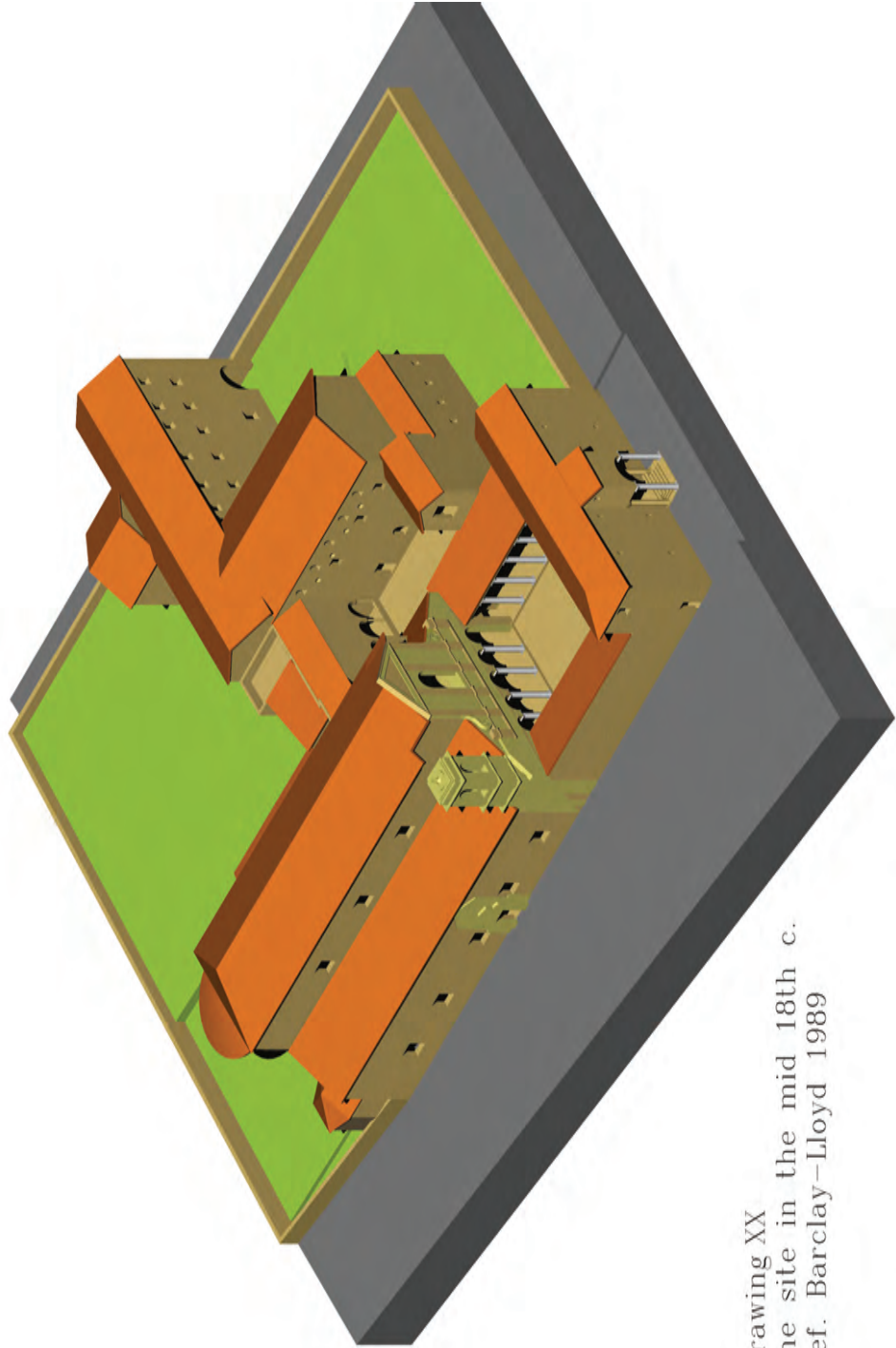
Drawing XVIII  
The site in the mid 15th c.  
Ref. Barclay-Lloyd 1989

Drawing XVIII, The site ca. 1450.



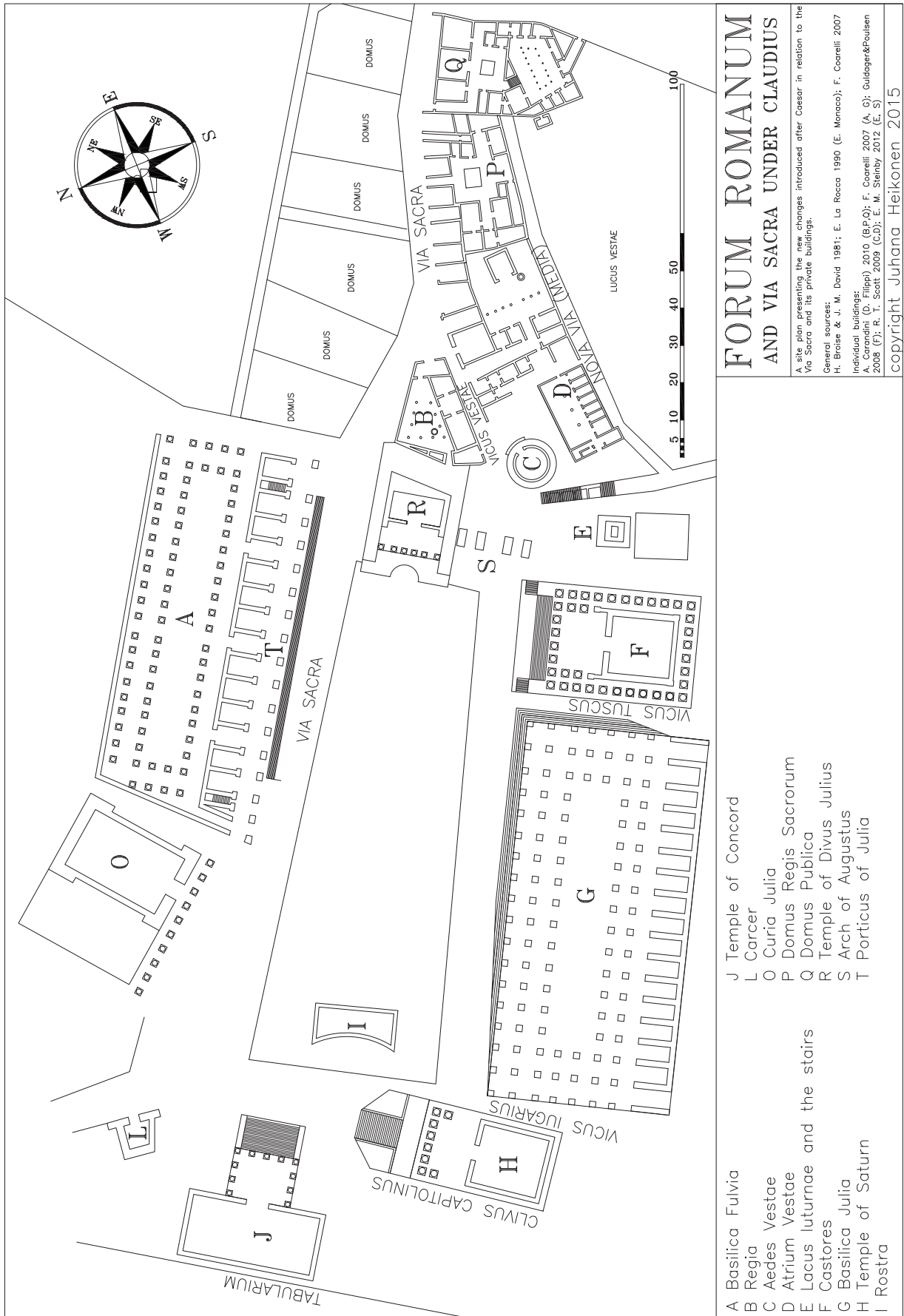
Drawing XIX  
The site in the beg. 17th c.  
Ref. Barclay-Lloyd 1989

Drawing XIX, The site ca. 1600.



Drawing XX  
The site in the mid 18th c.  
Ref. Barclay-Lloyd 1989

Drawing XX, The site ca. 1750.



# FORUM ROMANUM AND VIA SACRA UNDER CLAUDIUS

A site plan presenting the new changes introduced after Caesar in relation to the Via Sacra and its private buildings.

General sources:  
H. Bröese & J. M. David 1961; E. La Rocca 1990 (E. Monaco), F. Coarelli 2007

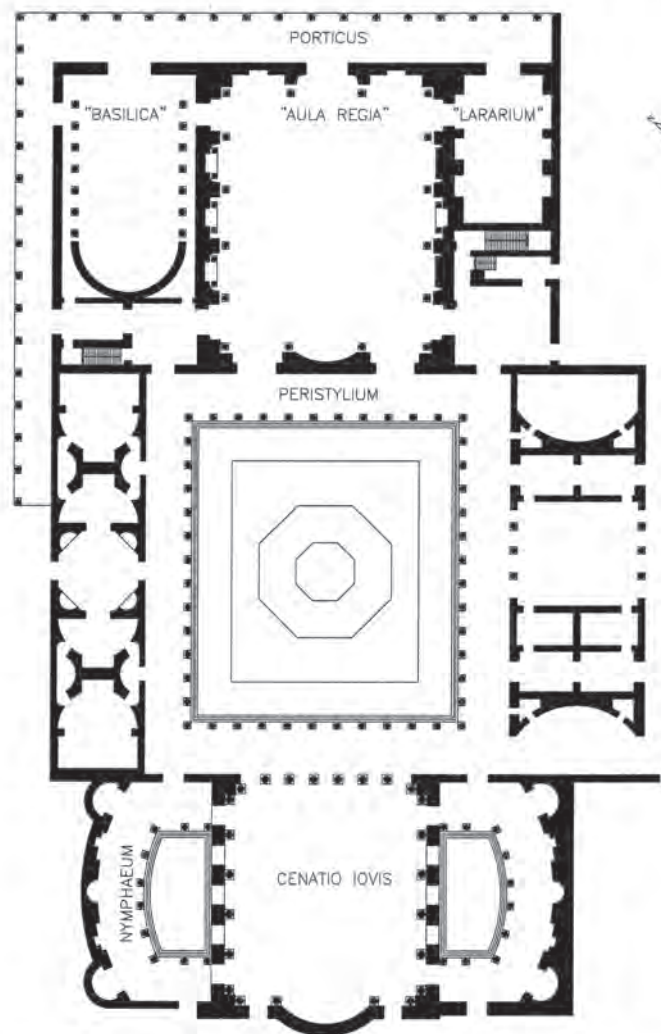
Individual buildings:  
A. Carandini (D. Filippi) 2010 (B.P.O.); F. Coarelli 2007 (A. G); Guidagreg&Poulsen 2008 (P); R. T. Scott 2009 (C.D); E. M. Steinby 2012 (E. S)

copyright Juhana Heikonen 2015

- A Basilica Fulvia
- B Regia
- C Aedes Vestae
- D Atrium Vestae
- E Lacus Iuturnae and the stairs
- F Castores
- G Basilica Julia
- H Temple of Saturn
- I Rostra
- J Tabularium
- L Curia Julia
- O Temple of Concord
- P Domus Regis Sacrorum
- Q Domus Publica
- R Temple of Divus Julius
- S Arch of Augustus
- T Porticus of Julia

Drawing XXI  
Forum Romanum 1:1500, Claudian Period  
The secular basilica's open relation to the Forum.

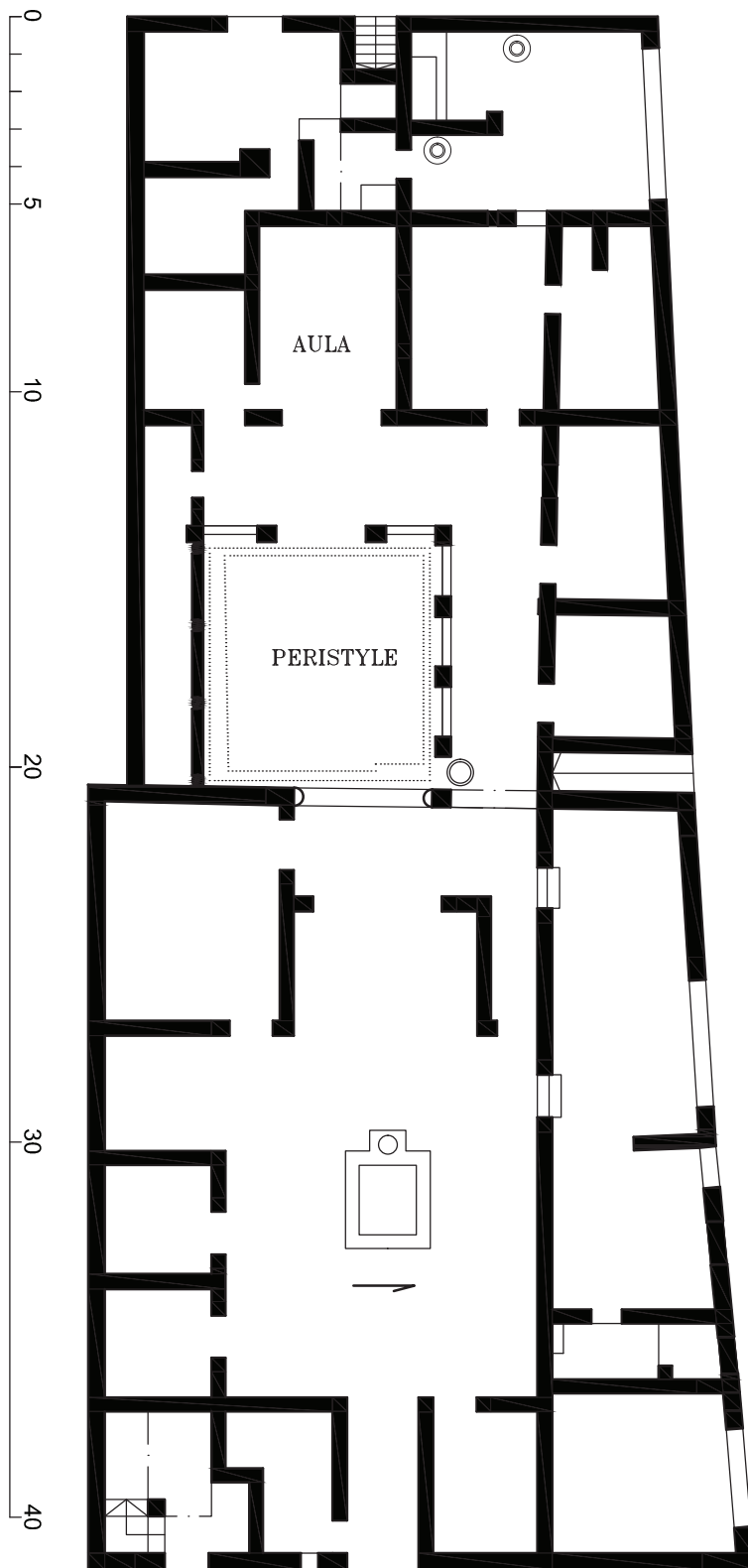
DOMUS FLAVIA      DOMUS AUG.



Domus Flavia. 1:1000. Juhana Heikonen

Drawing XXII.

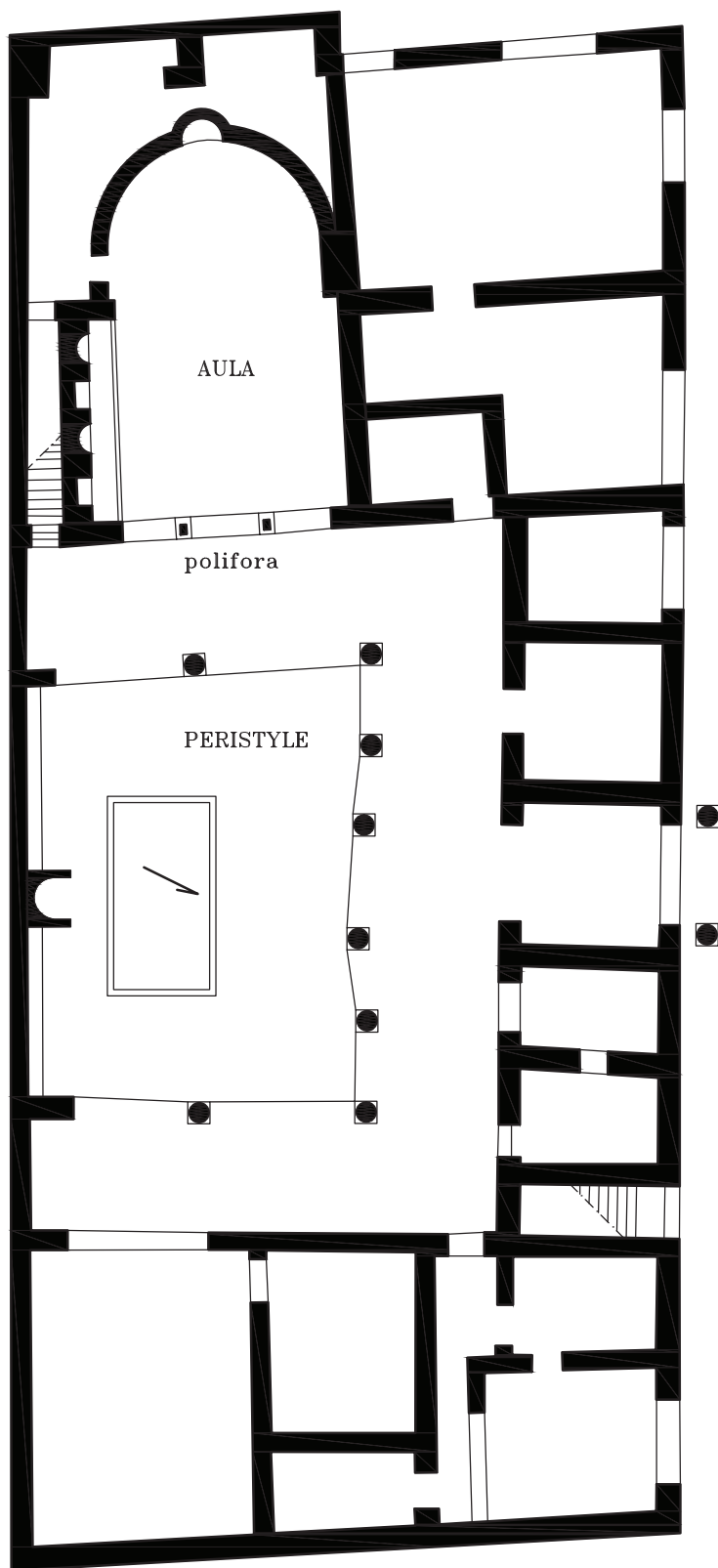




D. XXIII, Casa del Tramezzo di Legno,  
Herculaneum

1:200

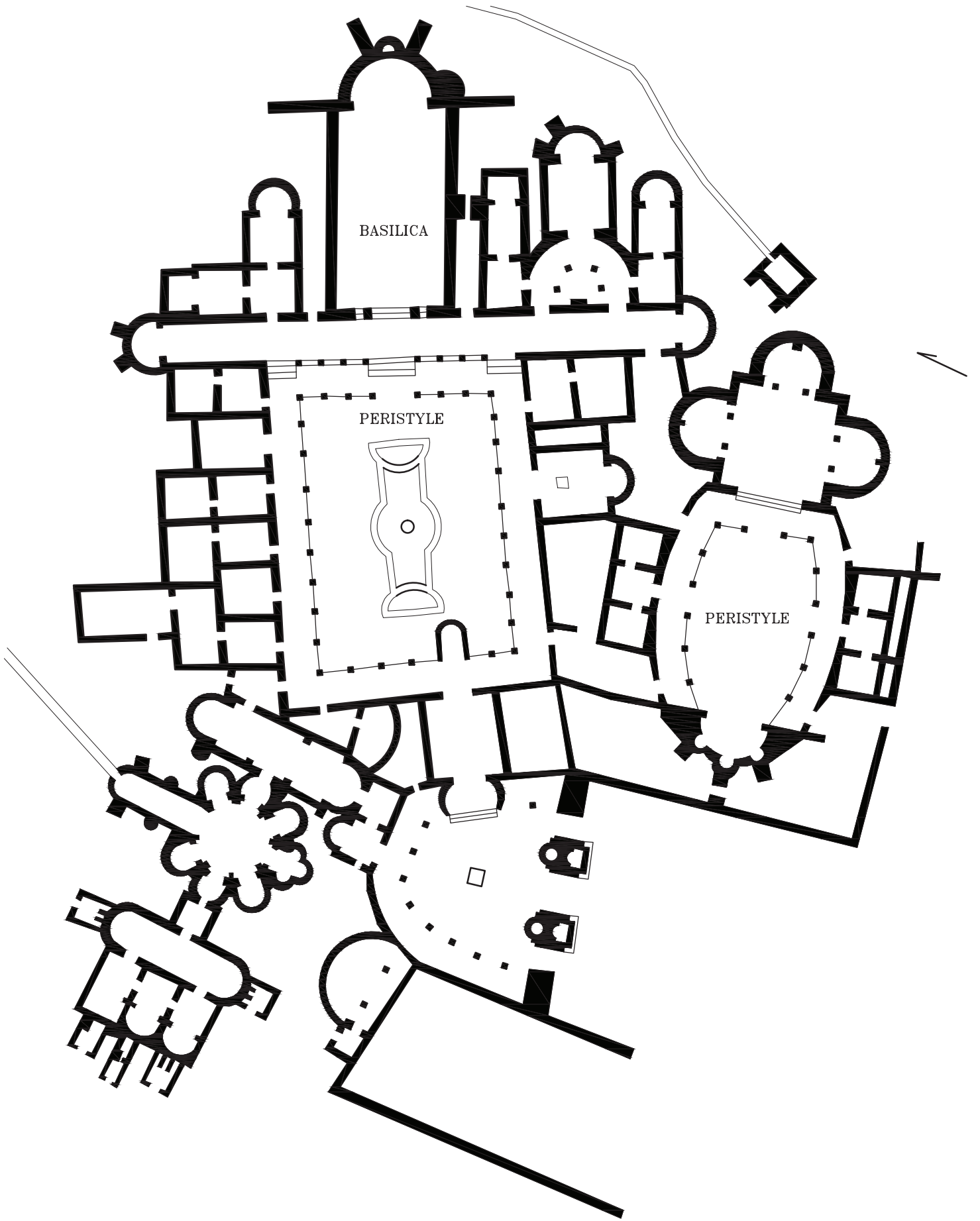
Public and Private in the Roman House -project (PPRH)  
J. Heikonen 2014



D. XXIV, Domus della Fortuna Annonanria,  
Ostia, Regio V,II,8

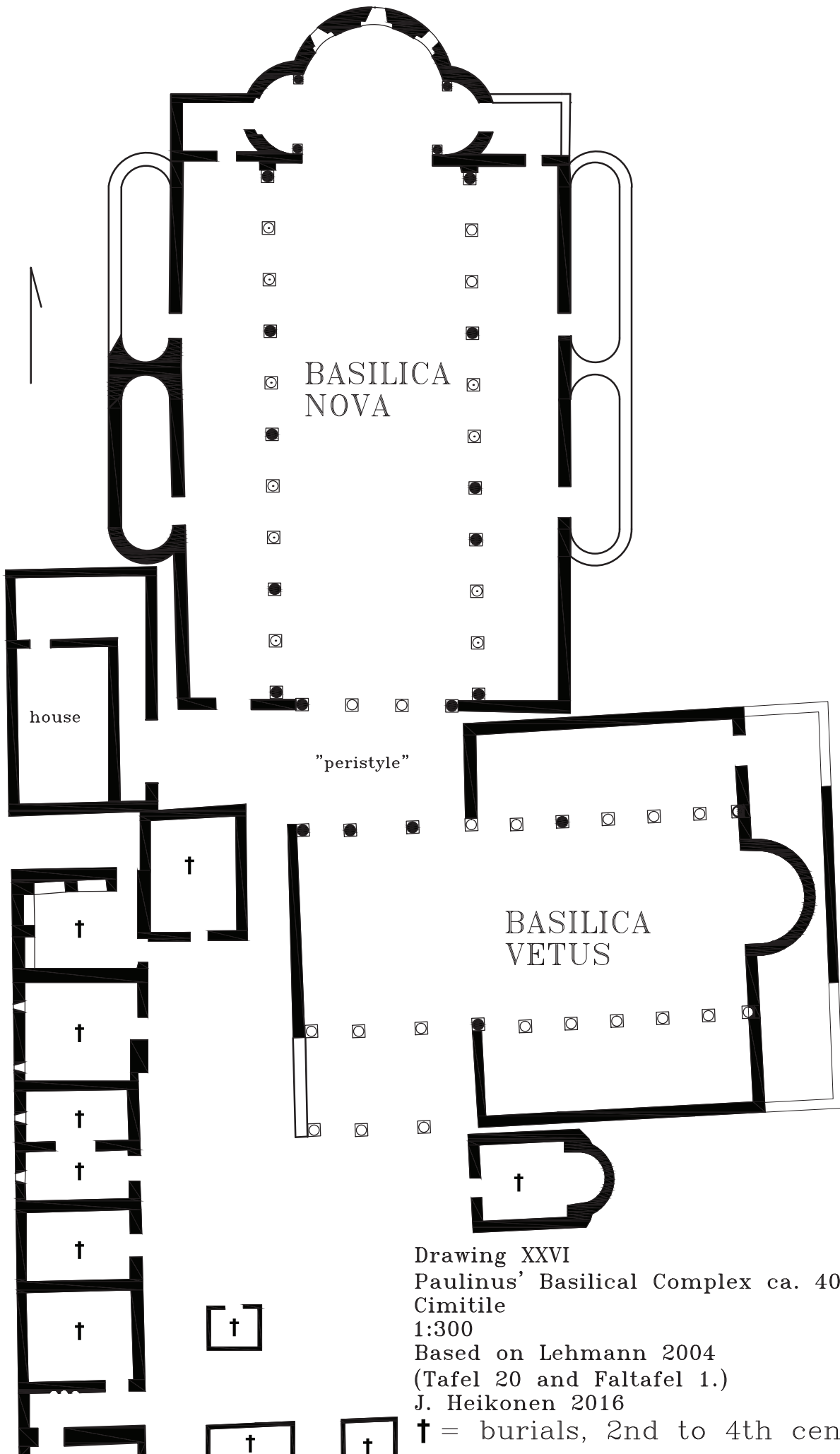
Situation during the second half of the 4th century  
1:200

Based on Becatti 1948 (Fig. 23) and Heres 1982 (Fig. 97)  
J. Heikonen 2016



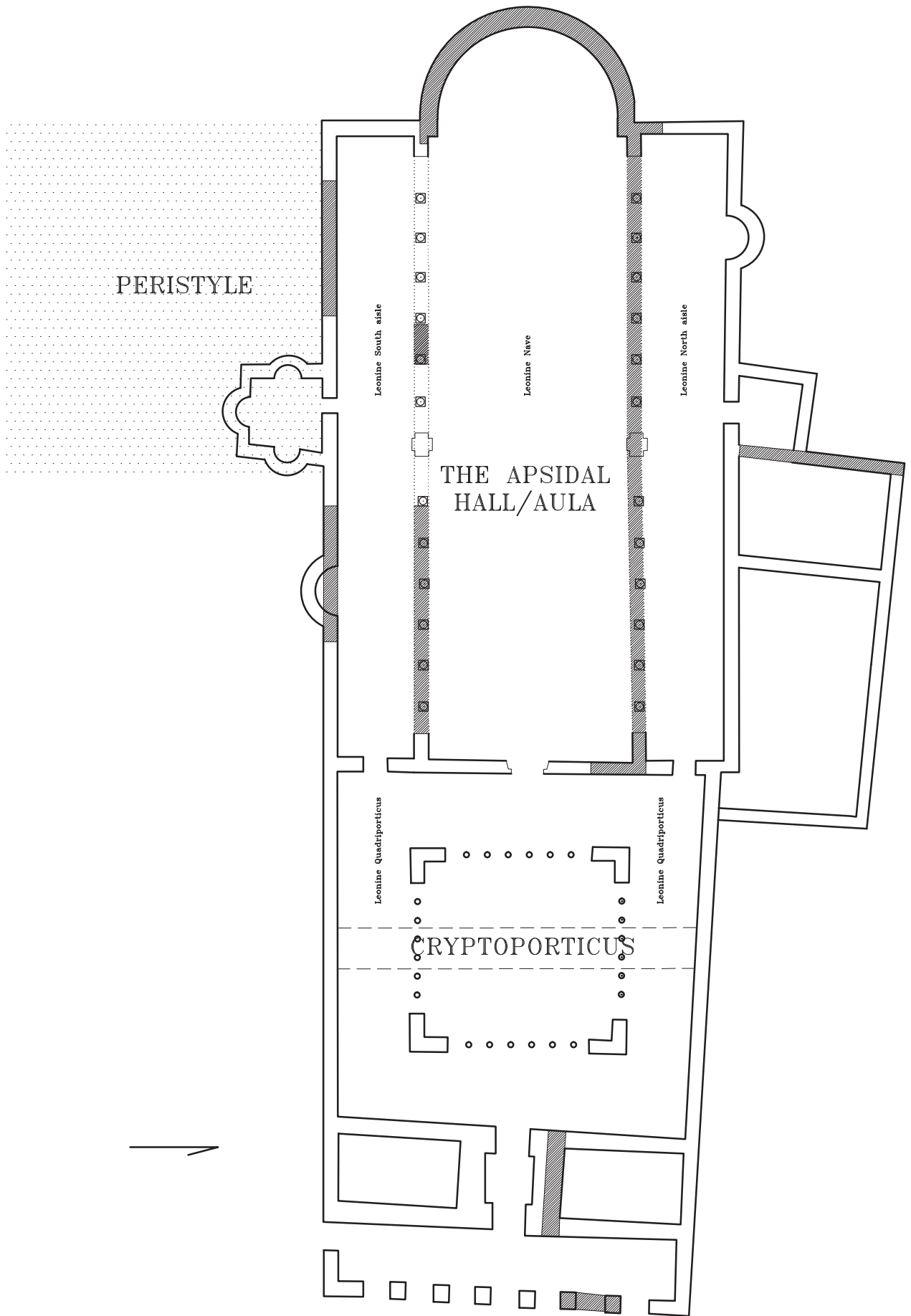
D. XXV, Villa Romana del Piazza Armerina, Sicily

1:600  
Based on A. Carandini 1982  
J. Heikonen 2016



Drawing XXVI  
 Paulinus' Basilical Complex ca. 400  
 Cimitile  
 1:300  
 Based on Lehmann 2004  
 (Tafel 20 and Faltafel 1.)  
 J. Heikonen 2016

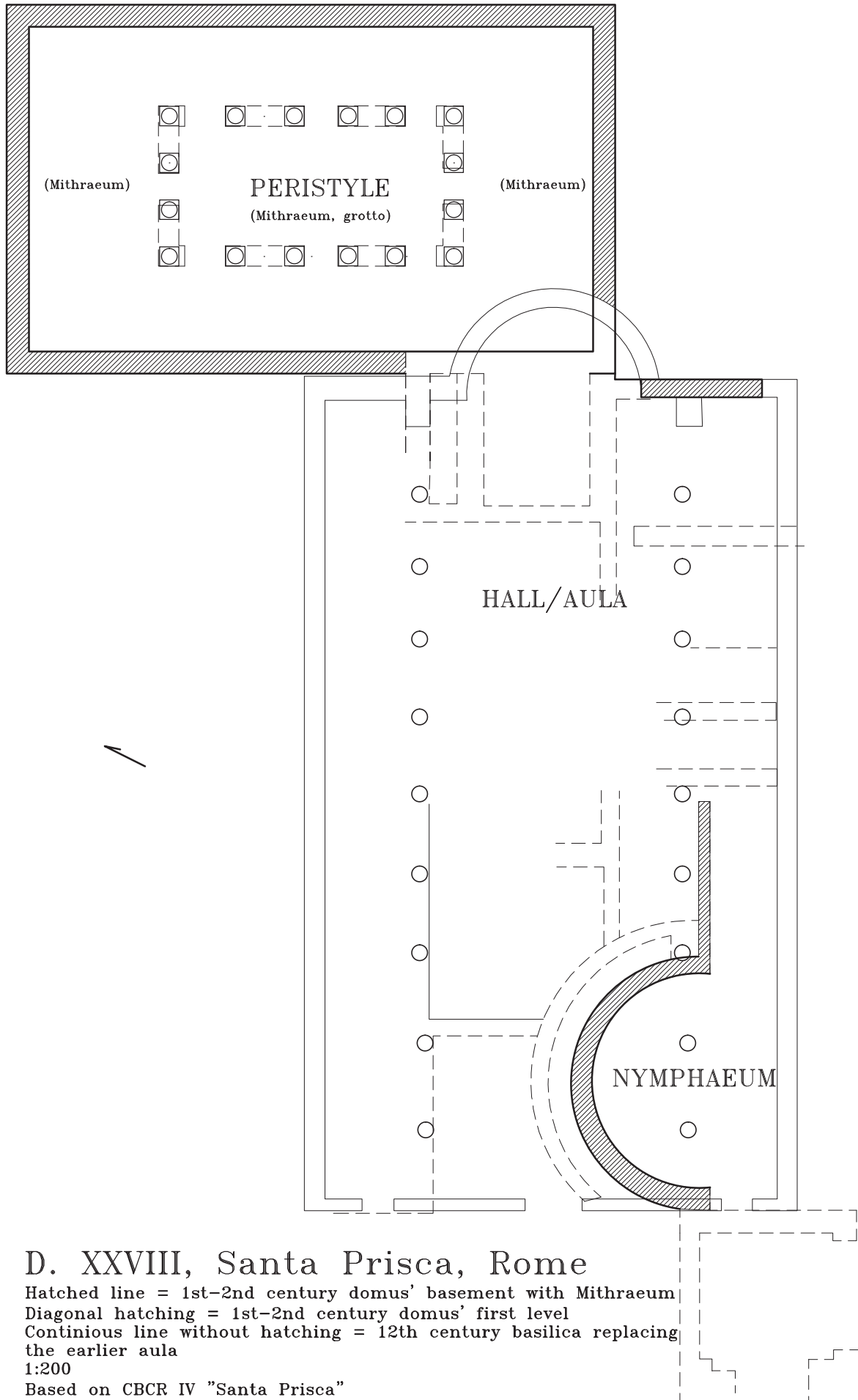
† = burials, 2nd to 4th century



## D. XXVII, SS. Quattro Coronati, Rome

The Leonine (Leo IV 847–855) basilica and the preceding structures of the domus (diagonal hatching), 1:400

Based on Barelli 2016, 2009 2008 and CBCR Vol. IV "SS. Quattro Coronati" J. Heikonen 2016



### D. XXVIII, Santa Prisca, Rome

Hatched line = 1st-2nd century domus' basement with Mithraeum  
 Diagonal hatching = 1st-2nd century domus' first level  
 Continuous line without hatching = 12th century basilica replacing the earlier aula  
 1:200  
 Based on CBCR IV "Santa Prisca"



Map I  
Rome of Constantine  
Juhana Heikonen 2015





**MAP II**  
**The Mithraeums, Juhana Heikonen 2016**


Map II shows the known Roman Mithraeums with the density map (grid 250×250m) of the known domus in LTUR. In contrast to Map V, the situation seems to be far less dependent of the residential areas.


Regio, Mithraeum, Location on the map (+ location in a structure)

- II MITHRA (S. STEFANO ROTONDO) 1 (barracks)
- III MITHRA (S. CLEMENS) 2 (domus)
- III MITHRA (THERMAE TITI) 3 (baths)
- V MITHRA (VIA PASSALACQUA 20) 4 (insula)
- V MITHRA, SPELAEUM (VIA G. LANZA 128) 5 (domus)
- V MITHRA (HORTI LAMIANI) 6 (domus/horti)
- V MITHRA (OSP. DI S. GIOVANNI SUL CELIO) 7 (domus)
- VI MITHRA (AEDES HERCULIS ET DIONYSII) 8 (temple)
- VI MITHRA (DOMUS NUNNII) 9 (domus)
- VI MITHRA (VIGNA MUTI) 10 (?)
- VI MITHRA (PALAZZO BARBERINI) 11 (nymphaeum/domus)
- IX MITHRA, SPELAEUM (P. DELLA CANCELLERIA) 12 (domus)
- XI MITHRA, ANTRUM (CIRCUS MAXIMUS) 13 (circus)
- XII MITHRA, SPELUNCA 14 (baths)
- XIII MITHRA (S. PRISCA) 15 (domus)
- XIII MITHRA (S. SABA) 16 (domus)

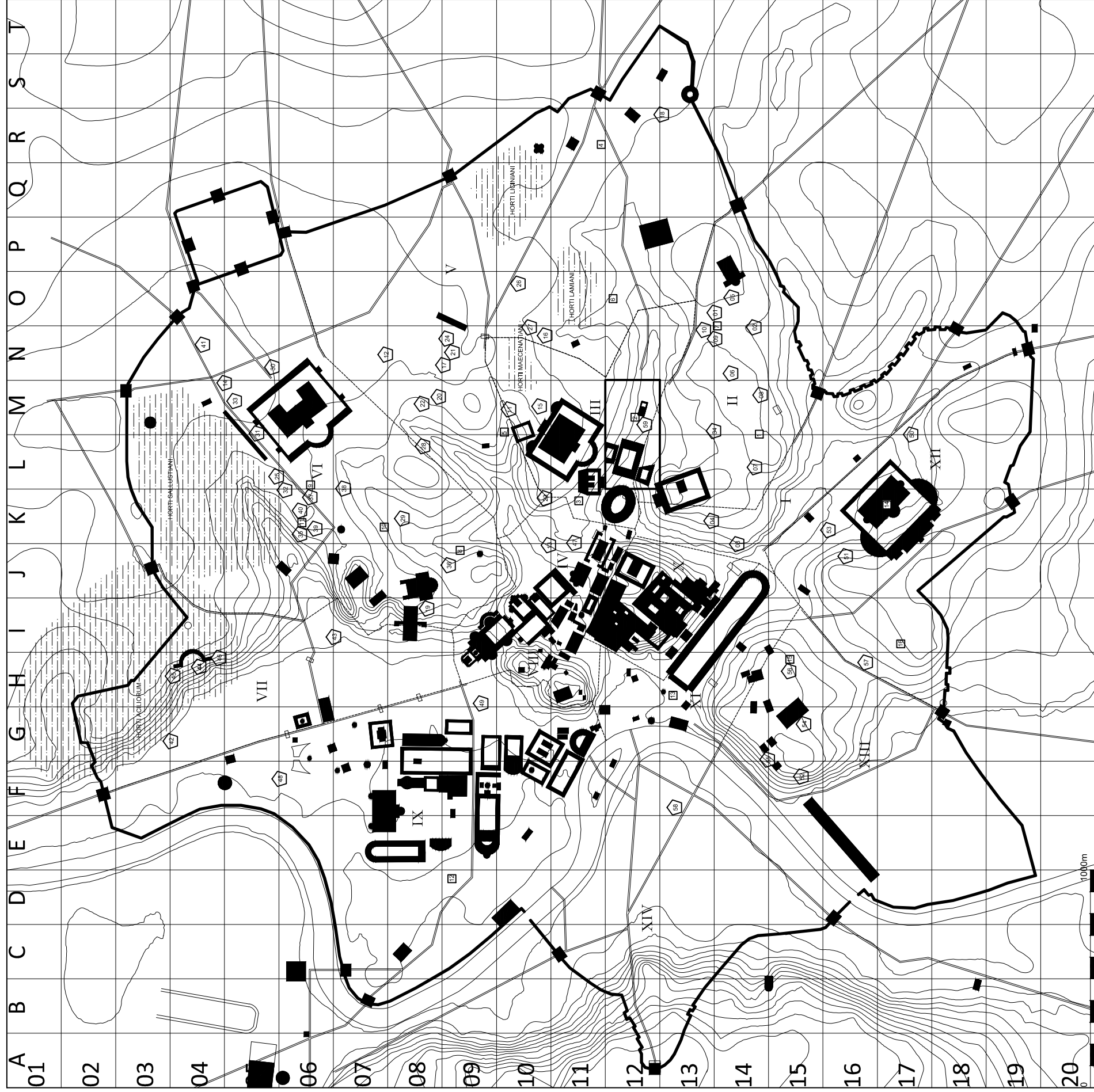
 1 domus/ $\frac{1}{16}$  km<sup>2</sup>

 3 domus/ $\frac{1}{16}$  km<sup>2</sup>

 2 domus/ $\frac{1}{16}$  km<sup>2</sup>

 4 domus/ $\frac{1}{16}$  km<sup>2</sup>

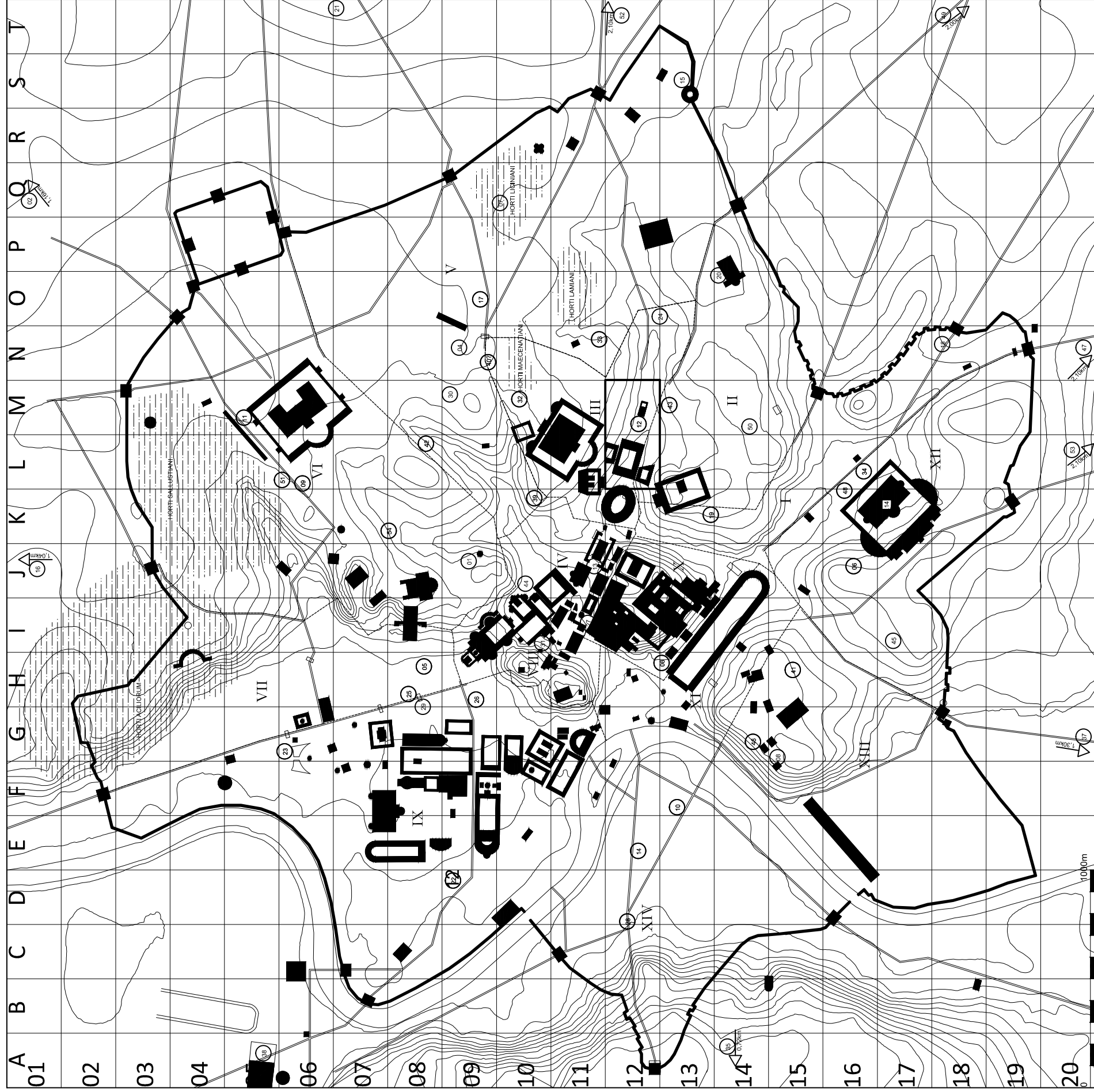




Map III, The Roman Domus and Mithraeums According to LTUR, 1:20000, Juhana Heikonen 2015

<ul style="list-style-type: none"> <li>☞ Domus with identifiable remains from I-V cent.</li> <li>☞ Mithraeum with identifiable remains</li> <li>☞ Domus, location on the map</li> </ul>	<ul style="list-style-type: none"> <li>V NAERATIUS CEREAUS 22</li> <li>V L. FABIVS GALLVS 23</li> <li>V T. FLAVIVS TIBERIANVS 24</li> <li>V GABINII 25</li> <li>V IUNIA PROC. 26</li> <li>V VETTIVS AGORIVS PRAETEXTATVS 27</li> <li>V PVDENTIS 28</li> <li>V AEMILIA PAVLINA ASIATICA 29</li> <li>V M. AEMILIVS AEMILIANVS 14</li> <li>V A. ANNICIVS PLOCAMVS 30</li> <li>V AVIDIVS QVIETVS 19</li> <li>V CYRIACI 31</li> <li>V T. FLAVIVS SABINVS 32</li> <li>V ALFENIVS CAEIONIVS IVLIANVS S. CAMENIVS 35</li> <li>V T. IVLIVS FRVGI 36</li> <li>V NUMMII 37</li> <li>V VVLCACIVS RVFINVS 38</li> <li>V SPVRIVS MAXIMVS 39</li> <li>V Q. VALERIVS VEGETVS 40</li> <li>IX AVIANIVS VINDICIANVS 41</li> <li>V VII AFRICANVS 42</li> <li>V VII C. FVLVIVS PLAVTIANVS 43</li> </ul>	<ul style="list-style-type: none"> <li>VII PINCIANA 44</li> <li>VII POSTVMII 45</li> <li>VII SEX. PETRONIVS PROBVVS 46</li> <li>IX ARADII 48</li> <li>IX TVRCII (2) 49</li> <li>XII AIACIVS CENSORINVS 50</li> <li>XII L. FABIVS CILO 51</li> <li>XII SEPTEM PATHORVM 53</li> <li>XIII CAECINA DEGIVS ALBINVS IVNIOR 54</li> <li>XIII COSMVS 55</li> <li>XIII L. LICINIVS SVRA 56</li> <li>XIII FLAVIVS IVNIVS QVARTVS PALLADIVS 57</li> <li>XIII PACTVMELLA LVCILLA 52</li> <li>XIV CAECILII 58</li> </ul>	<ul style="list-style-type: none"> <li>VI MITHRA (AEDES HERCVLIVS ET DIONYSII) 8</li> <li>VI MITHRA (DOMVS NUNNII) 9</li> <li>VI MITHRA (VIGNA MUTI) 10</li> <li>VI MITHRA (PALAZZO BARBERINI) 11</li> <li>IX MITHRA, SPELAEVM (P. DELLA CANCELLERIA) 12</li> <li>XI MITHRA, ANTRVM (CIRCVS MAXIMVS) 13</li> <li>XII MITHRA, SPELVNCA 14</li> <li>XIII MITHRA (S. PRISCA) 15</li> <li>XIII MITHRA (S. SABA) 16</li> </ul>
<ul style="list-style-type: none"> <li>II M. ANNIJ VERI 1</li> <li>II FAVSTAE 2</li> <li>II GAVDNTIVS 34</li> <li>II GREGORIVS I (ANCIJ PETRONII ?) 3</li> <li>II SS. IOHANNIS ET PAVLI 4</li> <li>II LATERANI 5</li> <li>II L. MARIVS MAXIMVS PERPETVVS AVRELIANVS 6</li> <li>II PHILIPPI 7</li> <li>II Q. AVRELIVS SYMMACHVS S. EVSEBIVS 8</li> <li>II VALERII 9</li> <li>II QVINTILORVM 10</li> <li>III C. PLINIVS CAECILIVS SECVNDVS 11</li> <li>III S. CLEMENTIS 59</li> <li>IV L. OCTAVIVS FELIX 12</li> <li>IV ATTIVS INSTEVVS TERTVLLVS 47</li> <li>IV ALBINVS 13</li> <li>V L. AEMILIVS IVNCVS 15</li> <li>V ALBINOVANVS PEDO 16</li> <li>V ARIPPORVM ET VLPIORVM VIBIORVM 17</li> <li>V AVFIDIA CORNELIA VALENTILLA 18</li> <li>V FLAVIVS ANICIVS AVCHENIVS BASSVS 20</li> <li>V IUNIVS BASSVS 21</li> </ul>	<ul style="list-style-type: none"> <li>II MITHRA (S. STEFANO ROTONDO) 1</li> <li>III MITHRA (S. CLEMENS) 2</li> <li>III MITHRA (THERMAE TITI) 3</li> <li>V MITHRA (VIA PASSALACQVA) 20) 4</li> <li>V MITHRA, SPELAEVM (VIA G. LANZA 128) 5</li> <li>V MITHRA (HORTI LAMIANI) 6</li> <li>V MITHRA (OSP. DI S. GIOVANNI SUL CELIO) 7</li> </ul>	<ul style="list-style-type: none"> <li>Regio, Mithraeum, Location on the map</li> </ul>	





Map IV, The Roman Churches from Constantine to Sixtus III, 1:20000, Juhana Heikonen 2015

Regio, Church, Location on the map

- 1 Sant' Agata dei Goti J-09
- 2 Sant' Agnese fuori le mura A
- 3 Sant' Anastasia al Palatino H-13
- 4 Sant' Andrea in Catabarbara N-09
- 5 Santi Apostoli A H-08
- 6 Santa Balbina J-16
- 7 Santa Bibiana O-10
- 8 Santi Bonifacio e Alessio G-15
- 9 San Caio in Via Porta Pia L-06
- 10 Santa Cecilia in Trastevere F-13
- 11 San Ciriaco M-05
- 12 San Clemente M-12
- 13 Santi Cosma e Damiano J-11
- 14 San Crisogono E-12
- 15 Santa Croce in Gerusalemme S-13
- 16 Sant' Ermete
- 17 Sant' Eusebio O-09
- 18 San Giovanni a Porta Latina N-18
- 19 Santi Giovanni e Paolo K-13
- 20 San Giovanni in Laterano O-14
- 21 San Lorenzo fuori le mura A T-07
- 22 San Lorenzo in Damaso D-09
- 23 San Lorenzo in Lucina G-06
- 24 Santi Marcellino e Pietro

- 25 San Marcello al Corso H-08
- 26 San Marco H-09
- 27 Santa Maria Antiqua I-11
- 28 Santa Maria in Trastevere D-12
- 29 Santa Maria in Via Lata H-08
- 30 Santa Maria Maggiore M-09
- 31 Santi Martina e Luca I-10
- 32 San Martino ai Monti B M-10
- 33 San Matteo in Merulana N-11
- 34 Santi Nereo e Achilleo sulla via A. L-16
- 35 San Pancrazio
- 36 San Paolo alle Tre Fontane
- 37 San Paolo fuori le mura
- 38 San Pietro in Vaticano A-05
- 39 San Pietro in Vincoli B K-10
- 40 Santa Prassede A ? N-09
- 41 Santa Prisca H-15
- 42 Santa Pudenziana L-08
- 43 Santi Quattro Coronati M-13
- 44 Santi Quirico e Giulitta J-10
- 45 San Saba I-17
- 46 Santa Sabina G-14
- 47 San Sebastiano fuori le mura
- 48 San Sisto Vecchio K-16
- 49 Santo Stefano in Via Latina

- 50 Santo Stefano Rotondo M-14
- 51 Santa Susanna L-06
- 52 Bas. Tor de'Schiavi (B. dei Gord.)
- 53 Bas. Via Ardeatina
- 54 San Vitale K-08





**MAP V**

The churches from the 4th throughout the 6th centuries in relation to the domus  
Juhana Heikonen 2016.

Map V shows the known churches in relation to the density of the domus in Rome.

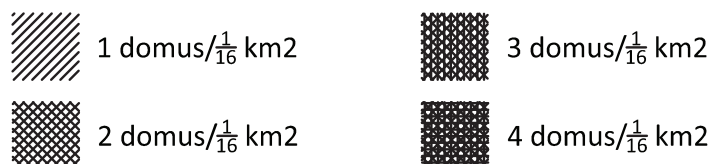


TABLE I, THE ROMAN BASILICAS. See Appendix II for plans (Brandenburg 2003).

	year	nave length	nave width	nl/nw	nave height	nw/nh	transept	aisle width	2nd aisle width	Em	N	En	Am	Ap	C	Qd	function
Basilica Iulia	12 BC	82,00	16,00	5,13				7,50		x		L	x	0			civic
Basilica Paulli	34 BC	45,00	10,50	4,29	24,00	0,44		4,50		x		L	x	0	x		civic
Basilica Ulpia	112	88,00	25,00	3,52	25,00	1,00		6,50		x		L	x	2	x		civic
Basilica Maxentii I	306-311	81,30	24,00	3,39	35,00	0,69		16,00			x	S		1			civic
Basilica Maxentii II	311-313	81,30	24,00	3,39	35,00	0,69		16,00			x	L		2	x		civic
San Giovanni in Laterano	312-313	90,60	18,90	4,79	24,90	0,76	62,40×15,30	8,10	7,50		x	S		1	x	x	church
San Pietro	330	90,95	24,45	3,72	32,17	0,76	87,95×16,82	8,44	8,66		x	S	X	1	x	x	martyrium
San Sebastiano	313-337	58,40	13,60	4,29	?	?		7,40			x	S	X	1	x		martyrium
SS. Marcellino e Pietro	320	88,20	12,20	7,23	?	?		6,70			x	S	X	1	x		martyrium
San Lorenzo f/m	330	88,00	16,20	5,43	?	?		8,00			x	S	X	1	x		martyrium
San Clemente	392-417	35,93	15,32	2,35	13,50	1,13		5,60			x	S		1	x	x	church
San Paolo f/m	384	86,70	23,80	3,64	?	?	71,00×22,30	8,90	8,90		x	S		1	x	x	church
Santi Nereo e Achilleo	ca. 390	21,00	10,00	2,10	?	?		4,40			x	S		1	x		church
San Sisto Vecchio	399-402	35,80	10,90	3,28	?	?		3,90				S		1	x	x	church
SS. Giovanni e Paolo	ca. 400	40,50	13,00	3,12	?	?		6,50			x	S		1	x	x	church
San Pietro in Vincoli A	400	51,60	16,60	3,11	16,30	1,02		5,80			?	S		1	x		church
San Vitale	402-417	42,20	14,40	2,93	17,20	0,84		?			x	S		1	x		church
Santa Sabina	422-432	47,00	13,40	3,51	18,50	0,72		4,90			x	S		1	x		church
Santa Maria Maggiore	432-440	71,56	15,60	4,59	18,35	0,85		6,60			x	S		1	x	x	church
San Lorenzo in Lucina	400-450	43,84	13,25	3,31	13,20	1,00		4,80				S		1			church
Santo Stefano in via Latina	ca. 450	28,80	8,80	3,27	?	?		5,20			x	S		1	x		church
Santa Agata dei Goti	ca. 450	22,21	9,85	2,25	13,00	0,76		3,75			x	S		1	x	x	church
San Pietro in Vincoli B	ca. 450	51,60	16,60	3,11	16,30	1,02	32,80×11,60	5,80			?	S		1			church

Em=emporio level

N=narthex

En=entrance side, L=long side, S=short side

Am=ambulatory

Ap=apse, number

C=clerestory wall

Qd=atrium

**TABLE II, SOME MEDITERRANEAN BASILICAS AS SET IN GROUPS**

**1A Short side entrance, apse and atrium**

Parenzo (Balkans)  
Tebessa (Egypt)  
San Clemente (Rome)  
Santa Maria Maggiore (Rome)  
Santa Agata dei Goti (Rome)  
San Sisto Vecchio (Rome)  
SS. Giovanni e Paolo (Rome)

**1B Short side entrance, apse and no atrium**

Trier (Germany)  
Domus Augustana (Rome)  
San Giovanni Evangelista (Ravenna)  
San Apollinare Nuovo (Ravenna)  
Saint Paul and Moses  
San Vitale (Rome)  
Santa Sabina (Rome)  
Santo Stefano in via Latina (Rome)  
Basilica Maxentii I (Rome)  
Saint John Studios (Istanbul)  
Basilica of Acheropietos (Greece)  
San Pietro in Vincoli A (Rome)  
San Lorenzo in Lucina (Rome)  
SS. Nereo e Achilleo (Rome)

**2A Short side entrance, apse, transept and atrium**

San Paolo fm (Rome)  
San Pietro (Rome)  
San Giovanni in Laterano (Rome)

**2B Short side entrance, apse, transept and no atrium**

Saint John's (Turkey)  
Saint Mary's (Turkey)  
Qal'aat Sa'maan (Syria)  
Qualb Lozeh (Syria)  
San Pietro in Vincoli B (Rome)

**3A Short side entrance, ambulatory, and no atrium**

San Sebastiano (Rome)  
SS. Marcellino e Pietro (Rome)  
San Lorentzo fm (Rome)

**3B Long side entrance, ambulatory and atrium**

Caesareum (Israel)  
Lepcis Magna (Libya)

**3C Long side entrance, ambulatory and no atrium**

Basilica Ulpia (Rome)

**4 Short side entrance, surrounding aisles, no apse and no atrium**

Pompeii (Italy)

**5A Long side entrance, surrounding aisles, apse and no atrium**

Augusta Raurica (Switzerland)  
Basilica Maxentii II (Rome)

**5B Long side entrance, two aisles, no apse and no atrium**

Bosra (Syria)  
Palmyra (Syria)  
Doclea (Serbia)

**5C Long side entrance, surrounding aisles, no apse and no atrium**

Cosa (Italy)  
Ostia (Rome)  
Smyrna (Turkey)  
Ephesos (Turkey)  
Basilica Iulia (Rome)  
Basilica Paulli (Rome)

**TABLE III, THE ROMAN DOMUS (WITH ARCH. AND LIT. EVIDENCE) ACCORDING TO LTUR, MAP III**

<u>Nr.</u>	<u>Domus</u>	<u>Map</u>	<u>Regio</u>	<u>Century</u>
1	(M. ANNII) VERI	O-14	II	2.
2	FAUSTA	N-14	II	1.-4.
3	GREGORIUS I (ANCII PETRONII ?)	J-14	II	3.-4.
4	SS. IOHANNIS ET PAULI	K-13	I	4.
5	LATERANI	O-14	II	1.
6	L. MARIUS MAXIMUS PERPETUUS AURELIANUS	N-14	II	1.-2.
7	PHILIPPI	L-14	II	4.
8	Q. AURELIUS SYMMACHUS (S. EUSEBIUS)	J-14	II	5.
9	VALERII	N-14	II	?
10	QUINTILIORUM	N-13	II	2.-3.
11	C. PLINIUS CAECILIUS SECUNDUS	M-10	III	?
12	L. OCTAVIUS FELIX	N-07	IV	3.-4.
13	ALBINUS V. I.	J-10	IV	4.-5.
14	M. AEMILIUS AEMILIANUS (only a <i>fistula</i> )	M-05	VI	3.
15	L. AEMILIUS IUNCUS (only a <i>fistula</i> )	M-10	V	3.
16	ALBINOVANUS PEDO	N-10	V	?
17	ARIPPORUM ET ULPIORUM VIBIORUM (uncertain)	N-09	V	3.-4.
18	AUFIDIA CORNELIA VALENTILLA	R-13	V	3.
19	AVIDIUS QUIETUS	I-08	VI	1.-2.
20	FLAVIUS ANICIUS AUCHENIUS BASSUS	M-08	V	2.-4.
21	IUNIUS BASSUS	N-09	V	4.
22	NAERATIUS CEREALIS	M-08	V	4.
23	L. FABIVS GALLVS	K-10	V	?
24	T. FLAVIUS TIBERIANUS	N-09	V	2.-3.
25	GABINI	L-05	VI	5.
26	IUNIA PROC.	O-10	V	?
27	VETTIUS AGORIUS PRAETEXTATUS	N-10	V	4.
28	PUDENTIS	L-08	V	2.
29	AEMILIA PAULINA ASIATICA	K-06	VI	2.
30	A. ANNICES PLOCAMUS (only a <i>fistula</i> )	N-05	VI	1.
31	CYRIACUS	M-05	VI	4.
32	T. FLAVIUS SABINUS	K-06	VI	1.
33	T. FLAVIUS VEDIUS ANTONINUS	M-05	VI	4.
34	GAUDENTIUS	M-13	II	2.-3.
35	ALFENIUS CAEIONIUS IULIANUS S. CAMENIUS	K-06	VI	3.
36	T. IULIUS FRUGI	J-09	VI	?
37	NUMMII	K-06	VI	4.
38	VULCACIUS RUFINUS	L-07	VI	4.
39	SPURIUS MAXIMUS	K-06	VI	2.
40	Q. VALERIUS VEGETUS	K-06	VI	?
41	AVIANIUS VINDICIANUS	M-04	IX	4.
42	AFRICANUS	G-04	VII	1.
43	C. FULVIUS PLAUTIANUS	I-07	VII	3.-4.
44	PINCIANA	H-04	VII	4.-5.
45	POSTUMII	H-04	VII	?
46	SEX. PETRONIUS PROBUS	H-04	VII	rep.
47	ATTIUS INSTEIUS TERTULLUS	K-11	IV	4.-5.
48	ARADII	F-06	IX	?
49	TURCII (2)	H-09	IX	3.
50	AIACIUS CENSORINUS	M-17	XII	?
51	L. FABIVS CILO (CILONIS)	J-16	XII	3.-4.
52	PACTUMEIA LUCILLA	F-15	XIII	1.-4.
53	SEPTEM PATHORUM	K-16	XII	?
54	CAECINA DECIUS ALBINUS IUNIOR	G-15	XIII	?
55	COSMUS	G-15	XIII	?
56	L. LICINIUS SURA	H-15	XIII	2.
57	FLAVIUS IUNIUS QUARTUS PALLADIUS	H-16	XIII	5.
58	CAECILII	F-13	XIV	2.-3.
59	CLEMENTIS	M-12	III	3.



TABLE IV, THE ROMAN CHURCHES AND TOPOGRAPHY FROM THE FIRST QUARTER OF THE FOURTH CENTURY TO THE SECOND QUARTER OF THE SIXTH CENTURY RELATING TO MAP IV													
Nr.	Church	Map	Regio	Cent./Quarter	Type	Q.por.	Mith.	Preceding	Pre. domus	Loc. in domus/villa/ins.	Titulus name	Pu./Pri.	Urban surroundings
1	Sant' Agata dei Goti	J-09	VI	5. C., 3. QRT	basilica	x						4	
2	Sant' Agnese fuori le mura A			4. C., 2. QRT	dea. bas.							5	
3	Sant' Anastasia al Palatino	H-13	XI	4. C., 3. QRT	basilica			insula			Anastasiae	1	Circus Maximus, Palatinus
4	Sant' Andrea in Catabarbara	N-09	V	5. C., 3. QRT	aula			domus	21		Macellum Liviae	3	Macellum Liviae
5	Sant' Apostoli A	H-08	VII	6. C., 2. QRT	basilica			domus			Apostolorum/Eudoxiae	3	Temp. Serapidis
6	Santa Balbina	J-16	V	5. C., 1. QRT	aula			domus	51	aula	Balbinae	3	Ther. Antoniniane
7	Santa Bibiana	O-10	XII	5. C., 4. QRT	?			domus				4	
8	Santi Bonifacio e Alessio	G-15	XIII	5. C., 1. QRT	?			domus	37		Gaii?	3	Temp. Consi, Iunone, Iovis
9	San Caio in Via Porta Pia	L-06	VI	5. C., 1. QRT	basilica		x	insula			Caeciliae/Transstiberim	4	Ther. Diocletiani
10	Santa Cecilia in Trastevere	F-13	XIV	5. C., 1. QRT	basilica			domus			Cyriaci/Quiriaci	3	Ther. Diocletiani, Por. Milarenensis
11	San Ciriaco	M-05	VI	5. C., 1. QRT	?			domus			Clementis	3	Ludus Magnus
12	San Clemente	M-12	III	4. C., 4. QRT	basilica	x	x	temple	59			2	Temp. Veneris & Romae, Bas. Maxentii
13	Santi Cosma e Damiano	J-11	IV	6. C., 2. QRT	aula			domus			Chrysogoni	4	
14	San Crisogono	E-12	XIV	4. C., 1. QRT	aula			domus				3	Sessorium
15	Santa Croce in Gerusalemme	S-13	V	4. C., 2. QRT	basilica			domus	Sessoriana	aula		5	
16	Sant' Ermete			4. C., 4. QRT	aula			domus		nymphaeum		3	Macellum Liviae
17	Sant' Eusebio	O-09	V	5. C., 1. QRT	?			domus			Eusebi/Eusebii	3	Porta Latinae
18	San Giovanni a Porta Latina	N-18	I	5. C., 4. QRT	basilica			domus				3	Temp. Divi Claudii
19	Santi Giovanni e Paolo	K-13	II	5. C., 1. QRT	basilica	x		insula			Pammachi/Iohannis et Pauli	3	
20	San Giovanni in Laterano	O-14	II	4. C., 1. QRT	basilica	x		barracks				4	
21	San Lorenzo fuori le mura A	T-07		4. C., 2. QRT	basilica							5	
22	San Lorenzo in Damaso	D-09	IX	4. C., 3. QRT	basilica		x	domus			Damasi	3	Stad. Domitiani, Teat. Pompeii
23	San Lorenzo in Lucina	G-06	IX	4. C., 3. QRT	basilica			insula			Lucinae	3	Ara Pacis, Temp. Solis
24	Santi Marcellino e Pietro			4. C., 2. QRT	dea. bas.						Nicomedis	5	
25	San Marcello al Corso	H-08	VII	4. C., 4. QRT	basilica			domus			Marcelli	3	Arcus Diocletiani
26	San Marco	H-09	IX	4. C., 2. QRT	aula			domus		aula	Marci	3	Temp. Divorum
27	Santa Maria Antiqua	I-11	X	6. C., 1. QRT	basilica			domus		atrium		1	Forum, Palatium, Lacus Iuturnae
28	Santa Maria in Trastevere	D-12	XIV	4. C., 3. QRT	?						Iulii/Iulii et Callisti	4	
29	Santa Maria in via Lata	H-08	IX	5. C., 3. QRT	?			insula		portico		4	
30	Santa Maria Maggiore	M-09	V	5. C., 2. QRT	basilica	x		domus	20			3	Forum, Fora Imperatorum
31	Santi Martina e Luca	I-10	VIII	6. C., 4. QRT	?			civic			Equitii	4	
32	San Martino ai Monti B	M-10	III	6. C., 1. QRT	?			civic			Matthaei	4	
33	San Matteo in Merulana	N-11	V	5. C., 1. QRT	?			?			Fascioiae/Nerei et Achillei	2	Ther. Antoniniane
34	Santi Nereo e Achilleo sulla Via A.	L-16	XII	4. C., 4. QRT	?			catacomb				5	
35	San Pancrazio			6. C., 1. QRT	basilica			catacomb				5	
36	San Paolo alle Tre Fontane			6. C., 3. QRT	?			catacomb				5	
37	San Paolo fuori le mura			4. C., 4. QRT	basilica	x						5	
38	San Pietro in Vaticano	A-05		4. C., 2. QRT	basilica	x						5	
39	San Pietro in Vincoli B	K-10	V	5. C., 3. QRT	basilica			domus			Eudoxiae	4	
40	Santa Prassede A?	N-09	V	4. C., 4. QRT	?			?			Praxedis	4	
41	Santa Prisca	H-15	XIII	5. C., 1. QRT	?			domus			Priscae	3	Ther. Decianae, Temp. Dianae
42	Santa Pudenziana	L-08	V	4. C., 3. QRT	basilica	x	x	domus	C. M. P. Cornelianus	private bath?	Pudentis	4	
43	Santi Quattro Coronati	M-13	II	5. C., 2. QRT	aula	x		domus		aula	Aemilianae/III Coraoborum	4	
44	Santi Quirico e Giulitta	J-10	VIII	6. C., 2. QRT	aula			domus		aula	Albinus V. I.	1	Fora Imperatorum
45	San Saba	I-17	XII	4. C., 3. QRT	aula		x	domus		aula		4	
46	Santa Sabina	G-14	XIII	5. C., 2. QRT	basilica		x	domus	55		Sabinae	3	Temp. Iunone, Iovis
47	San Sebastiano fuori le mura			4. C., 3. QRT	dea. bas.			domus			Crescentianae/Sixti	5	
48	San Sisto Vecchio	K-16	XII	4. C., 4. QRT	basilica	x		villa		aula		4	
49	Santo Stefano in Via Latina			5. C., 3. QRT	basilica			barracks				5	
50	Santo Stefano Rotondo	M-14	II	5. C., 3. QRT	round		x	barracks				4	
51	Santa Susanna	L-06	VI	4. C., 3. QRT	basilica			domus			Susannae/Gaii	4	
52	Bas. Tor de'Schiavi (B. dei Gord.)			4. C., 2. QRT	dea. bas.							5	
53	Bas. Via Ardeatina			4. C., 2. QRT	dea. bas.							5	
54	San Vitale	K-08	VI	5. C., 1. QRT	basilica		x				Vestinae/Vitalis	4	

Nr. = Number on the map. Church = The modern name, Cen. Quarter = Time of construction, Type = single nave/basilica, QPor. = Quadrifortis (x=yes), Mith. = Mithraeum (x=yes), Preceding = the previously existing structure  
Pre. Domus = name of the domus in Table III. Loc. in domus/villa/ins. = the loc. of the church in the previously existing structure, Titulus name = name of the titulus, Pu./Pri. = level of urban activity, 1=very public, 4=very private, 5=outside

**TABLE V, LIST OF CHURCHES 200-550 ATTRIBUTED TO POPES**

BISHOP	BASILICA	ORATORY	MONASTERY	FINANCED BY A PRIVATE PERSON
Callixtus	1			
Marcellus	1			
Silvester	2			Titulus Equitii, Equitus/Pammachius
Marcus	2			
Liberius	1			
Felix I	1			
Damasus	2			
Anastasius	1			
Innocentius	1			Titulus Vestinae, Vestina
Bonifacius		1		
Xystus	2		1	
Leo	2			Santo Stefano in Via Latina, Demetrias
Hilarius			1	
Simplicius	4			
Felix III	1			
Symmachus	2			
Felix IV	2			
Vigilius			1	